

Engineering Report on the Construction and Testing of Production Wells P-3 through P-7 Fort Myers, Florida



Prepared for the



Volume I of III

Prepared by



March 2001
157775



City of Fort Myers, Florida

Albert Abdo, Jr.
Public Works Director

2200 Second Street
P.O. Box 2217

Ft. Myers, FL 33902-2217
Telephone (239)332-6854

Fax (239)332-6604

E-mail: aabdp@cityofmyers.com

January 22, 2004

Ms. Cindy Bevier
South Florida Water Management District
MSC 4350
3301 Gun Club Road
West Palm Beach, FL 33406

Re: Grant No. DG040636, Reverse Osmosis WTP and Floridan Aquifer Wellfield Expansion

Dear Ms. Bevier:

As outlined and requested in a letter received from Ms. Cynthia Houston dated December 10, 2003, I am enclosing a copy of CH2MHILL's Engineering Report on the Construction and Testing of Production Wells P-3 through P-7 that can be used to update the Floridan aquifer database, DBHYDRO.

Please feel free to contact me if you require any additional information.

Sincerely,

Albert Abdo, Jr.
Public Works Director

AA:vjhs:H:\Water Plant\SFWMD Floridan Database Information Request.doc
Enclosure

CC: Byron Weightman, Water Plant Superintendent

Contents

<u>Section</u>	<u>Page</u>
List of Acronyms and Abbreviations	vii
1 Introduction.....	1-1
1.1 Historical Background.....	1-1
2 Well Construction	2-1
2.1 Well P-1 Modification	2-1
2.2 Well P-3 Construction.....	2-2
2.3 Well P-4 Construction.....	2-6
2.4 Well P-5 Construction.....	2-9
2.5 Well P-6 Construction.....	2-12
2.6 Well P-7 Construction.....	2-15
3 Geology and Hydrogeology	3-1
3.1 Fort Myers Artesian Aquifer Wellfield	3-1
3.2 Lithostratigraphic Descriptions.....	3-1
3.3 Undifferentiated Holocene and Pleistocene Series.....	3-1
3.3.1 Pliocene Series	3-4
3.3.2 Miocene Series	3-4
3.3.3 Oligocene Series	3-5
4 Hydrogeologic Testing.....	4-1
4.1 Formation Sampling.....	4-1
4.2 Geophysical Logging	4-1
4.2.1 Video Logging	4-5
4.3 Reverse-Air Drilling Specific Capacity Tests.....	4-5
4.3.1 Well P-3 Drilling Specific Capacity Testing	4-6
4.3.2 Well P-4 Drilling Specific Capacity Testing	4-6
4.3.3 Well P-5 Drilling Specific Capacity Testing	4-9
4.3.4 Well P-6 Drilling Specific Capacity Testing	4-12
4.3.5 Well P-7 Drilling Specific Capacity Testing	4-12
4.4 Packer Test.....	4-14
4.5 Aquifer Performance Testing.....	4-14
4.5.1 Well P-3 Aquifer Performance Test	4-14
4.5.2 Well P-4 Aquifer Performance Test	4-16
4.5.3 Well P-5 Aquifer Performance Test	4-18
4.5.4 Well P-6 Aquifer Performance Test	4-20
4.5.5 Well P-7 Aquifer Performance Test	4-20
4.6 Summary of Calculated Aquifer Characteristics	4-22

5	Water Quality Testing	5-1
	5.1 Well P-3 Water Quality.....	5-1
	5.2 Well P-4 Water Quality.....	5-3
	5.3 Well P-5 Water Quality.....	5-5
	5.4 Well P-6 Water Quality.....	5-5
	5.5 Well P-7 Water Quality.....	5-8
	5.6 Ambient Water Quality Results	5-8
	5.7 Wellhead Bacteriological Analysis Results.....	5-8
6	Well Acidization	6-1
	6.1 Well P-2 Acidization	6-1
	6.2 Well P-3 Acidization	6-1
	6.3 Well P-4 Acidization	6-1
	6.4 Well P-5 Acidization	6-2
	6.5 Well P-6 Acidization	6-2
	6.6 Well P-7 Acidization	6-3
7	Groundwater Modeling	7-1
	7.1 Background Information – Original Model.....	7-1
	7.2 Numerical Model Calibration – Wells P-1 through P-7.....	7-1
	7.3 Semi-Analytical Model Calibration	7-7
	7.4 MODFLOW Simulated Aquifer Response.....	7-7
	7.4.1 Scenario 1 – Seven Wells Pumping 1.3 mgd Each for 90 Days	7-8
	7.4.2 Scenario 2 – Seven Wells Pumping 2.0 mgd Each for 90 Days	7-8
	7.5 AQUIFERWIN32 Simulated Aquifer Response.....	7-11
	7.6 Modeling Results Summary.....	7-13
8	Summary and Recommendations	8-1
	8.1 Summary.....	8-1
	8.2 Recommendations.....	8-1
9	Bibliography and References Cited	9-1

List of Appendixes:

Volume I

- A Regulatory Permits
- B Lithologic Description of Formation Samples
- C Summary of Construction Activities
- D Daily Construction Reports
 - D.1 Well P-1 Daily Construction Reports
 - D.2 Well P-2 Daily Construction Reports
 - D.3 Well P-3 Daily Construction Reports
 - D.4 Well P-4 Daily Construction Reports
 - D.5 Well P-5 Daily Construction Reports
 - D.6 Well P-6 Daily Construction Reports
 - D.7 Well P-7 Daily Construction Reports

List of Appendixes (continued):

Volume I (continued)

- E Casing Mill Certificates
- F Geophysical Logs (see Volume II)
- G Video Surveys
 - G.1 Video Survey Summary Forms
 - G.2 Video Survey (see Volume III for video tapes)
- H Pumping Tests Water Level Data
- I Pumping Test Analyses Plots
- J Ambient Water Quality Results
 - J.1 Well P-3 Ambient Water Quality Results
 - J.2 Well P-4 Ambient Water Quality Results
 - J.3 Well P-5 Ambient Water Quality Results
 - J.4 Well P-6 Ambient Water Quality Results
 - J.5 Well P-7 Ambient Water Quality Results
- K Bacteriological Analysis Results for the Temporary Wellheads

Volume II

- F Geophysical Logs

Volume III

- G.2 Borehole Video Survey - Video Tapes

List of Tables

<u>Number</u>		<u>Page</u>
2-1	Summary of Casing Setting Depths and Cement Quantities; Production Well P-3.....	2-5
2-2	Summary of Casing Setting Depths and Cement Quantities; Production Well P-4.....	2-6
2-3	Summary of Casing Setting Depths and Cement Quantities; Production Well P-5.....	2-11
2-4	Summary of Casing Setting Depths and Cement Quantities; Production Well P-6.....	2-14
2-5	Summary of Casing Setting Depths and Cement Quantities; Production Well P-7.....	2-15
4-1	Well P-3 Geophysical Logging Activities.....	4-2
4-2	Well P-4 Geophysical Logging Activities.....	4-2
4-3	Well P-5 Geophysical Logging Activities.....	4-4
4-4	Well P-6 Geophysical Logging Activities.....	4-4
4-5	Well P-7 Geophysical Logging Activities.....	4-5
4-6	Well P-3 Reverse-Air Drilling Specific Capacity Tests Data Summary	4-6
4-7	Well P-4 Reverse-Air Drilling Specific Capacity Tests Data Summary	4-9
4-8	Well P-5 Reverse-Air Drilling Specific Capacity Tests Data Summary	4-9
4-9	Well P-6 Reverse-Air Drilling Specific Capacity Tests Data Summary	4-12
4-10	Well P-7 Reverse-Air Drilling Specific Capacity Tests Data Summary	4-12
4-11	Summary of Aquifer Test Results	4-25
5-1	Well P-3 Pilot Hole Water Quality Results	5-3
5-2	Well P-4 Pilot Hole Water Quality Results	5-3
5-3	Well P-5 Pilot Hole Water Quality Results	5-5

5-4	Well P-6 Pilot Hole Water Quality Results	5-5
5-5	Well P-7 Pilot Hole Water Quality Results	5-8
5-6	Final Water Quality Results Summary	5-10
7-1	Comparison of Aquifer Test Results with Model Transmissivity Distribution	7-2
7-2	MODFLOW Numerical Model Results	7-9
7-3	AQUIFERWIN Analytical Model Results	7-11

List of Figures

<u>Number</u>		<u>Page</u>
1-1	RO WTP Wellfield - Wells P-1 to P-7 Location Map	1-2
2-1	Well P-1 Construction Modification Details	2-3
2-2	Well P-3 Construction Details	2-4
2-3	Temporary Wellhead Completion Details	2-7
2-4	Well P-4 Construction Details	2-8
2-5	Well P-5 Construction Details	2-10
2-6	Well P-6 Construction Details	2-13
2-7	Well P-7 Construction Details	2-16
3-1	Location of Geologic Cross Section A-A'	3-2
3-2	Geologic Cross Section A-A' and General Well Construction	3-3
4-1	Wells P-3 through P-7 Gamma Ray Log Correlation	4-3
4-2	Well P-3 Reverse-Air Specific Capacity Results	4-7
4-3	Well P-4 Reverse-Air Specific Capacity Results	4-8
4-4	Well P-5 Reverse-Air Specific Capacity Results	4-10
4-5	Well P-6 Reverse-Air Specific Capacity Results	4-11
4-6	Well P-7 Reverse-Air Specific Capacity Results	4-13
4-7	P-3 Pumping Test Water Level Summary Data	4-15
4-8	P-4 Pumping Test Water Level Summary Data	4-17
4-9	P-5 Pumping Test Water Level Summary Data	4-19
4-10	P-6 Pumping Test Water Level Summary Data	4-21
4-11	P-7 Pumping Test Water Level Summary Data	4-23
5-1	Well P-3 Pilot Hole Water Quality	5-2
5-2	Well P-4 Pilot Hole Water Quality	5-4
5-3	Well P-5 Pilot Hole Water Quality	5-6
5-4	Well P-6 Pilot Hole Water Quality	5-7
5-5	Well P-7 Pilot Hole Water Quality	5-9
7-1	Model Calibration Results of P-3 Observed Data from the P-4 Pump Test	7-3
7-2	Model Calibration Results of P-6 Observed Data from the P-5 Pump Test	7-4
7-3	Refined Grid Spacing for the Numerical Model Simulations	7-5
7-4	Model Layer 3 Hydrogeologic Parameter Distribution	7-6
7-5	Simulated Drawdown of Layer 3 for the 90-Day Withdrawal Scenario at 1.3 mgd per Well	7-9

7-6 Simulated Drawdown of Layer 3 for the 90-Day Withdrawal Scenario at
2.0 mgd per Well..... 7-10

7-7 Simulated Drawdown of Layer 3 for the 5-Year Withdrawal at 1.3 mgd per Well 7-12

List of Acronyms and Abbreviations

API	American Petroleum Institute
ASR	Aquifer storage and recovery
bls	Below land surface
DO	Dissolved oxygen
DWS	Drinking water standard
FAC	Florida Administrative Code
FDEP	Florida Department of Environmental Protection
FGS	Florida Geological Survey
ft	Feet
ft ² /d	Squared feet per day
gpd	Gallons per day
gpd/ft	Gallons per day per foot
gpm	Gallons per minute
MCL	Maximum contaminant level
μS/cm	Microseimans per centimeter
mg/L	Milligrams per liter
mgd	Million gallons per day
MWTP	Membrane water treatment plant
NA	Not analyzed
ND	Not detected
OD	Outside diameter
PCi/L	Picocuries per liter
psi	Pounds per square inch
S	Storativity
SDR	Standard Dimension Ratios
SFWMD	South Florida Water Management District
SR	State road
s.u.	Standard units
T	Transmissivity
TDS	Total dissolved solids
μg/L	Micrograms per liter
μmhos/cm	Micromhos per centimeter
USDW	Underground source of drinking water
USEPA	United States Environmental Protection Agency
USGS	United States Geological Survey

Section 1 Introduction and Scope

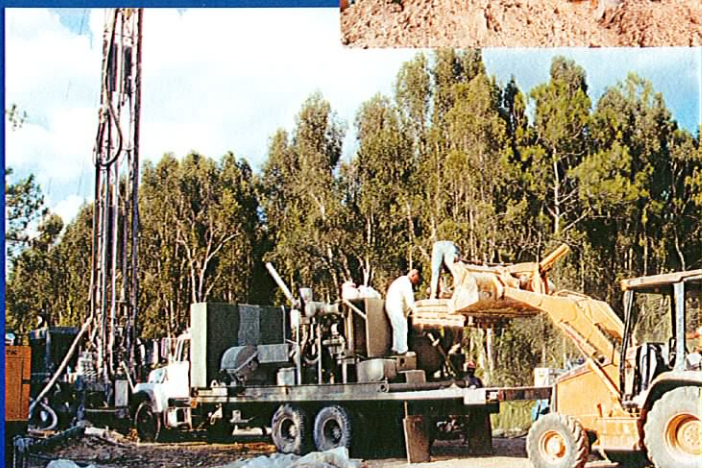

Introduction

1.1 Historical Background

The City of Fort Myers currently operates a surficial (very shallow \pm 30 feet deep) aquifer wellfield and a membrane softening water treatment plant (WTP). The surficial aquifer wellfield covers most of Section 21 and the northwest quarter of Section 28, Township 44 South, Range 25 East with a total area of 540 acres. It is located south of Dr. Martin Luther King, Jr. Boulevard (SR 82) and west of Ortiz Avenue. The WTP is located immediately west of the wellfield on the northeast corner of the intersection of Canal and Jacksonville Streets. A map showing the location of the wellfield and WTP is presented in Figure 1-1.

The surficial aquifer is artificially recharged with water being pumped by the city from the Caloosahatchee River upstream of the Olga lock. This was designed and built in the 1960s because of the limitations of the shallow aquifer. There are approximately 34 shallow wells in the wellfield with only about 20 wells that are active. The water quality from these wells is not compatible with the membrane WTP built years later. The water quality from the wells is directly related to the water quality of the Caloosahatchee River which has been deteriorating due to drought and other reasons beyond the scope of this report.

Because of problems from poor water quality and low production from the surficial aquifer wellfield, the City constructed two test deep production wells, P-1 and P-2, to evaluate the presence of an artesian water supply that would be compatible with the conversion of the existing WTP to reverse osmosis (RO). Details of the test production well construction and testing are documented in the CH2M HILL reports, *Engineering Report on the Construction and Testing of Artesian Test Production Well TP-1, Fort Myers, Florida, 1998* and *Engineering Report on the Construction and Testing of Artesian Production Well P-2, Fort Myers, Florida, 1999*.

Data obtained during the construction and testing of wells P-1 and P-2 confirmed that the intercepted artesian aquifer systems of the Lower Hawthorn producing zone of the intermediate aquifer and Upper Suwannee Limestone of the Floridan aquifer provide suitable water quality and productivity for the development of a brackish aquifer wellfield. Accordingly, the City has constructed five additional deep brackish aquifer production wells: P-3, P-4, P-5, P-6, and P-7. This report details the construction and testing of the new production wells and the installation of a 16-inch PVC liner in existing well P-1.

Construction and testing of the wells was performed in accordance with SFWMD construction permit nos. CON 24-06 SF050400A-E and the contract documents "*Construction and Testing of Five Artesian Aquifer Production Wells and Other Well Services for the City of Fort Myers Water Treatment Plant*," CH2M HILL, 2000. Copies of the SFWMD and Lee County Health Department Permits are provided in Appendix A.

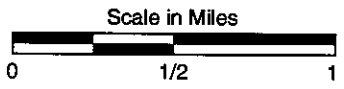
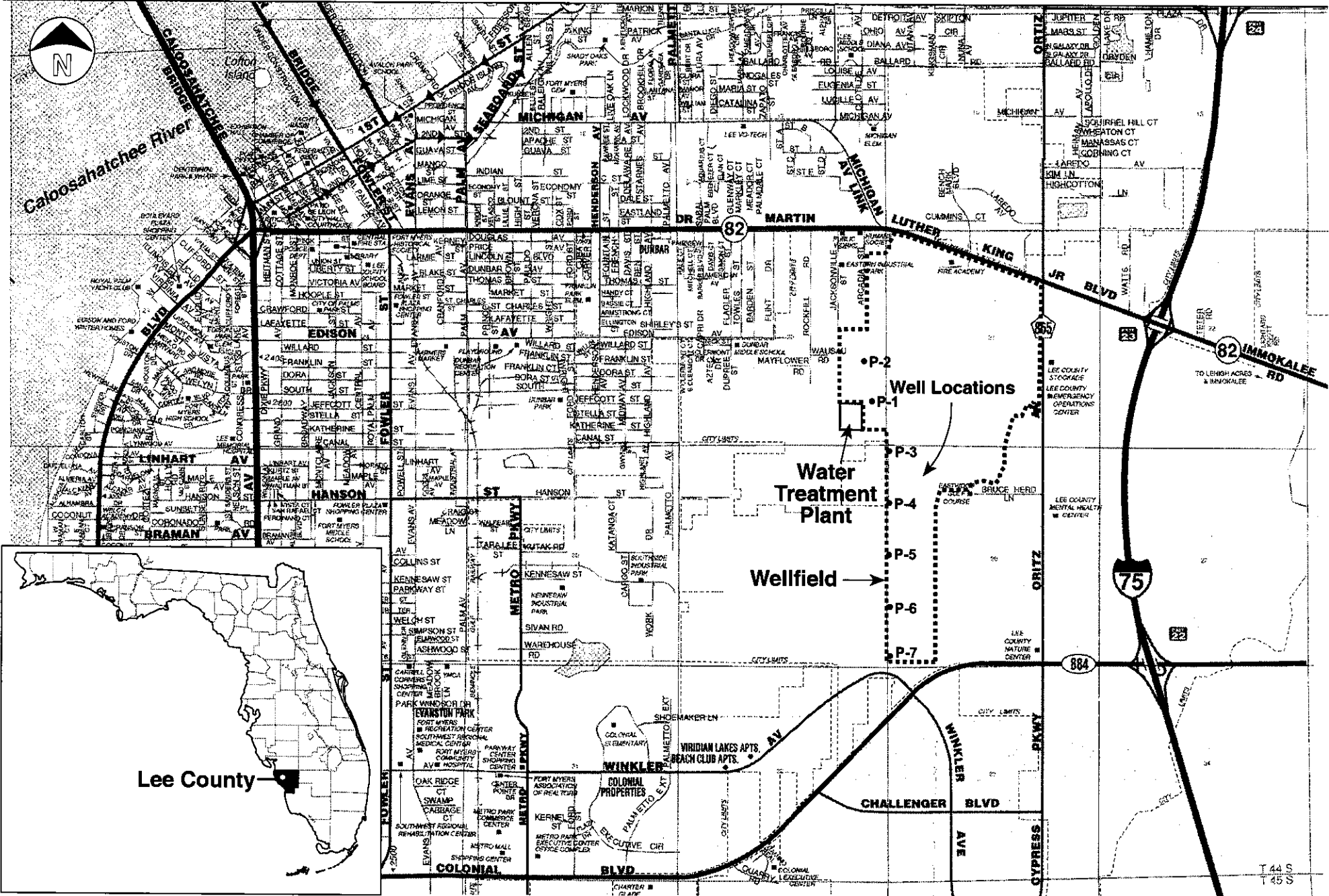

FIGURE 1-1
RO WTP Wellfield – Wells P1 to P7 Location Map

Section 2 Well Construction



SECTION 2

Well Construction

This section describes the modification of well P-1 and the construction of wells P-3 through P-7. Hydrogeologic testing and well acidizations are discussed in Sections 4 and 6, respectively.

For the construction of these wells, a pilot hole was drilled to the total depth of the well in two stages in order to collect pertinent information about the geology and hydrogeology of each site. Initially, the mud rotary drilling technique was used to drill through the surficial aquifer and the clay intervals that overlie the artesian aquifer. Once a depth for the surface casing is determined, the pilot hole was reamed out to a diameter that will accommodate the selected casing. Once the surface casing was cemented in place, a pilot hole was drilled using the reverse-air drilling technique to the depth of the final casing. After a depth for the final PVC casing was determined, the pilot hole was reamed out to a diameter that will accommodate the casing. After the final casing was cemented in place, a borehole slightly smaller than the inside diameter of the final casing was drilled using the reverse-air drilling technique to the total depth of each well, between 800 and 895 feet bls. The reverse-air drilling method allows for the removal of drill cuttings from the borehole, preliminary specific capacity testing of the aquifer, and the collection of pilot hole water samples at 30-foot intervals.

The drilling schedule and casing setting depths of the final wells were designed to conform to the hydrogeologic features observed during the drilling operations of the pilot hole at each site. Formation samples were collected at 10-foot intervals during the drilling of the pilot holes. Lithologic descriptions of the formation samples collected during construction of wells are presented in Appendix B. Data from the pilot hole formation samples (drill cuttings), water samples, air-lift specific capacity tests, and geophysical logs were evaluated to provide geologic and hydrogeologic information which were used to assist in the selection of the casing setting depths and the open hole intervals of the final wells. Tabulated summaries of construction and testing activities and a copy of the daily construction reports are presented in Appendices C and D, respectively. Copies of casing mill certificates for the casings and manufacturers data sheets for the PVC casing used during the construction of each well are presented in Appendix E.

2.1 Well P-1 Modification

Well P-1 was constructed in 1998 (at the time named test production well TP-1) with a 24-inch diameter steel final casing to 462 feet. The second production well, P-2, was constructed in 1999 and completed with 16-inch diameter SDR 17 PVC casing to 432 feet. The subsequent wells, P-3 through P-7 described below, were constructed similar to P-2. It was recommended to the City to modify well P-1 by relining the final casing from the 24-inch diameter steel to 16-inch diameter SDR 17 PVC casing. This relining will remove any potential of degradation of the steel casing and assure consistent water quality with the other wells in the wellfield.

A well construction diagram showing the before and after modification details of well P-1 is provided in Figure 2-1. The casing modification activity details conducted on well P-1 included:

- The well was backfilled with 1,189 ft³ of sand to a depth of 470 feet bls
- A 5-foot thick neat cement plug was placed on top of the sand
- The 16-inch diameter SDR 17 PVC casing was set at a depth of 464 feet bls
- The PVC casing was cemented in place with 480 bags of 4 percent bentonite grout
- The casing was tested for proper alignment using a 30-foot section of 12-inch diameter dummy casing was lowered in the well to a depth of 300 feet
- The cement plug and sand were removed from the well
- The well was then developed using a reverse-air technique from the bottom of the well to the bottom of the casing for a total of 5.5 hours
- A temporary pump was then replaced in the well at a depth of 80 feet bls (this well has been used to amend the water supply through blending)

2.2 Well P-3 Construction

Construction of well P-3 began on May 15, 2000 with the drilling installation of surface casing and ended on June 21, 2000, with the installation of a temporary wellhead. Construction of well P-3 included a 24-inch diameter steel surface casing and a 16-inch diameter SDR 17 PVC final casing. The casings serve to protect the fresh surficial aquifer from intrusion of relatively saline water from underlying aquifers and to preserve the integrity of confining beds.

The cementing program was specifically tailored for each casing installed. Table 2-1 provides a summary of the casing depths and the types and quantities of cement used during casing installation. A well construction details diagram of well P-3 is provided in Figure 2-2.

The drilling began by advancing an 8-inch diameter pilot hole by mud-rotary drilling to a depth of 100 feet bls. The pilot hole was then geophysically logged and reamed to a nominal 30-inch-diameter to a depth of 97 feet bls. After performing a caliper log on the reamed hole, a 24-inch diameter, 0.375-inch thick wall steel casing was then installed to a depth of 92 feet bls and its annular space between the borehole and outside of casing cemented back to land surface.

Following installation of the surface casing, an 8-inch diameter pilot hole was mud-rotary drilled to a depth of 552 feet bls and the open borehole was geophysically logged. Logs conducted include caliper, natural gamma ray, spontaneous potential, and dual induction. The pilot hole was reamed to a nominal 22.5-inch-diameter to a depth of 515 feet bls and geophysically logged. Immediately after logging, a 16-inch diameter PVC casing was installed to a depth of 510 feet bls and its annular space grouted to land surface.

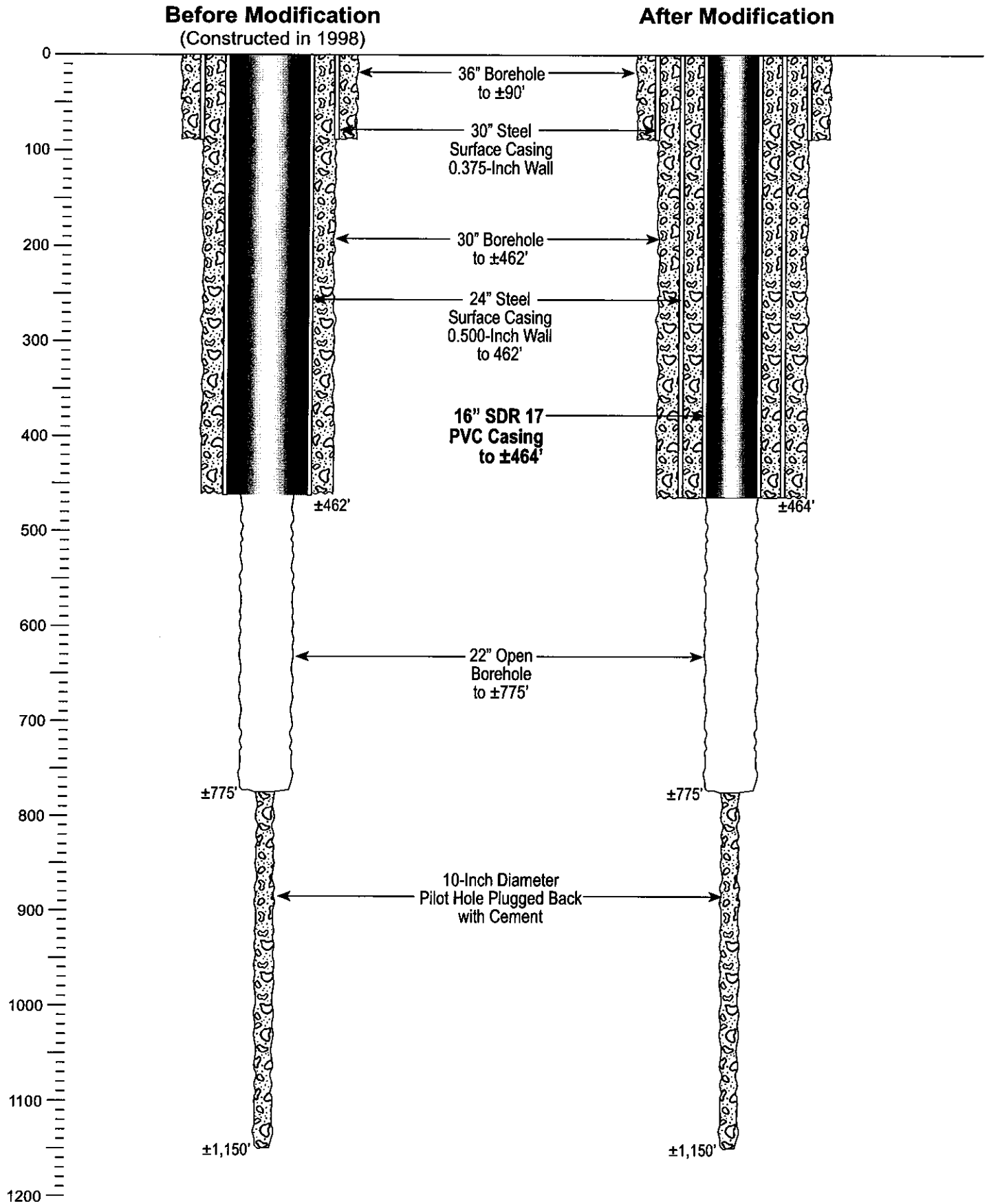

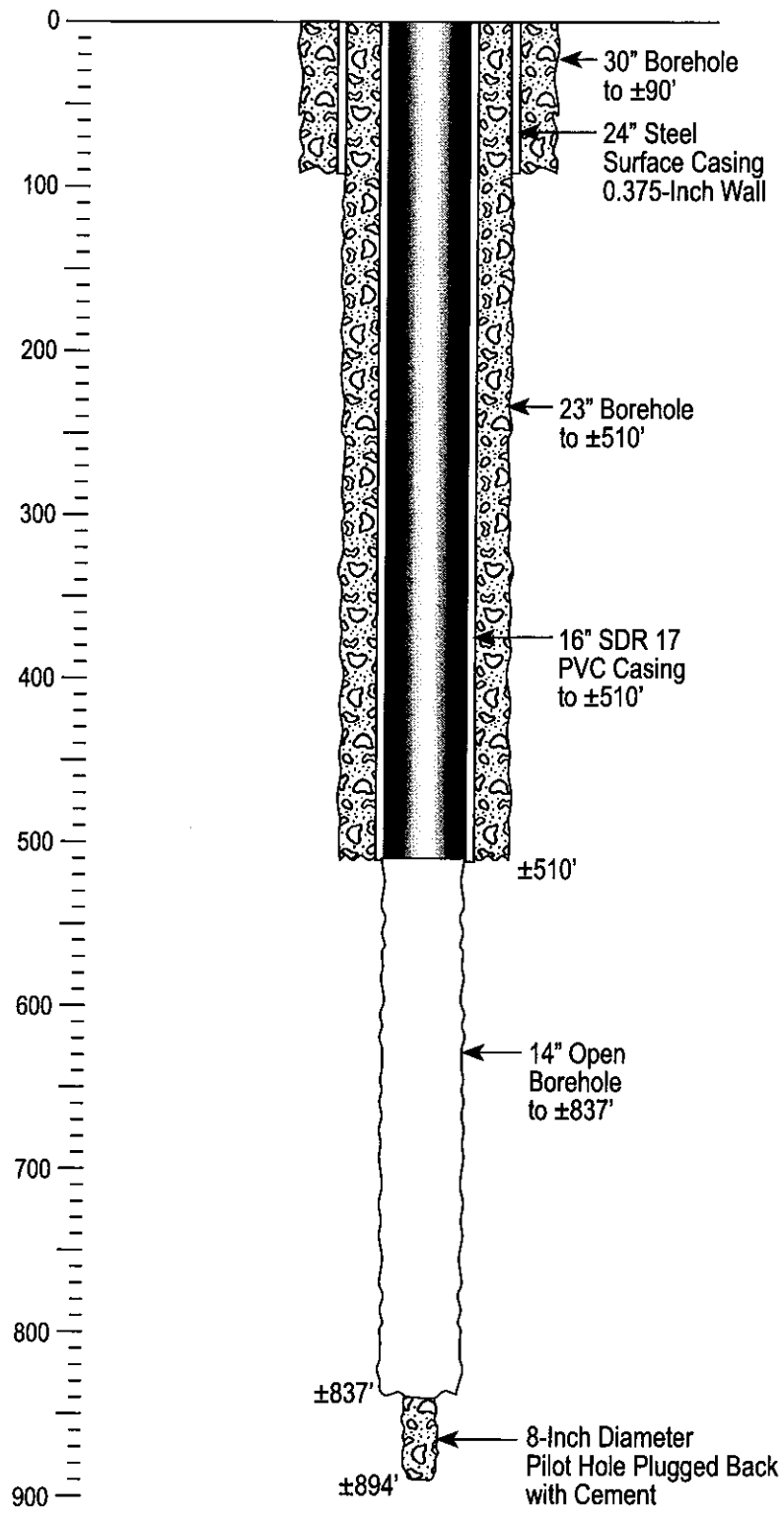

FIGURE 2-2
Well P-3 Construction Details

TABLE 2-1
 Summary of Casing Setting Depths and Cement Quantities; Production Well P-3
 City of Fort Myers WTP – Well Completion Report (P-3 through P-7)

Casing	Casing Material	Casing OD (inch)	Casing ID (inch)	Casing Thickness (inch)	Casing Depth (ft bls)	Date	Cement Stage	Type of Cement	Quantity of Cement (bags)
Surface	Steel	24.00	23.25	0.375	90	5/16/2000	#1	Neat	240
						Remarks: pressure grout from bottom of casing			
						5/17/2000	#2	6% bentonite	30
Remarks: tremied into annulus from 30 feet bls									
Final	PVC <i>(Certain-Teed SDR-17)</i>	16.00	14.20	0.900	510	5/25/2000	#1	Neat	160
						Remarks: pressure grout from bottom of casing			
						5/26/2000	#2	Neat	200
						Remarks: tremied into annulus from 235 feet bls			
						5/27/2000	#3	Neat	60
Remarks: tremied into annulus from 37 feet bls									
Total Sacks Neat:								660	
Total Sacks 6%:								30	

ft bls = feet below land surface

After final casing installation an 8-inch diameter pilot hole was reverse air drilled to a depth of 894 feet bls prior to conducting geophysical logging. Logs conducted under static conditions include caliper, natural gamma ray, spontaneous potential, dual induction, fluid temperature, fluid resistivity, and flowmeter. Fluid temperature, fluid resistivity, and flowmeter logs were also conducted under dynamic (pumping at 520 gpm) conditions. Air-lift specific capacity tests were conducted during pilot hole drilling at approximately 30-foot intervals and pilot hole water samples were collected in 30-foot intervals during all reverse-air pilot hole drilling. The data were used to allow a field evaluation of well productivity and water quality.

Following geophysical logging of the open borehole, a single packer was installed at 820 feet bls and a test was conducted by pumping the open bore hole zone below the packer, at a rate of 8 gpm.

Following completion of geophysical logging and packer tests, the pilot hole was backplugged with 25 bags of neat cement to a depth of 837 feet bls. The interval from 510 to 837 feet bls was reamed with reverse-air to a nominal 14-inch diameter, prior to beginning development of the well. The first stage of the well development was accomplished using reverse-air development through the bit. The final geophysical logging was conducted on June 21, 2000 and included color video, caliper, and natural gamma ray.

The well was closed in with an acidization header with one 1-inch port and one 3-inch gate valve, and one valved 1-inch port. Further well development was completed following acidization of the well (see Section 6).

After the well was completed, a temporary wellhead was built and installed. This wellhead is installed on all of the wells after completion. A general wellhead construction schematic is provided in Figure 2-3.

2.3 Well P-4 Construction

Construction of well P-4 began on May 15, 2000 and ended on June 21, 2000, with the installation of a temporary wellhead. A summary of construction and testing activities and a copy of the daily construction reports are presented in Appendices C and D, respectively.

Well P-4 was completed with a 24-inch-diameter steel surface casing and a 16-inch-diameter SDR 17 PVC final casing. The surface casing was installed to protect the fresh surficial aquifer from intrusion of higher salinity water from underlying aquifers. The PVC casing serves to preserve the integrity of confining beds. Table 2-2 provides a summary of the casing depths and the types and quantities of cement used during casing installation. A completion diagram of well P-4 is provided in Figure 2-4.

TABLE 2-2

Summary of Casing Setting Depths and Cement Quantities; Production Well P-4
City of Fort Myers WTP – Well Completion Report (P-3 through P-7)

Casing	Casing Material	Casing OD (inch)	Casing ID (inch)	Casing Thickness (inch)	Casing Depth (ft bls)	Date	Cement Stage	Type of Cement	Quantity of Cement (bags)
Surface	Steel	24.00	23.25	0.375	90	5/16/2000	#1	Neat	240
						Remarks pressure grout from bottom of casing			
						5/17/2000	#2	6% bentonite	10
Remarks tremied into annulus from 11 feet bls									
Final	PVC (Certain-Teed SDR-17)	16.00	14.20	0.900	510	6/1/2000	#1	4% bentonite	120
						Remarks pressure grout from bottom of casing			
						6/1/2000	#1	Neat	80
						Remarks continue pressure grout from bottom of casing switching to neat cement			
						6/2/2000	#2	4% bentonite	180
Remarks tremied into annulus from 195 feet bls									
Remarks									
Remarks tremied into annulus from 32 feet bls									
Total Sacks Neat:								320	
Total Sacks 4%:								300	
Total Sacks 6%:								10	

ft bls = feet below land surface

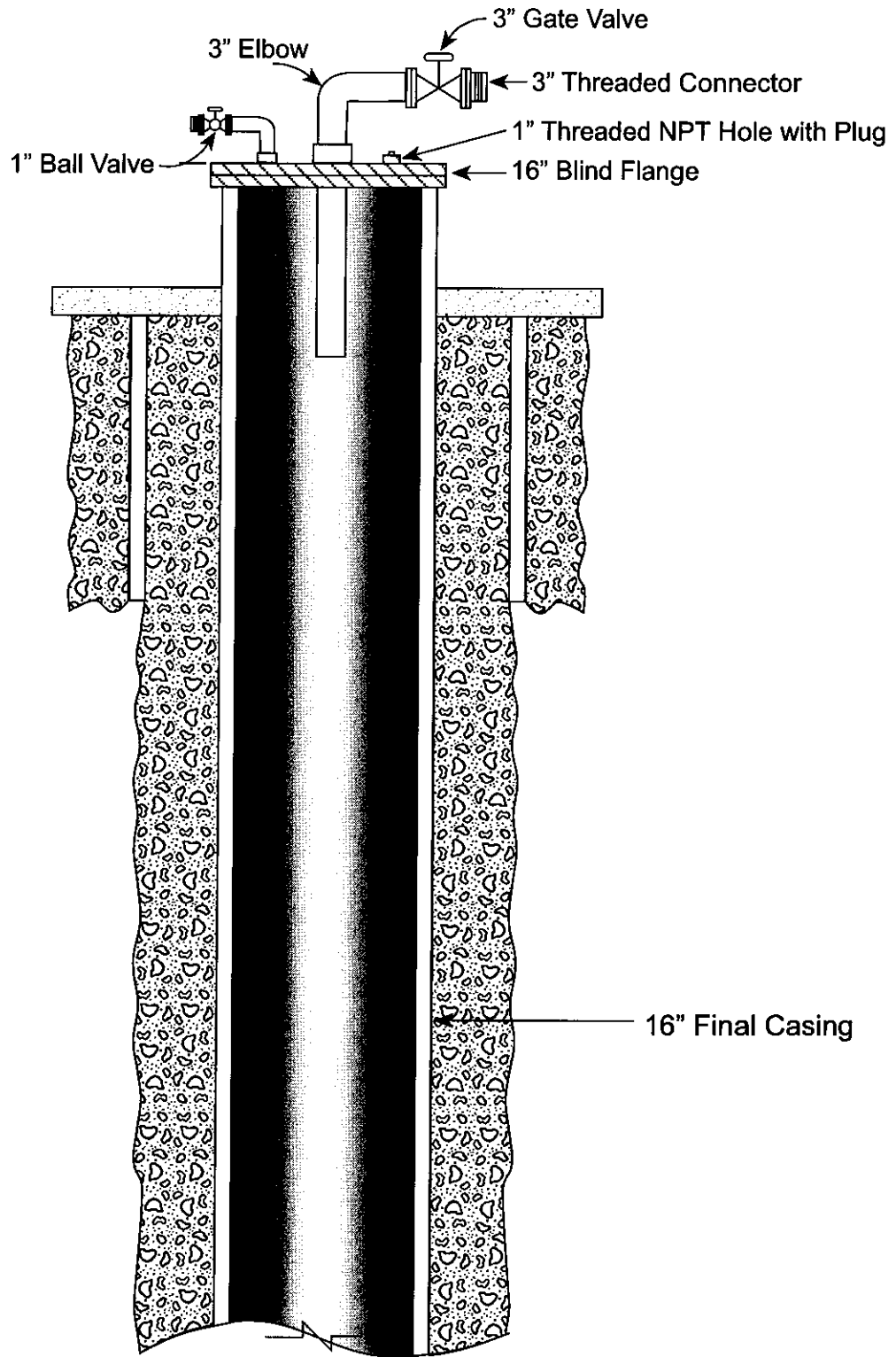

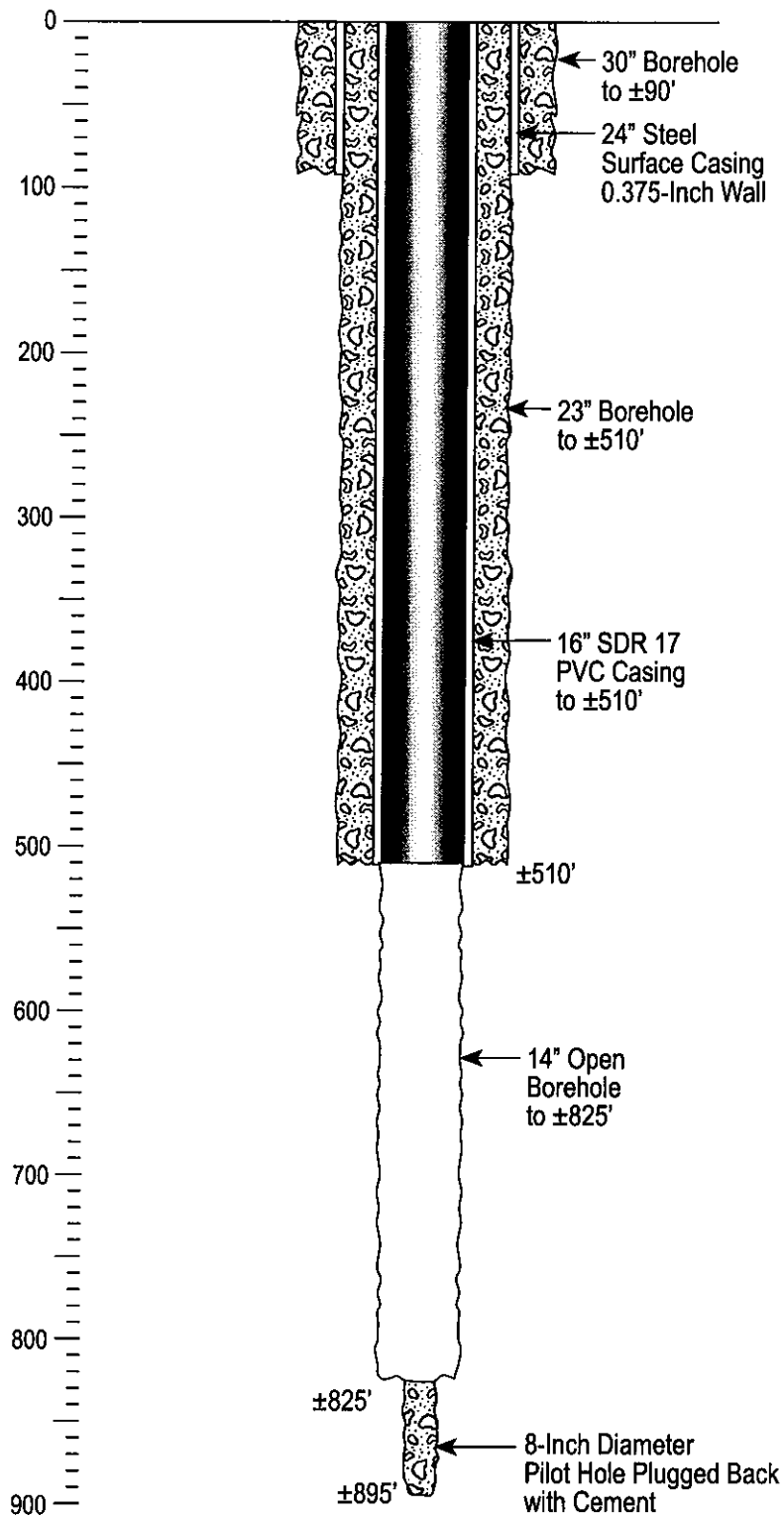

FIGURE 2-4
Well P-4 Construction Details

The drilling began with an 8-inch diameter pilot hole drilled with mud-rotary to a depth of 100 feet bls. The pilot hole was then geophysically logged and reamed to a nominal 30-inch-diameter to a depth of 94 feet bls. A caliper log was then run to verify the diameter of the reamed hole. A 24-inch diameter, 0.375-inch thick wall steel casing was then installed to a depth of 90 feet bls and the casing annular space was cemented back to land surface.

The 8-inch diameter pilot hole was then advanced by mud-rotary drilling to a depth of 562 feet bls. The pilot hole was logged with caliper, natural gamma ray, spontaneous potential, and dual induction logs to determine the final casing depth. The pilot hole was then reamed to a nominal 22.5-inch-diameter to a depth of 515 feet bls and a drillable bridge plug was installed from 515 feet to 520 feet bls. A caliper log was run on the final hole and the 16-inch diameter PVC casing was installed to a depth of 510 feet bls and its annular space grouted back to land surface.

The pilot hole was drilled to a final depth of 895 feet bls by reverse air. Air-lift specific capacity testing was conducted and water samples were collected at approximately 30-foot intervals during all reverse-air pilot hole drilling. Full suites of geophysical logs were conducted under static and dynamic conditions including: caliper, natural gamma ray, spontaneous potential, dual induction, fluid temperature, fluid resistivity, and flowmeter. Fluid temperature, fluid resistivity, and flowmeter logs were also conducted under dynamic (pumping at 630 gpm) conditions.

Following completion of geophysical logging, the pilot hole was backplugged with 20 bags of neat cement to a depth of 825 feet bls. The production interval from 510 to 825 feet bls was reamed with reverse-air drilling to a nominal 14-inch diameter.

Well development was accomplished using reverse-air development through the bit and by over pumping and surging of the well. The final geophysical logging was conducted on June 21, 2000 and included color video, caliper, and natural gamma ray.

The well was closed with an acidization header with one 1-inch port and one 3-inch gate valve, and one valved 1-inch port. Further well development was completed following acidization of the well (see Section 6). A completion diagram of the temporary wellhead that was installed after the well was completed is presented previously in Figure 2-3.

2.4 Well P-5 Construction

Construction of well P-5 began on July 3, 2000 and ended on August 2, 2000, with the installation of a temporary wellhead. Well P-5 was constructed with two concentric casings, a 24-inch diameter steel casing and a 16-inch diameter PVC casing. Table 2-3 provides a summary of the casing depths and the types and quantities of cement used during casing installation. A completion diagram of well P-5 is provided in Figure 2-5.

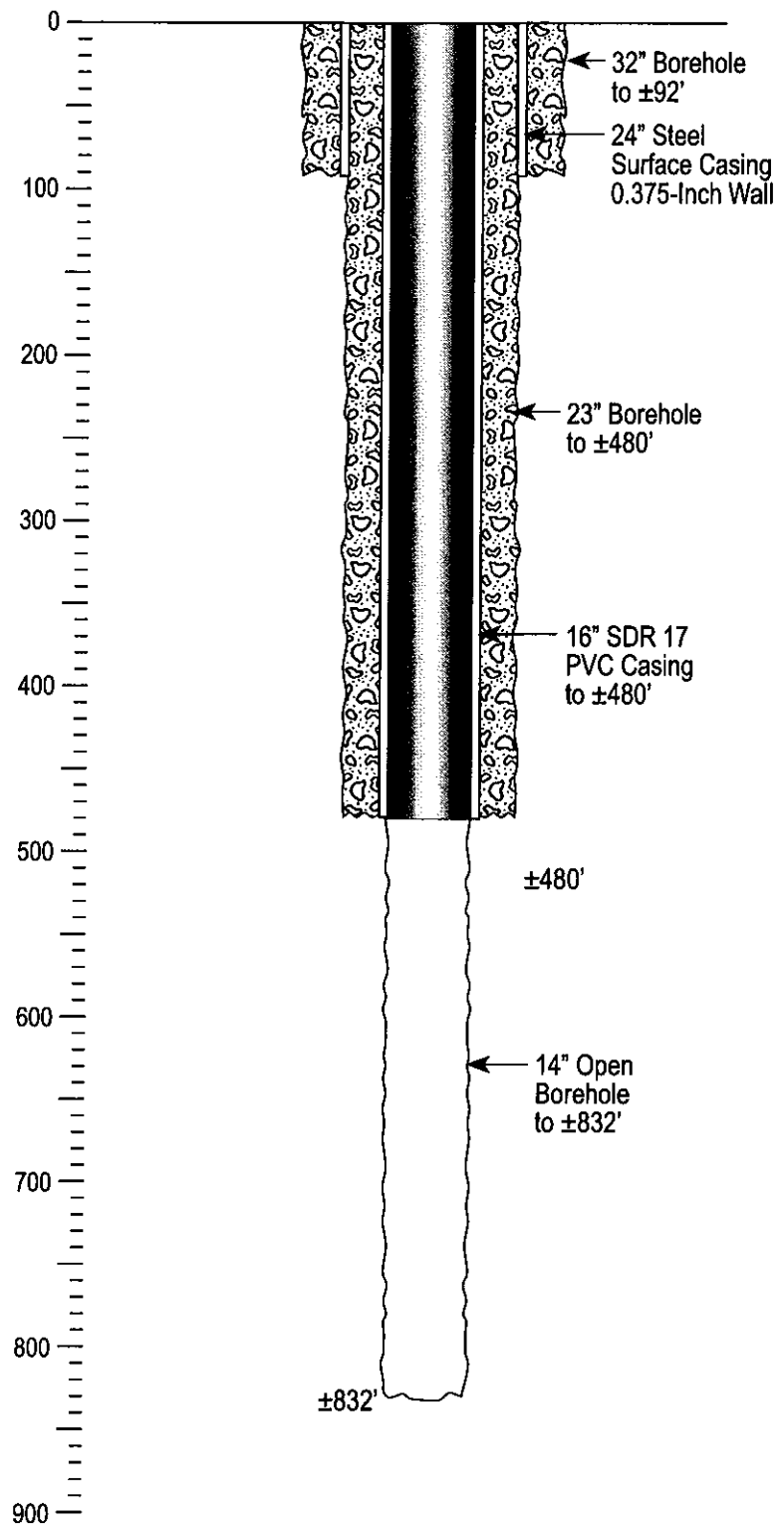

FIGURE 2-5
Well P-5 Construction Details

TABLE 2-3
 Summary of Casing Setting Depths and Cement Quantities; Production Well P-5
 City of Fort Myers WTP – Well Completion Report (P-3 through P-7)

Casing	Casing Material	Casing OD (inch)	Casing ID (inch)	Casing Thickness (inch)	Casing Depth (ft bls)	Date	Cement Stage	Type of Cement	Quantity of Cement (bags)					
Surface	Steel	24.00	23.25	0.375	92	7/6/2000	#1	4% bentonite	210					
						Remarks pressure grout from bottom of casing				7/7/2000	#2	4% bentonite	120	
						Remarks tremied into annulus from 21 feet bls				7/7/2000	#3	Neat	20	
Remarks tremied into annulus from 10 feet bls														
Final	PVC (Certain-Teed SDR-17)	16.00	14.20	0.900	480	7/18/2000	#1	4% bentonite	120					
						Remarks pressure grout from bottom of casing				7/18/2000	#1	Neat	84	
						Remarks continue pressure grout from bottom of casing switching to neat cement				7/19/2000	#2	4% bentonite	180	
						Remarks tremied into annulus from 335 feet bls				7/20/2000	#3	4% bentonite	180	
						Remarks tremied into annulus from 146 feet bls								
										Total Sacks Neat:		104		
				Total Sacks 4%:		810								

ft bls = feet below land surface

An 8-inch diameter pilot hole was first drilled by mud-rotary to a depth of 110 feet bls. Caliper and gamma ray logs were run and then the hole was reamed to a nominal 32-inch-diameter to a depth of 97 feet bls. After performing a caliper log on the reamed hole, a 24-inch diameter, 0.375-inch thick wall steel casing was then installed to a depth of 92 feet bls and its annular space between the borehole and outside of casing grouted back to land surface.

After the surface casing was installed, an 8-inch diameter pilot hole was mud-rotary drilled to a depth of 523 feet bls and geophysically logged. Logs conducted on the pilot hole included caliper, natural gamma ray, spontaneous potential, and dual induction. The pilot hole was reamed to a nominal 24-inch diameter to a depth of 485 feet bls. Immediately after caliper and gamma ray logs were run, a 16-inch diameter PVC casing was installed to a depth of 480 feet bls and its annular space grouted back to land surface.

Using the reverse-air drilling method, an 8-inch diameter pilot hole was then advanced to a depth of 832 feet bls. Air-lift specific capacity tests were conducted at approximately 30-foot intervals and pilot hole water samples were collected in 30-foot intervals during all reverse-air pilot hole drilling. Logs conducted under static conditions include caliper, natural gamma ray, spontaneous potential, dual induction, fluid temperature, fluid resistivity, and flowmeter. Fluid temperature, fluid resistivity, and flowmeter logs were also conducted under dynamic (pumping at 655 gpm) conditions. The data were used to allow a field evaluation of well productivity and water quality.

Following geophysical logging, the borehole was reamed with reverse-air to a nominal 14-inch diameter. The first stage of the well development was accomplished using reverse-air development through the bit. The final geophysical logging was conducted on August 2, 2000 and included color video, caliper, and natural gamma ray.

The well was closed with an acidization header with one 1-inch port and one 3-inch gate valve, and one valved 1-inch port. Further well development was completed following acidization of the well (see Section 6). A completion diagram of the temporary wellhead that was installed after the well was completed is presented previously in Figure 2-3.

2.5 Well P-6 Construction

Construction of well P-6 began on August 10, 2000 and ended on September 19, 2000, with the installation of a temporary wellhead. Construction of well P-6 included two concentric casings, a 26-inch diameter steel casing and a 16-inch diameter PVC casing. Table 2-4 provides a summary of the casing depths and the types and quantities of cement used during casing installation. A completion diagram of well P-6 is provided in Figure 2-6.

Construction of well P-6 began with an 8-inch diameter pilot hole drilled by mud-rotary to a depth of 92 feet bls. Following geophysical logging, the pilot hole was reamed to a nominal 32-inch-diameter. After performing a caliper log on the reamed hole, a 26-inch diameter, 0.375-inch thick wall steel casing was then installed to a depth of 92 feet bls and its annular space between the borehole and outside of the casing grouted to land surface.

Following installation of the surface casing, an 8-inch diameter pilot hole was mud-rotary drilled to a depth of 561 feet bls. Geophysical logging performed on the hole included: caliper, natural gamma ray, spontaneous potential, and dual induction. The pilot hole was reamed to a nominal 24-inch-diameter to 450 feet bls. After a caliper and gamma ray log were run to confirm the reamed hole characteristics, a 16-inch diameter PVC casing was installed to a depth of 445 feet bls and its annular space grouted to land surface.

Following final casing installation, an 8-inch diameter pilot hole was then reverse air drilled to a depth of 805 feet bls. Air-lift specific capacity tests were conducted at approximately 30-foot intervals and pilot hole water samples were collected at 30-foot intervals during all reverse-air pilot hole drilling. Geophysical logging was conducted under static and dynamic conditions and included: caliper, natural gamma ray, spontaneous potential, dual induction, fluid temperature, fluid resistivity, and flowmeter. Fluid temperature, fluid resistivity, and flowmeter logs were also conducted under dynamic (pumping at 823 gpm) conditions.

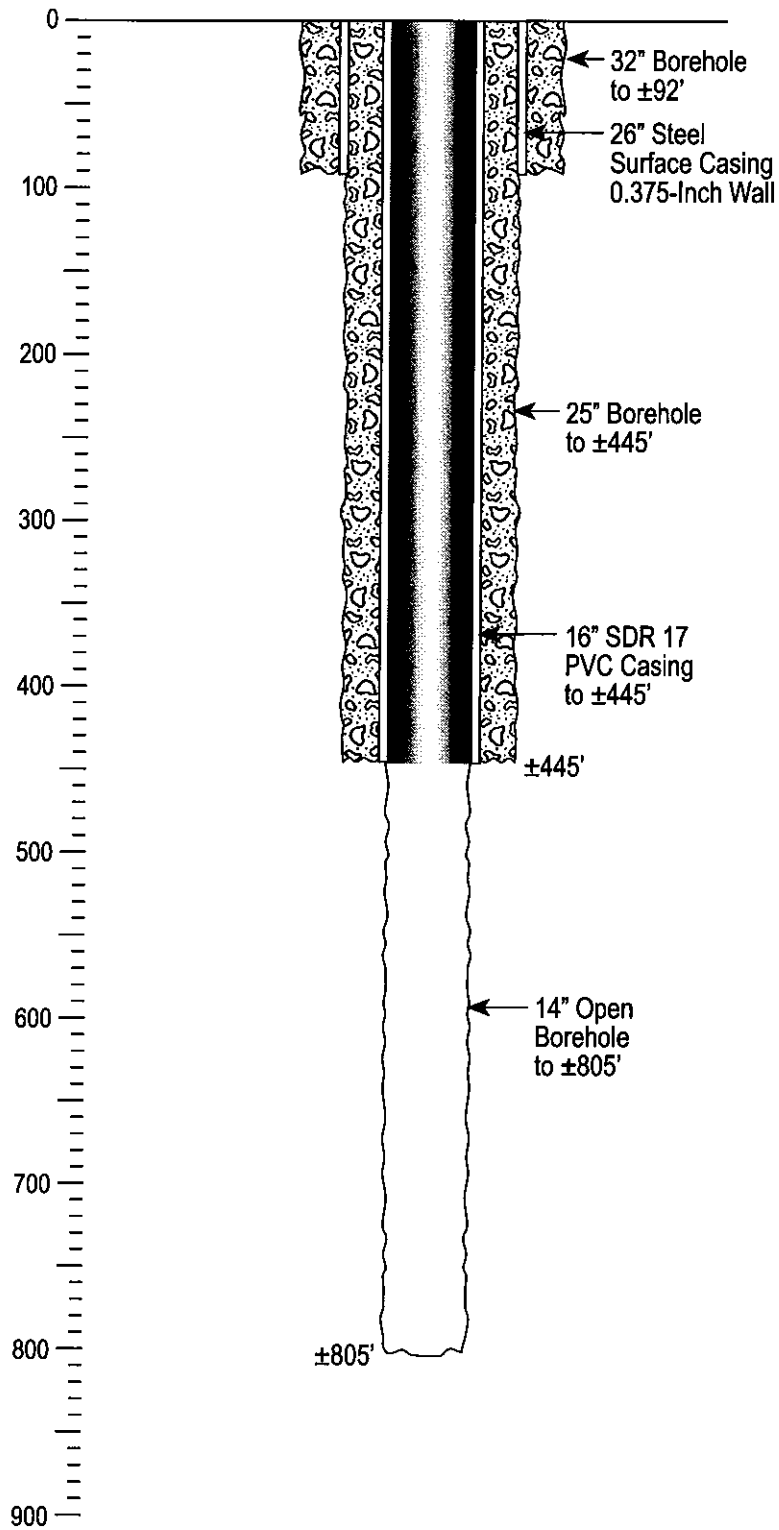

TABLE 2-4
 Summary of Casing Setting Depths and Cement Quantities; Production Well P-6
 City of Fort Myers WTP – Well Completion Report (P-3 through P-7)

Casing	Casing Material	Casing OD (inch)	Casing ID (inch)	Casing Thickness (inch)	Casing Depth (ft bls)	Date	Cement Stage	Type of Cement	Quantity of Cement (bags)
Surface	Steel	26.00	25.25	0.375	85	8/16/2000	#1	Neat	120
						Remarks	pressure grout from bottom of casing		
						8/16/2000	#1	4% bentonite	120
						Remarks	continue pressure grout from bottom of casing switching to neat cement		
						8/17/2000	#2	6% bentonite	240
						Remarks	tremied into annulus from 40 feet bls		
Final	PVC (Certain-Teed SDR-17)	16.00	14.20	0.900	445	9/5/2000	#1	4% bentonite	90
						Remarks	pressure grout from bottom of casing		
						9/5/2000	#1	Neat	159
						Remarks	pressure grout from bottom of casing		
						9/6/2000	#2	4% bentonite	210
						Remarks	tremied into annulus from 280 feet bls		
						9/7/2000	#3	4% bentonite	150
						Remarks	tremied into annulus from 96 feet bls		
							Total Sacks Neat:		159
							Total Sacks 4%:		450

ft bls = feet below land surface

The borehole was reamed with reverse-air drilling to a nominal 14-inch diameter prior to beginning development of the well. The first stage of the well development was accomplished using reverse-air development through the bit. The final geophysical logging was conducted on September 19, 2000 and included color video, caliper, and natural gamma ray.

The well was closed with an acidization header with one 1-inch port and one 3-inch gate valve, and one valved 1-inch port. Further well development was completed following acidization of the well (see Section 6). A completion diagram of the temporary wellhead that was installed after the well was completed is presented previously in Figure 2-3.

2.6 Well P-7 Construction

Construction of well P-7 began on July 7, 2000 and ended on August 23, 2000, with the installation of a temporary wellhead. A summary of construction and testing activities and a copy of the daily construction reports are presented in Appendices C and D, respectively.

Construction of well P-7 included two concentric casings, a 26-inch diameter steel casing and a 16-inch diameter PVC casing. Table 2-5 provides a summary of the casing depths and the types and quantities of cement used during casing installation. A completion diagram of well P-7 is provided in Figure 2-7.

TABLE 2-5
Summary of Casing Setting Depths and Cement Quantities; Production Well P-7
City of Fort Myers WTP – Well Completion Report (P-3 through P-7)

Casing	Casing Material	Casing OD (inch)	Casing ID (inch)	Casing Thickness (inch)	Casing Depth (ft bls)	Date	Cement Stage	Type of Cement	Quantity of Cement (bags)
Surface	Steel	26.00	25.25	0.375	75	7/20/2000	#1	Neat	120
						Remarks pressure grout from bottom of casing			
						7/20/2000	#1	4% bentonite	60
						Remarks continue pressure grout from bottom of casing switching to neat cement			
						7/28/2000	#2	4% bentonite	22
						Remarks tremied into annulus from 15 feet bls			
Final	PVC (Certain-Teed SDR-17)	16.00	14.20	0.900	445	8/3/2000	#1	4% bentonite	90
						Remarks pressure grout from bottom of casing			
						8/3/2000	#1	Neat	131
						Remarks continue pressure grout from bottom of casing switch to neat cement			
						8/4/2000	#2	4% bentonite	198
						Remarks tremied into annulus from 210 feet bls			
						8/5/2000	#3	4% bentonite	124
						Remarks tremied into annulus from 84 feet bls			
						8/7/2000	#4	4% bentonite	35
						Remarks tremied into annulus from 22 feet bls			
Total Sacks Neat:								251	
Total Sacks 4%:								529	

ft bls = feet below land surface

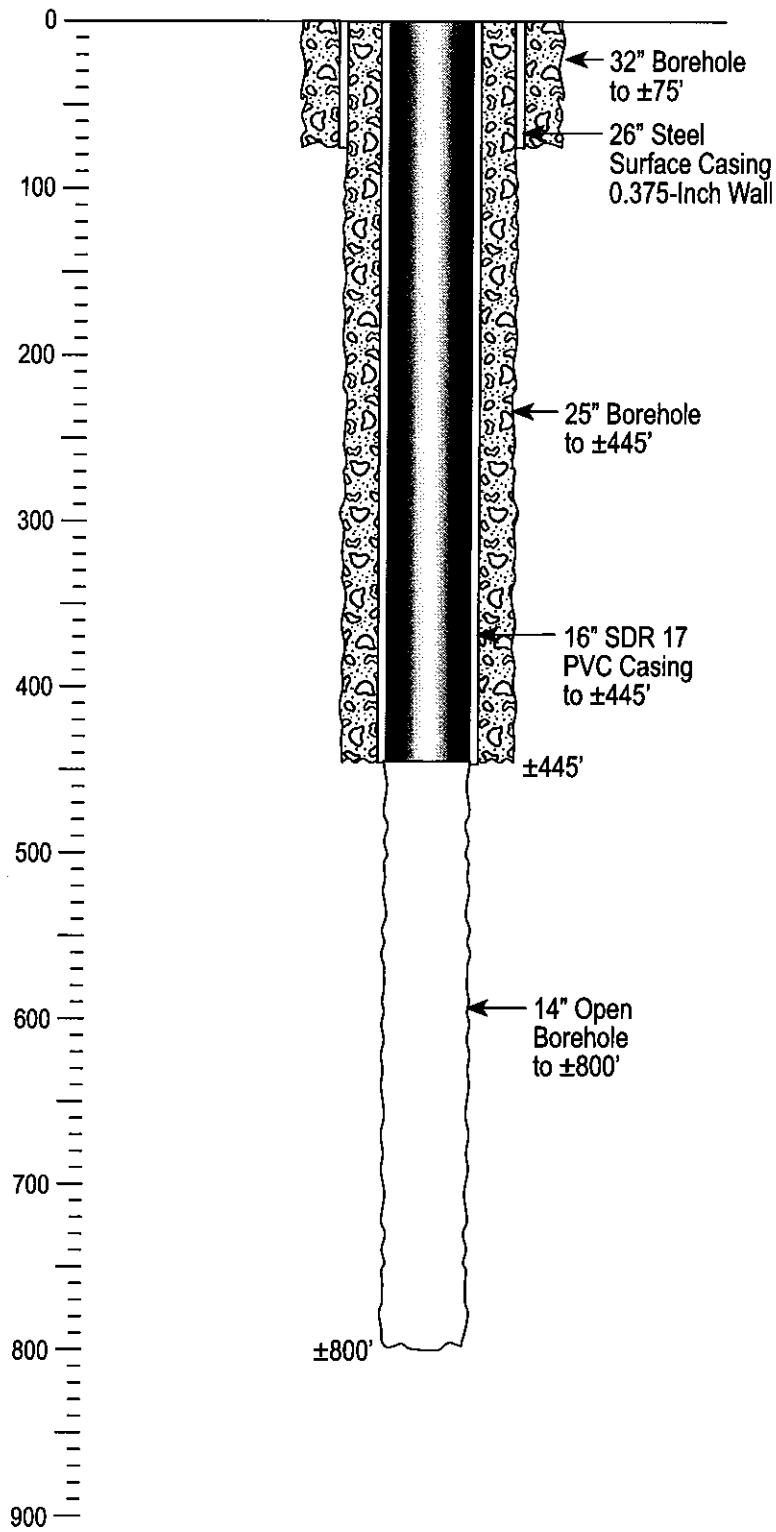

Well P-7 construction began by drilling an 8-inch diameter pilot hole by mud-rotary to a depth of 110 feet bls. The pilot hole was then geophysically logged and reamed to a nominal 32-inch-diameter to a depth of 97 feet bls. After performing a caliper log on the reamed hole, a 26-inch diameter, 0.375-inch thick wall steel casing was then installed to a depth of 75 feet bls and its annular space grouted to land surface.

Following installation of the surface casing, an 8-inch diameter pilot hole was mud-rotary drilled to a depth of 470 feet bls and then geophysically logged. Logs conducted include caliper, natural gamma ray, spontaneous potential, and dual induction. The pilot hole was reamed to a nominal 24-inch diameter to a depth of 450 feet bls and then logged again with caliper and gamma ray logs. Immediately after logging, a 16-inch diameter PVC casing was installed to a depth of 445 feet bls and its annular space grouted to land surface.

After installation of the final casing, an 8-inch diameter pilot hole was reverse air drilled to a depth of 800 feet bls and the hole geophysically logged. Air-lift specific capacity tests were conducted at approximately 30-foot intervals and pilot hole water samples were collected at 30-foot intervals during all reverse-air pilot hole drilling. Logs conducted under static conditions include caliper, natural gamma ray, spontaneous potential, dual induction, fluid temperature, fluid resistivity, and flowmeter. Fluid temperature, fluid resistivity, and flowmeter logs were also conducted under dynamic (pumping at 655 gpm) conditions.

The borehole was reamed to a nominal 14-inch diameter prior to beginning development of the well. The first stage of the well development was accomplished using reverse-air development through the bit. The final geophysical logging was conducted on August 23, 2000 and included color video, caliper, and natural gamma ray.

The well was closed with an acidization header with one 1-inch port and one 3-inch gate valve, and one valved 1-inch port. Further well development was completed following acidization of the well (see Section 6). A completion diagram of the temporary wellhead that was installed after the well was completed is presented previously in Figure 2-3.

Section 3 Geology and Hydrogeology



Geology and Hydrogeology

Groundwater in Lee County's aquifer systems are developed within a thick carbonate platform which overlies the Early Jurassic (150 to 195 million years old) basement rocks. Sediments within the carbonate platform range in age from Early Jurassic to Recent. The sediments consist primarily of carbonates and Miocene age siliciclastics. The aquifer systems in Lee County are contained within sediments ranging in age from late Paleocene (55 million years old) to Holocene (recent) and include the Floridan Aquifer System, the Intermediate Aquifer System, and the Surficial Aquifer System.

3.1 Fort Myers Artesian Aquifer Wellfield

In general, groundwater at the Fort Myers wellfield becomes more mineralized with depth. Potable groundwater is found only in limited quantities within the surficial aquifer and the very upper portions of the Intermediate Aquifer.

The drilling and testing of wells P-1 and P-2 confirmed the existence of a highly productive brackish water aquifer within the carbonate units in the Lower Hawthorn Producing Zone and the upper portion of the Suwannee Limestone. Based on testing and geophysical logs, the production intervals of this system ranged from approximately 430 feet bls to approximately 800 feet bls. All new wells (P-3 through P-7) were completed with an open borehole that intercepts this interval.

A brief description of the geologic and hydrogeologic units encountered during construction is provided below.

3.2 Lithostratigraphic Descriptions

Sediments encountered during the construction of production wells P-3 through P-7 range in age from Oligocene to Holocene. A brief discussion of Holocene to Oligocene age sediments and their relationship to the hydrostratigraphy of the site follows. Figure 3-1 provides the location of geologic cross section of the site. Figure 3-2 provides the geologic cross section A-A' across the site. The hydrostratigraphic nomenclature utilized in Figure 3-2 and discussed below is based on SFWMD Technical Publication 84-10.

3.3 Undifferentiated Holocene and Pleistocene Series

Quartz sand, shell beds, clay, and limestone of varying thickness make up the surficial undifferentiated Holocene and Pleistocene sediments in Lee County. The lower boundary of the undifferentiated deposits at the site are ranges from approximately 13 feet bls to 5 feet bls. The undifferentiated Holocene and Pleistocene deposits comprise the water table portion of the Surficial Aquifer at the site.

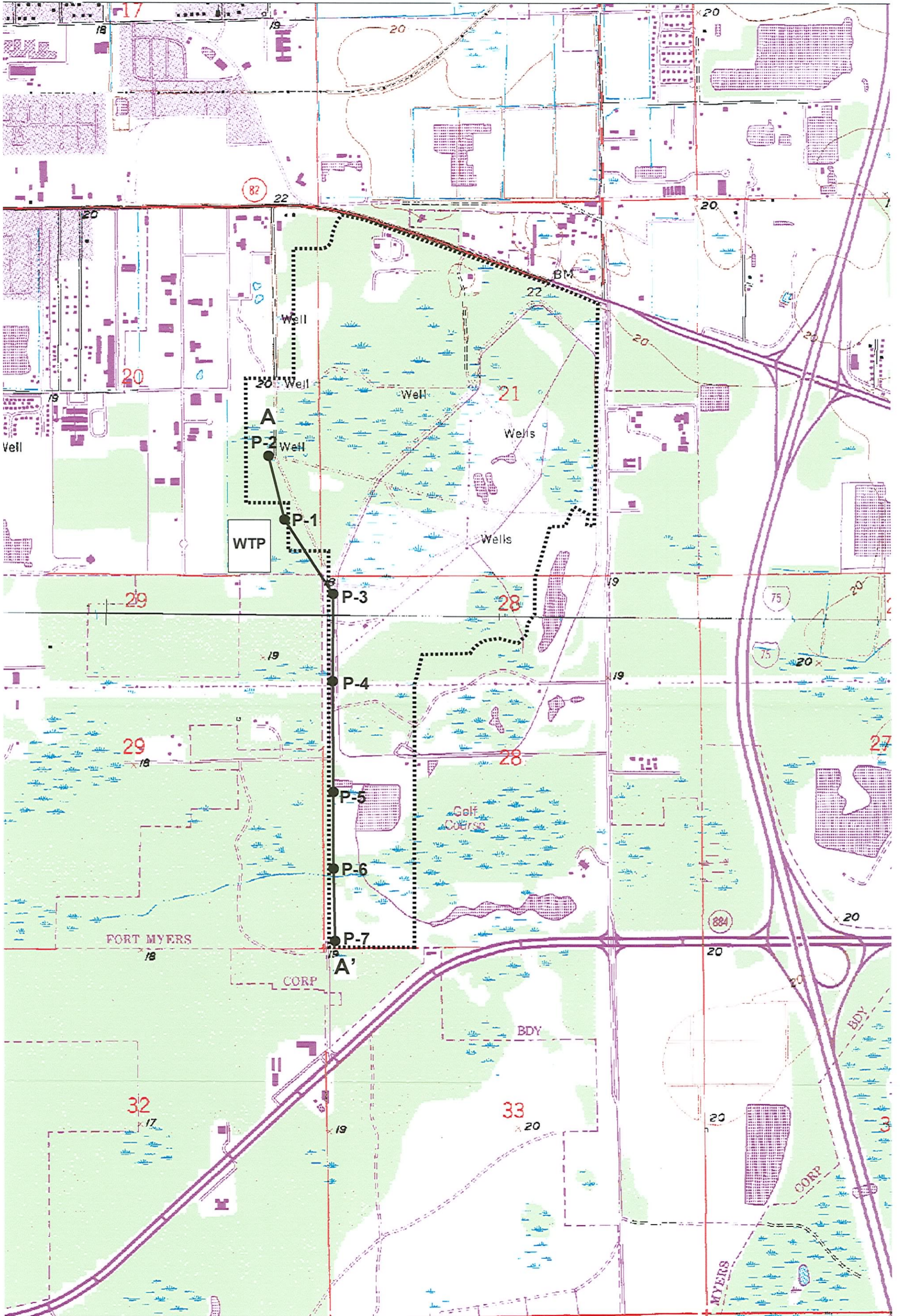

USGS Quads:
Fort Myers SE, FL - 1987
Fort Myers SW, FL - 1987

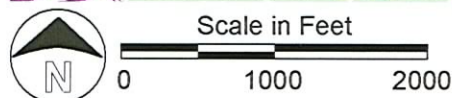

FIGURE 3-1
Location of Geologic Cross Section A-A'

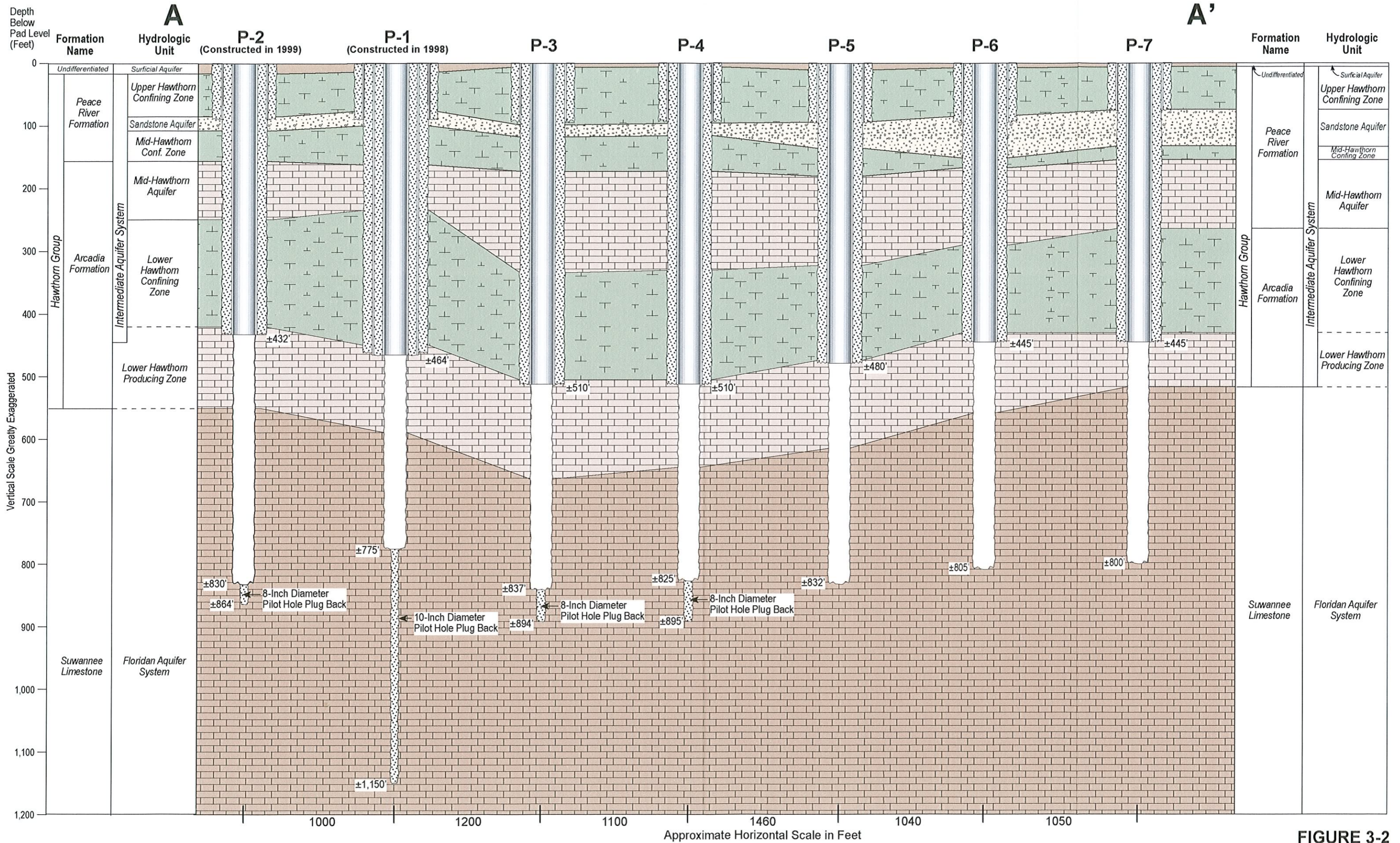

FIGURE 3-2
Geologic Cross Section A-A' and
General Well Construction

3.3.1 Pliocene Series

Tamiami Formation. The Tamiami Formation underlies most of Lee County. It varies in thickness from less than 10 feet to more than 100 feet, thickening to the south. Where present, the base of the Tamiami Formation forms the base of the Surficial Aquifer in Lee County. The Tamiami Formation was not encountered at any of the well sites.

3.3.2 Miocene Series

Hawthorn Group. In Lee County, the Hawthorn Group is divided into two members. The upper member is the Peace River Formation, which is made up primarily of olive gray and phosphatic clay with interbedded sandy limestone at the site. The lower member is a predominantly carbonate formation consisting of limestone and phosphatic limestone with interbedded phosphatic clay. The lower member of the Hawthorn Group is the Arcadia Formation. Aquifers within the Hawthorn Group are collectively referred to as the Intermediate Aquifer System.

The top of the Peace River Formation was encountered between depths of 5 feet bls and 13 feet bls and is approximately 75 feet thick at the site. The top of the Peace River Formation is a low permeability unit that acts as a confining interval (upper Hawthorn Confining Zone) separating the surficial aquifer from the Sandstone Aquifer. The Sandstone Aquifer consists of moderately porous sandy limestone and the top of the unit is found between 74 and approximately 96 feet bls at the site. The Sandstone Aquifer generally thickens to the south and ranges from 20 feet thick at well P-3 to 58 feet thick at well P-7. The Mid-Hawthorn Confining Zone is present below the Sandstone Aquifer and consists of low permeability olive gray clay with a trace of phosphate. The top of the Mid-Hawthorn Confining Zone was found between 114 feet bls and 142 feet bls and the unit ranges in thickness from approximately 55 feet thick near well P-3 to approximately 25 feet thick near well P-7.

The lower lithologic unit of the Hawthorn Group, the Arcadia Formation, consists primarily of interbedded phosphatic limestone, clay, and fine-grained limestone at the site. The top of the Arcadia Formation was encountered between 155 feet bls and 178 feet bls. The Arcadia Formation ranges from 494 feet thick near well P-3 to 363 feet thick at well P-7 and is characterized by a moderate to high gamma ray signature (30 to 200 API units). The Mid-Hawthorn Aquifer consists primarily of limestone with interbedded clay and ranges from 166 feet thick to 110 feet thick at wells P-3 to P-7, respectively. The lower Hawthorn Confining Zone separates the Mid-Hawthorn Aquifer from the lower Hawthorn Producing Zone and ranges in thickness from 224 feet thick at well P-3 to 183 feet thick at well P-7. The lower Hawthorn Confining Zone is made up primarily of clay and phosphatic clay with occasional interbedded micrite limestone lenses. The top of the lower Hawthorn producing Zone (Tampa Formation) is present from 505 feet bls at well P-3 to 430 feet bls at well P-7 and consists of yellowish gray and light gray limestone and sandy limestone. The lower Hawthorn producing zone represents the top of the upper Floridan Aquifer System.

3.3.3 Oligocene Series

Suwannee Limestone. The Oligocene Suwannee Limestone was encountered at depths between 664 feet bls at P-3 and 518 feet bls at well P-7 and is characterized by a yellowish gray, fine grained, porous limestone. The Suwannee Limestone is part of the upper Floridan Aquifer System, and characteristically exhibits high permeability and artesian pressure.

Section 4 Hydrogeologic Testing



SECTION 4

Hydrogeologic Testing

Hydrogeologic testing during the construction of the new production wells included analysis of formation samples, reverse-air pilot hole water sampling, geophysical logging, reverse-air drilling specific capacity testing, packer testing, and aquifer performance testing. Results of the hydrogeologic testing were used to determine the characteristics of the strata intercepted by the borehole, which, in turn, were used to determine the final designs of the wells.

The two final portions of the testing program were designed to determine the transmissivity (T) and storativity (S) of the penetrated aquifer. Transmissivity is a measure of the capacity of an aquifer to transmit water and is defined as the amount of water that can flow through a vertical section of an aquifer of a certain width extending the full saturated height of the aquifer under a certain hydraulic gradient. Transmissivity is expressed in square feet per day (ft²/day) and gallons per day per foot (gpd/ft) in this report. Storativity is a measure of the volume of water that an aquifer releases from storage per unit surface area of the aquifer per unit change in hydraulic head or pressure. Storativity is a dimensionless parameter.

4.1 Formation Sampling

Formation samples (drill cuttings) from the production wells were collected at 10-foot intervals from land surface to the total depth of the well and were characterized for rock type, color, consolidation, porosity, and fossils. A generalized summary of the geologic formations encountered during construction of the wells is presented in Figure 3-2. Detailed lithologic descriptions of the samples are provided in Appendix B.

4.2 Geophysical Logging

Geophysical logs were performed in the pilot hole intervals of the wells to correlate formation samples taken during drilling, to identify formation boundaries, to aid in the selection of packer testing intervals, and to obtain specific geologic and hydrogeologic data pertaining to the underground formations. These data were then used to assist in the selection of the casing setting depths. Reamed hole caliper logs were also performed prior to casing installation to confirm the borehole diameter. Tables 4-1 through 4-5 provide a summary of geophysical logging conducted during well construction. Copies of the geophysical logs performed on each well are provided in Appendix F. Copies of the video logs performed on each well and video log summaries are provided in Appendix G (Appendix G.2 of Volume III contains the video tapes).

A stratigraphic profile of the site was derived from the correlation of formation samples with geophysical logs performed during pilot hole drilling. Strata encountered during construction of the wells ranged in age from Holocene to Oligocene Age deposits. The stratigraphic units and their respective ages are as follows: undifferentiated Holocene and Pleistocene Age sediments, the Hawthorn Group of Miocene Age and the Suwannee

Limestone of Oligocene Age. Figure 4-1 shows the correlation of natural gamma ray logs for wells P-3 through P-7.

TABLE 4-1
Well P-3 Geophysical Logging Activities
City of Fort Myers WTP – Well Completion Report (P-3 through P-7)

Logging Event	Date	Well Progress and Casing Depth	Type of Log Run ¹	Purpose
1	May 15	12.25-inch Pilot Hole to 100 feet bls	C, GR, DI, SP	Evaluate Surficial Aquifer and Peace River Formation; Determine Shallow Casing Setting Depth
2	May 16	30-inch Reamed Hole to 97 feet bls	C	Confirm Reamed Hole Characteristics
3	May 19	12.25-inch Pilot Hole to 550 feet bls	C, GR, SP, DI	Evaluate Arcadia Formation; Determine Final Casing Setting Depth
4	May 25	24-inch Reamed Hole to 515 feet bls; Final Casing to 510 feet bls	C,GR	Confirm Reamed Hole Characteristics
5	June 12	7-7/8-inch Pilot Hole to 894 feet bls	C, GR, SSP, DI, SFT, SFR, SFM, DFT, DFM, DFR	Evaluate Hydrogeology of the Arcadia and Suwannee Formations
6	June 21	13-5/8-inch Pilot Hole to 837; Final Casing to 510 feet bls	C, GR, VIDEO	Evaluate Hydrogeology of the Arcadia and Suwannee Formations

¹ Legend:

C – Caliper	SFM – Static Flowmeter
GR - Natural Gamma Ray	DI – Dual Induction
SP - Spontaneous Potential	DFT – Dynamic Fluid Temperature
SFR – Static Fluid Resistivity	DFR – Dynamic Fluid Resistivity
SFT - Static Fluid Temperature	DFM – Dynamic Flowmeter

bls - below land surface

TABLE 4-2
P-4 Geophysical Logging Activities
City of Fort Myers WTP – Well Completion Report (P-3 through P-7)

Logging Event	Date	Well Progress and Casing Depth	Type of Log Run ¹	Purpose
1	May 15	7.7/8-inch Pilot Hole to 100 feet bls	C, GR, DI, SP	Evaluate Surficial Aquifer and Peace River Formation; Determine Shallow Casing Setting Depth
2	May 16	30-inch Reamed Hole to 94 feet bls	C	Confirm Reamed Hole Characteristics
3	May 19	7-7/8-inch Pilot Hole to 562 feet bls	C, GR, SP, DI	Evaluate Arcadia Formation; Determine Final Casing Setting Depth
4	June 1	24-inch Reamed Hole to 518 feet bls; Final Casing to 510 feet bls	C,GR	Confirm Reamed Hole Characteristics
5	June 9	7-7/8-inch Pilot Hole to 895 feet bls	C, GR, SSP, DI, SFT, SFR, SFM, DFT, DFM, DFR	Evaluate Hydrogeology of the Arcadia and Suwannee Formations
6	June 21	13-5/8-inch Pilot Hole to 837; Final Casing to 510 feet bls	C, GR, VIDEO	Evaluate Hydrogeology of the Arcadia and Suwannee Formations

¹ Legend:

C – Caliper	SFM - Static Flowmeter
GR – Natural Gamma Ray	DI – Dual Induction
SP - Spontaneous Potential	DFT - Dynamic Fluid Temperature
SFR – Static Fluid Resistivity	DFR - Dynamic Fluid Resistivity
SFT - Static Fluid Temperature	DFM - Dynamic Flowmeter

bls - below land surface

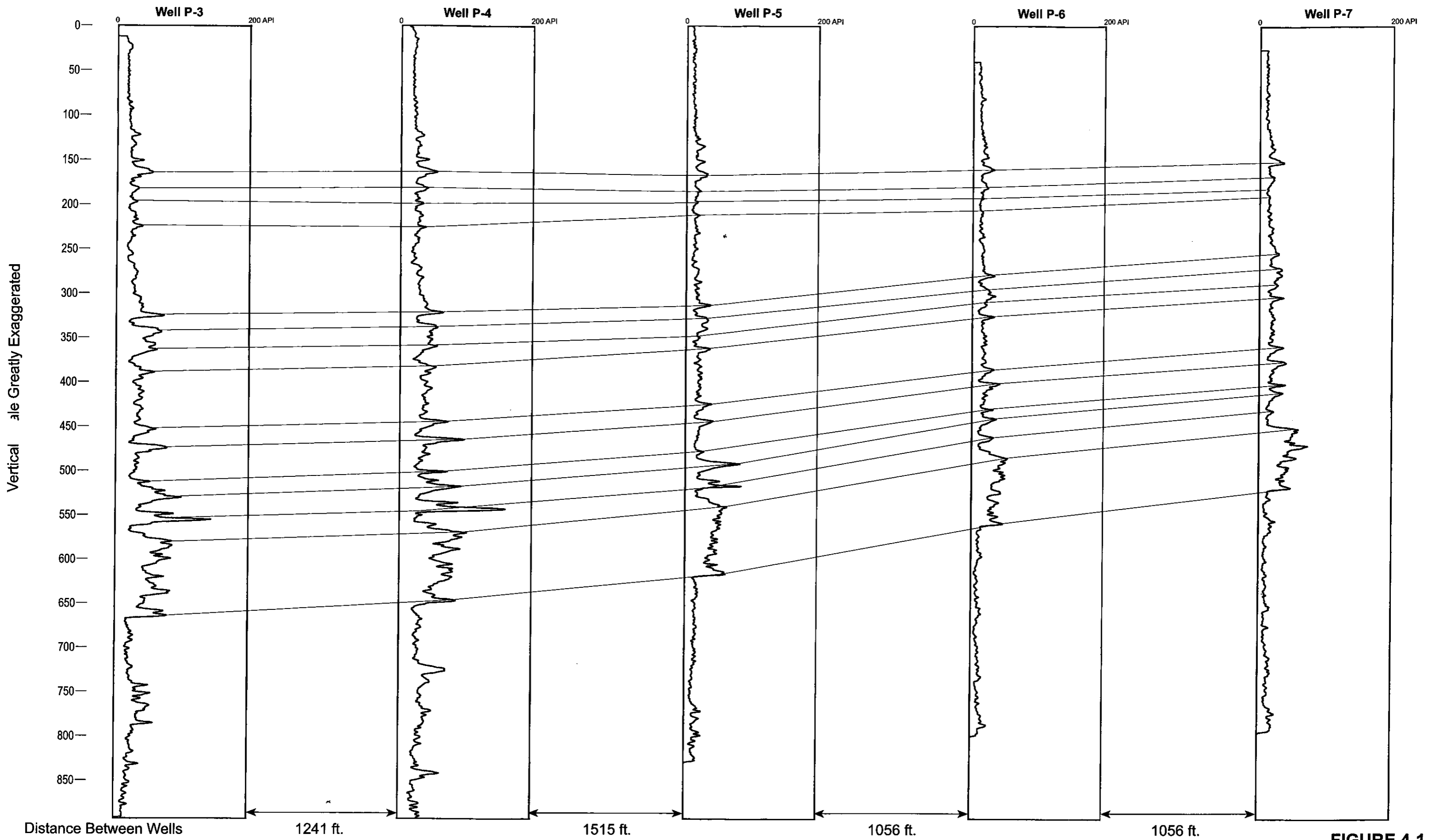

FIGURE 4-1
Wells P-3 through P-7
Gamma Ray Log Correlation

TABLE 4-3
 Well P-5 Geophysical Logging Activities
 City of Fort Myers WTP – Well Completion Report (P-3 through P-7)

Logging Event	Date	Well Progress and Casing Depth	Type of Log Run ¹	Purpose
1	July 3	7-7/8-inch Pilot Hole to 110 feet bls	C, GR, DI, SP	Evaluate Surficial Aquifer and Peace River Formation; Determine Shallow Casing Setting Depth
2	July 6	32-inch Reamed Hole to 94 feet bls	C	Confirm Reamed Hole Characteristics
3	July 11	7-7/8-inch Pilot Hole to 523 feet bls	C, GR, SP, DI	Evaluate Arcadia Formation; Determine Final Casing Setting Depth
4	July 18	24-inch Reamed Hole to 485 feet bls; Final Casing to 480 feet bls	C,GR	Confirm Reamed Hole Characteristics
5	July 27	7-7/8-inch Pilot Hole to 832 feet bls	C, GR, SSP, DI, SFT, SFR, SFM, DFT, DFM, DFR	Evaluate Hydrogeology of the Arcadia and Suwannee Formations
6	August 1	13-5/8-inch Pilot Hole to 832; Final Casing to 480 feet bls	C, GR, VIDEO	Evaluate Hydrogeology of the Arcadia and Suwannee Formations

¹ Legend:

C – Caliper	SFM - Static Flowmeter
GR - Natural Gamma Ray	DI – Dual Induction
SP - Spontaneous Potential	DFT - Dynamic Fluid Temperature
SFR – Static Fluid Resistivity	DFR - Dynamic Fluid Resistivity
SFT - Static Fluid Temperature	DFM - Dynamic Flowmeter

bls - below land surface

TABLE 4-4
 Well P-6 Geophysical Logging Activities
 City of Fort Myers WTP – Well Completion Report (P-3 through P-7)

Logging Event	Date	Well Progress and Casing Depth	Type of Log Run ¹	Purpose
1	August 10	7-7/8-inch Pilot Hole to 92 feet bls	C, GR, DI, SP	Evaluate Surficial Aquifer and Peace River Formation; Determine Shallow Casing Setting Depth
2	August 16	32-inch Reamed Hole to 92 feet bls	C	Confirm Reamed Hole Characteristics
3	August 29	7-7/8-inch Pilot Hole to 562 feet bls	C, GR, SP, DI	Evaluate Arcadia Formation; Determine Final Casing Setting Depth
4	September 5	24-inch Reamed Hole to 448 feet bls; Final Casing to 445 feet bls	C,GR	Confirm Reamed Hole Characteristics
5	September 14	7-7/8-inch Pilot Hole to 805 feet bls	C, GR, SSP, DI, SFT, SFR, SFM, DFT, DFM, DFR	Evaluate Hydrogeology of the Arcadia and Suwannee Formations
6	September 19	13-5/8-inch Pilot Hole to 825; Final Casing to 445 feet bls	C, GR, VIDEO	Evaluate Hydrogeology of the Arcadia and Suwannee Formations

¹ Legend:

C - Caliper	SFM - Static Flowmeter
GR - Natural Gamma Ray	DI – Dual Induction
SP - Spontaneous Potential	DFT - Dynamic Fluid Temperature
SFR – Static Fluid Resistivity	DFR - Dynamic Fluid Resistivity
SFT - Static Fluid Temperature	DFM - Dynamic Flowmeter

bls - below land surface

tested interval. The normalized specific capacity curve presented in Figures 4-2 through 4-6 allows an evaluation of the productivity of the borehole which is unbiased by the amount of open borehole during testing.

4.3.1 Well P-3 Drilling Specific Capacity Testing

A significant increase in specific capacity was observed between 739 feet and 770 feet bls, suggesting this interval is very productive, as shown in Table 4-6 and Figure 4-2. The geophysical flowmeter log interpretation shows the same large increase in flow as 40 percent of the flow in well P-3 originates between 745 feet bls and 775 feet bls. A decrease in normalized specific capacity was observed between 800 feet and 832 feet bls, and the pilot hole was backfilled to 837 feet bls.

TABLE 4-6
Well P-3 Reverse-Air Drilling Specific Capacity Tests Data Summary
City of Fort Myers WTP – Well Completion Report (P-3 through P-7)

Test Interval (ft bls)	Pumping Rate (gpm)	Drawdown (feet)	Specific Capacity (gpm/ft)	Normalized Specific Capacity (gpm/ft)
510 - 581	127	77.8	1.6	0.023
510 - 614	114	70.7	1.6	0.015
510 - 646	108	48.4	2.3	0.016
510 - 677	137	38.0	3.6	0.022
510 - 707	16	17.8	9.2	0.046
510 - 739	150	15.2	9.8	0.043
510 - 770	150	5.0	30	0.115
510 - 800	148	4.6	32	0.110
510 - 832	156	5.5	28	0.087
510 - 864	169	4.5	38	0.107
510 - 894	184	5.0	37	0.095

4.3.2 Well P-4 Drilling Specific Capacity Testing

As presented in Table 4-7 and Figure 4-3, an increase in specific capacity was observed between 688 feet and 720 feet bls and again between 751 feet and 782 feet bls, suggesting these intervals are very productive. The geophysical flowmeter log interpretation also notes the same significant increase in flow as the specific capacity tests, with approximately 66 percent of the borehole flow originating between 676 feet bls and 785 feet bls. Decreasing normalized specific capacity values below a depth of 814 feet bls indicate this interval is less productive.

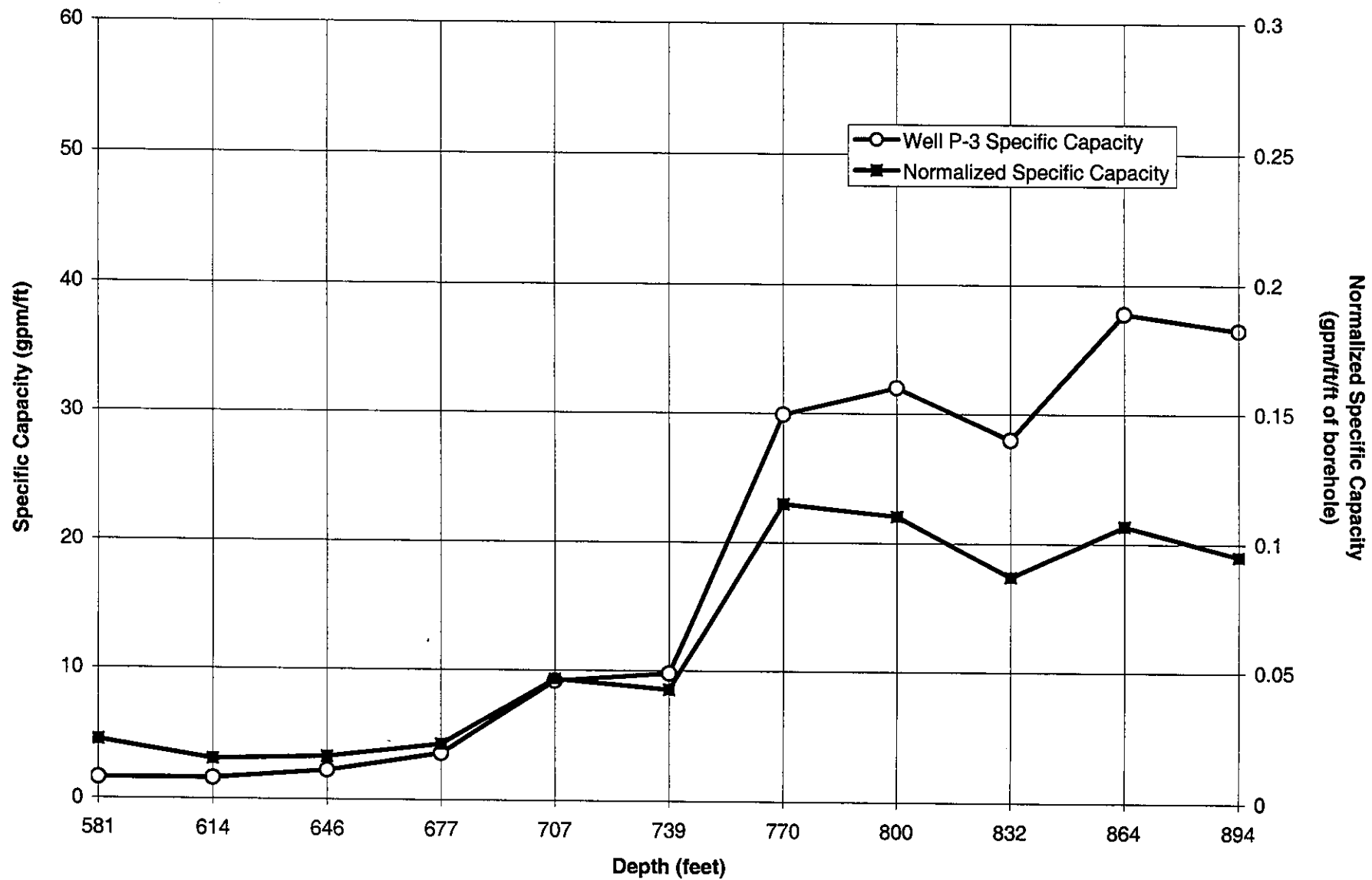

FIGURE 4-2
Well P-3 Reverse-Air Specific Capacity Results

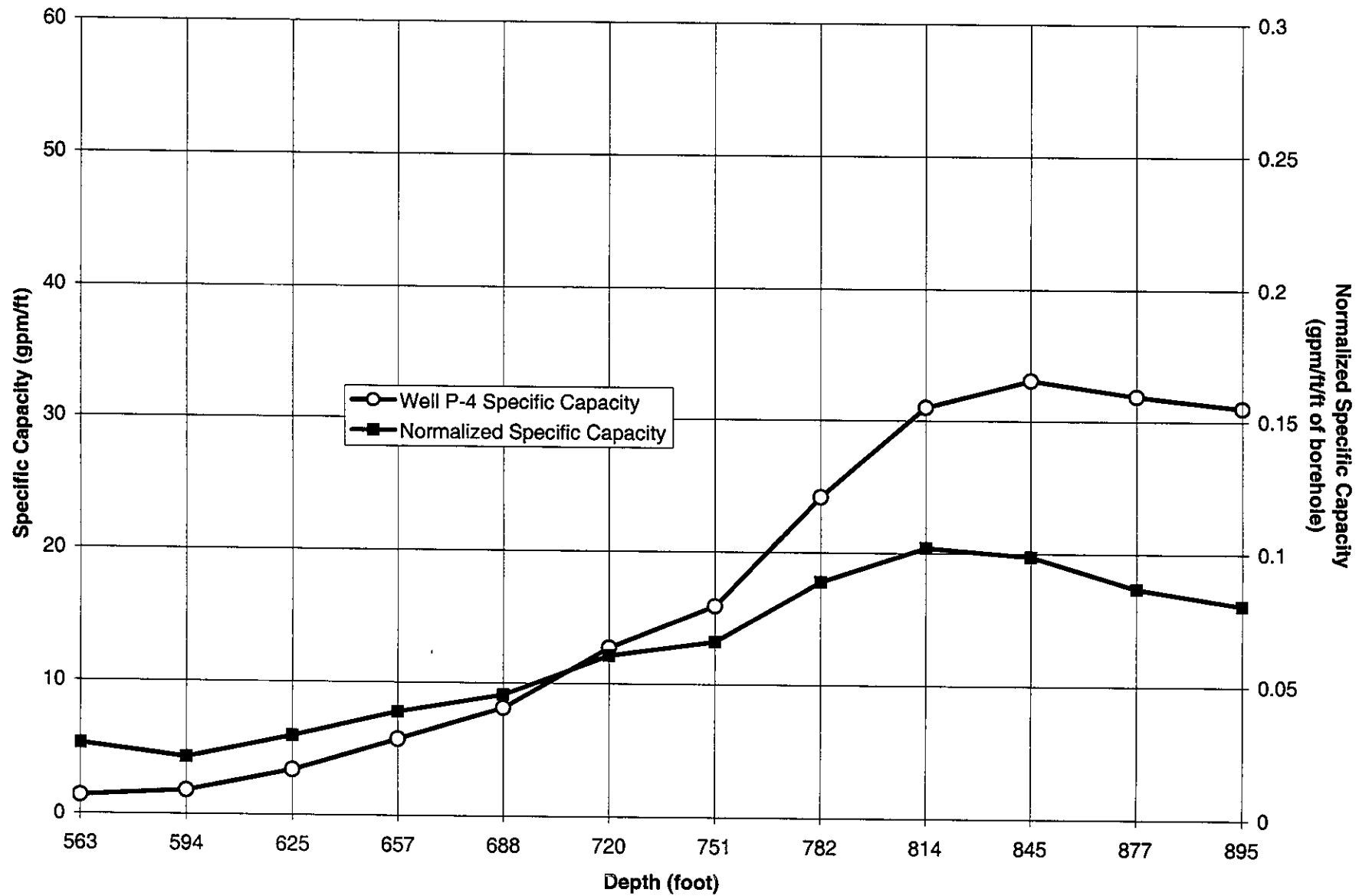

FIGURE 4-3
Well P-4 Reverse-Air Specific Capacity Results

TABLE 4-7
 Well P-4 Reverse-Air Drilling Specific Capacity Tests Data Summary
 City of Fort Myers WTP – Well Completion Report (P-3 through P-7)

Test Interval (ft bls)	Pumping Rate (gpm)	Drawdown (feet)	Specific Capacity (gpm/ft)	Normalized Specific Capacity (gpm/ft)
510 - 563	112	83.0	1.3	0.026
510 - 594	126	67.6	1.8	0.021
510 - 625	149	43.4	3.4	0.029
510 - 657	143	25.1	5.7	0.038
510 - 688	127	15.6	8.1	0.046
510 - 720	174	13.8	13	0.060
510 - 751	189	11.9	16	0.066
510 - 782	172	7.1	24	0.089
510 - 814	195	6.3	31	0.102
510 - 845	194	5.9	33	0.099
510 - 877	179	5.6	32	0.086
510 - 895	149	5.6	27	0.081

4.3.3 Well P-5 Drilling Specific Capacity Testing

Tables 4-8 and Figure 4-4, present air-lift specific capacity values from well P-5. A significant increase in specific capacity was observed between 677 feet and 709 feet bls, suggesting this interval is very productive. The geophysical flowmeter log interpretation also correlates with the same large flow increase as the specific capacity test, with approximately 50 percent of the borehole flow originating between 683 feet and 726 feet bls. Decreasing normalized specific capacity values are noted below a depth of 801 feet bls indicating that this interval is less productive.

TABLE 4-8
 Well P-5 Reverse-Air Drilling Specific Capacity Tests Data Summary
 City of Fort Myers WTP – Well Completion Report (P-3 through P-7)

Test Interval (ft bls)	Pumping Rate (gpm)	Drawdown (feet)	Specific Capacity (gpm/ft)	Normalized Specific Capacity (gpm/ft)
480 - 523	39	104	0.4	0.009
480 - 554	100	57.0	1.4	0.018
480 - 585	117	42.8	2.8	0.026
480 - 616	143	3.0	8.0	0.059
480 - 647	167	14.8	10	0.062
480 - 677	174	9.9	18	0.089
480 - 709	192	6.0	32	0.140
480 - 739	197	5.1	39	0.152
480 - 770	190	4.2	46	0.155
480 - 801	170	3.2	58	0.181
480 - 832	176	3.9	45	0.128

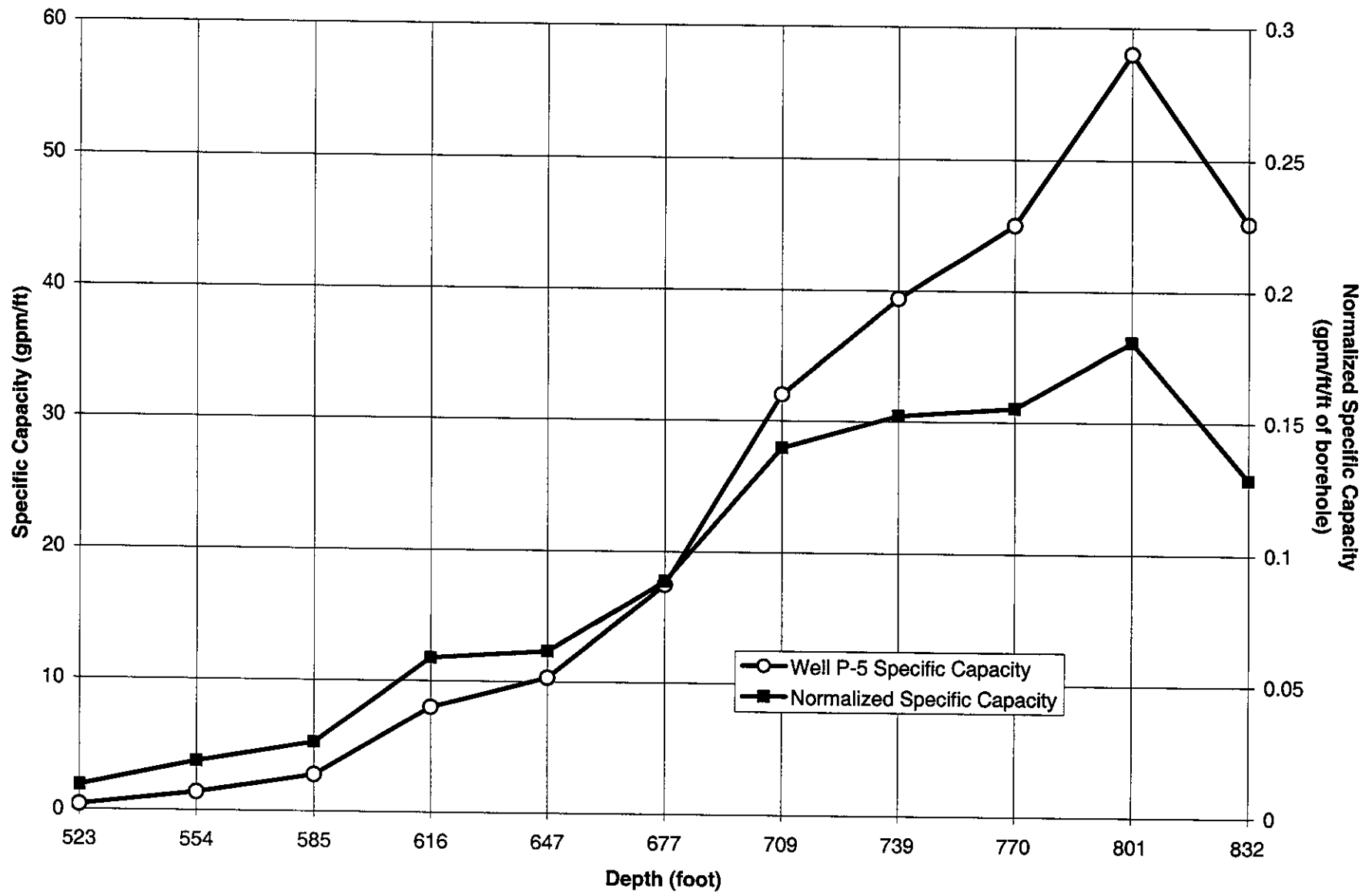

FIGURE 4-4
Well P-5 Reverse-Air Specific Capacity Results

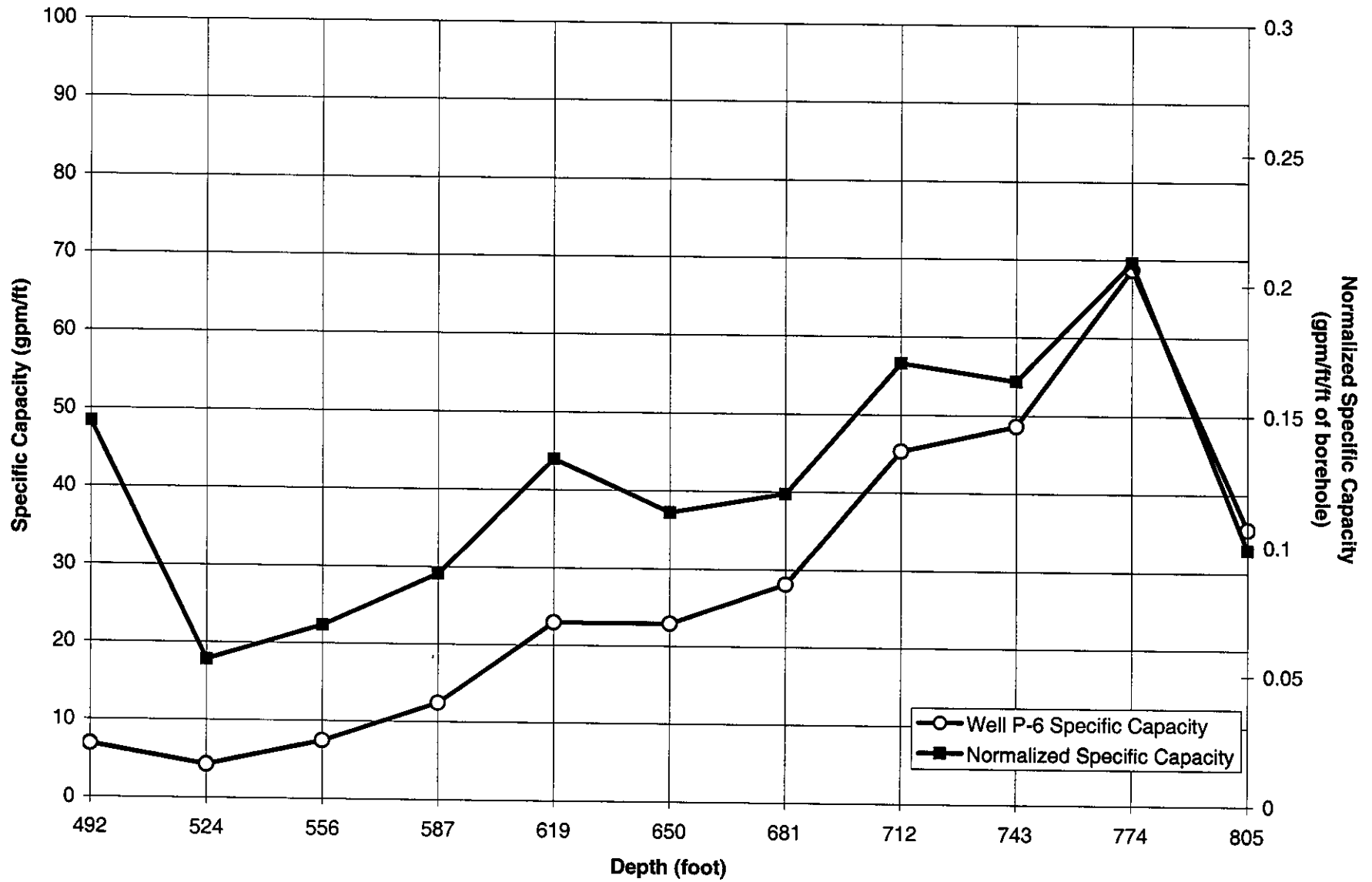

FIGURE 4-5
Well P-6 Reverse-Air Specific Capacity Results

4.3.4 Well P-6 Drilling Specific Capacity Testing

Tables 4-9 and Figure 4-5 present specific capacity data taken from well P-6. Major productive intervals were observed between 587 feet and 619 feet bls and between 681 feet and 712 feet bls. The geophysical flowmeter log indicates approximately 50 percent of the borehole flow originating between 655 feet and 722 feet bls, while decreasing normalized specific capacity values below a depth of 774 feet indicate that the bottom of the well is less productive.

TABLE 4-9
Well P-6 Reverse-Air Drilling Specific Capacity Tests Data Summary
City of Fort Myers WTP – Well Completion Report (P-3 through P-7)

Test Interval (ft bls)	Pumping Rate (gpm)	Drawdown (feet)	Specific Capacity (gpm/ft)	Normalized Specific Capacity (gpm/ft)
445 - 492	125	18.5	6.8	0.145
445 - 524	78	17.8	4.2	0.053
445 - 556	116	15.8	7.4	0.067
445 - 587	101	8.2	12	0.087
445 - 619	152	6.6	23	0.131
445 - 650	129	5.7	23	0.111
445 - 681	144	5.1	28	0.119
445 - 712	145	3.2	45	0.169
445 - 743	141	2.9	49	0.163
445 - 774	162	2.4	69	0.209
445 - 805	114	3.2	36	0.098

4.3.5 Well P-7 Drilling Specific Capacity Testing

Tables 4-10 and Figure 4-6 present specific capacity data for well P-7. Between 535 feet and 566 feet bls and 690 feet and 720 feet bls specific capacity values increased sharply suggesting these intervals are very productive. This is confirmed by the geophysical flowmeter log which shows increases in flow with approximately 25 percent of the borehole flow originating between 670 feet and 718 feet bls and 40 percent of the flow originating between 525 feet and 580 feet bls. As with the other wells, the lower portion of the borehole below 782 feet bls is significantly less productive as shown by the normalized specific capacity values.

TABLE 4-10
Well P-7 Reverse-Air Drilling Specific Capacity Tests Data Summary
City of Fort Myers WTP – Well Completion Report (P-3 through P-7)

Test Interval (ft bls)	Pumping Rate (gpm)	Drawdown (feet)	Specific Capacity (gpm/ft)
445 - 475	111	52.8	0.07
445 - 502	142	25.0	0.10
445 - 535	180	12.0	0.17
445 - 566	153	5.4	0.23
445 - 597	159	4.5	0.23
445 - 629	164	3.9	0.23
445 - 659	191	4.6	0.19
445 - 690	191	3.4	0.23
445 - 720	151	1.0	0.55
445 - 752	190	2.5	0.25
445 - 782	191	2.0	0.28
445 - 800	150	1.9	0.22

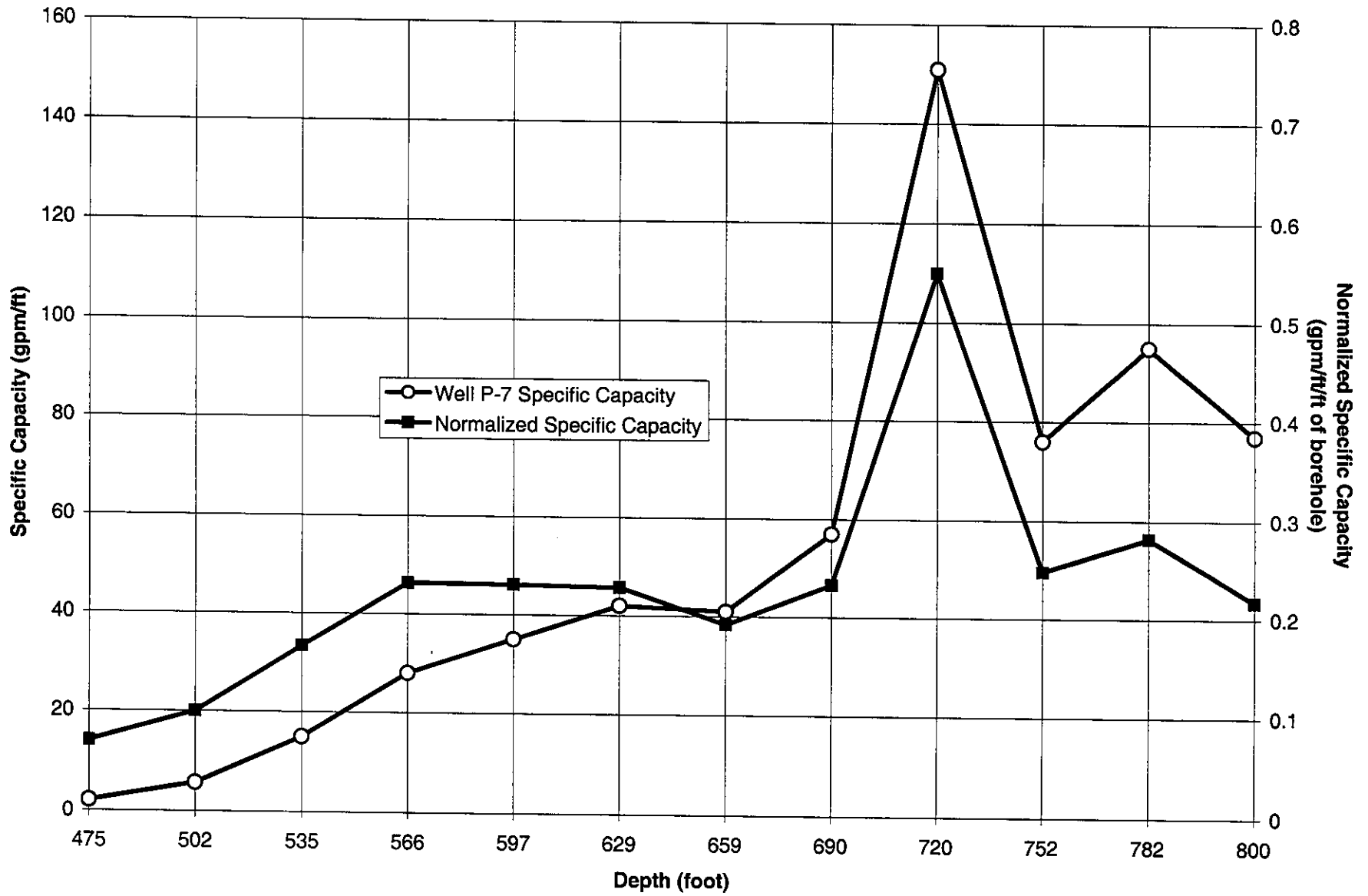

FIGURE 4-6
Well P-7 Reverse-Air Specific Capacity Results

TABLE 4-5
 Well P-7 Geophysical Logging Activities
 City of Fort Myers WTP – Well Completion Report (P-3 through P-7)

Logging Event	Date	Well Progress and Casing Depth	Type of Log Run ¹	Purpose
1	July 10	7-7/8-inch Pilot Hole to 106 feet bls	C, GR, DI, SP	Evaluate Surficial Aquifer and Peace River Formation; Determine Shallow Casing Setting Depth
2	July 20	32-inch Reamed Hole to 77 feet bls	C	Confirm Reamed Hole Characteristics
3	July 26	7-7/8-inch Pilot Hole to 470 feet bls	C, GR, SP, DI	Evaluate Arcadia Formation; Determine Final Casing Setting Depth
4	August 3	24-inch Reamed Hole to 450 feet bls; Final Casing to 445 feet bls	C,GR	Confirm Reamed Hole Characteristics
5	August 17	7-7/8-inch Pilot Hole to 800 feet bls	C, GR, SSP, DI, SFT, SFR, SFM, DFT, DFM, DFR	Evaluate Hydrogeology of the Arcadia and Suwannee Formations
6	August 23	13-5/8-inch Pilot Hole to 825; Final Casing to 445 feet bls	C, GR, VIDEO	Evaluate Hydrogeology of the Arcadia and Suwannee Formations

¹ Legend:

C – Caliper
 GR - Natural Gamma Ray
 SP - Spontaneous Potential
 SFR – Static Fluid Resistivity
 SFT - Static Fluid Temperature

SFM - Static Flowmeter
 DI – Dual Induction
 DFT - Dynamic Fluid Temperature
 DFR - Dynamic Fluid Resistivity
 DFM - Dynamic Flowmeter

bls - below land surface

4.2.1 Video Logging

Borehole video logs were performed on the production well pilot holes to the total depth of each well. These videos were performed to obtain additional physical (visual) data on the wells. Briefly described summaries of each of these videos are provided in Appendix G.1 contained in this volume. Copies of these videos have been furnished to FDEP Tampa and Tallahassee offices. The videos can also be viewed at CH2M HILL's Tampa office and the City's WTP at 2751 Jacksonville Street.

4.3 Reverse-Air Drilling Specific Capacity Tests

The specific capacity of a well is defined as the rate of discharge per unit of drawdown. It is expressed as gallons per minute per foot of drawdown (gpm/ft).

Reverse-air specific capacity tests were conducted at 30-foot intervals during reverse-air drilling to provide information on the specific capacity of the open hole interval. Each test was conducted for approximately 15 minutes, during which time water level and flow rate measurements were taken to provide data for specific capacity calculations. Tables 4-6 through 4-10 provide a summary of the reverse-air specific capacity data. Figures 4-2 through 4-6 present the reverse-air specific capacity and normalized air-lift specific capacity data with respect to depth for each well. The normalized air-lift specific capacity data were derived by dividing the specific capacity of the given interval by the vertical extent of the

✓ 4.4 Packer Test

One off-bottom packer test was conducted on well P-3 for a depth interval of 820 feet to 894 feet. This interval represents the zone below the bottom of the production interval. The test was run for 4 hours at a pumping rate of 8 gpm. The resulting drawdown was approximately 53 feet which translates into a specific capacity of 0.15 gpm/ft. Due to the nature of packer testing, leakage of water around the packer from the above water column could reduce drawdown effects measured in the target interval. This packer test showed that the geology below the target production interval was non-productive and acts as a semi-confining unit which should impede upward migration of poorer quality water. The tested interval was grouted up after testing.

✓ 4.5 Aquifer Performance Testing

Aquifer performance tests (APTs) were conducted on wells P-3 through P-7 to evaluate the hydrogeologic characteristics and water quality of the open hole interval. Prior to the beginning of the pump tests, each well underwent surge development to remove sand by pumping the well at rates between 2,000 gpm and 3,200 gpm for 5 minutes, then allowing the water level to recover to ground surface. This procedure was repeated for between 3 and 9 hours, depending on water quality and sediment production in each well.

Each pump test on wells P-3 through P-7 included the collection of background water levels, pumping data, and recovery data. It also includes the collection of water samples for analysis as discussed in Section 5. Water levels were measured using pressure transducers and recorded by an electronic data logger. For each pump test, an adjacent well to the pumping well was also monitored with an electronic data logger during pumping and recovery periods. During testing of wells P-3, P-4, P-6, and P-7, additional drawdown and recovery data were recorded from a manometer tube installed on well P-5. Well pumping rates were measured using a digital flow meter and a calibrated 8-inch totalizing flowmeter near the wellhead. Water level data during pumping and recovery for the final pumping test are provided in Appendix H.

Well drawdown data from the each pumping test were analyzed using the Theis curve matching method and Cooper-Jacob straight line method for confined aquifers to calculate transmissivity and storativity of the aquifer. The Hantush Method was used to determine the leakance that was occurring when the aquifer was stressed. The Theis Recovery curve matching technique was used to calculate aquifer transmissivity from the recovery data. Results from the analysis of the pumping test data are presented in Table 4-11 at the end of this section. A further discussion of each pump test is provided below.

4.5.1 Well P-3 Aquifer Performance Test

A pumping test began on well P-3 on November 2, 2000. Water level data collection was done between October 30, 2000, when the pressure transducers were installed, and November 6, 2000, when the pressure transducers were removed from the wells. Water level data for the entire testing period is presented in Figure 4-7.

**Fort Myers Well P-3 Pumping Test
Wells P-3 and P-4 Water Level Data
November 1-5, 2000**

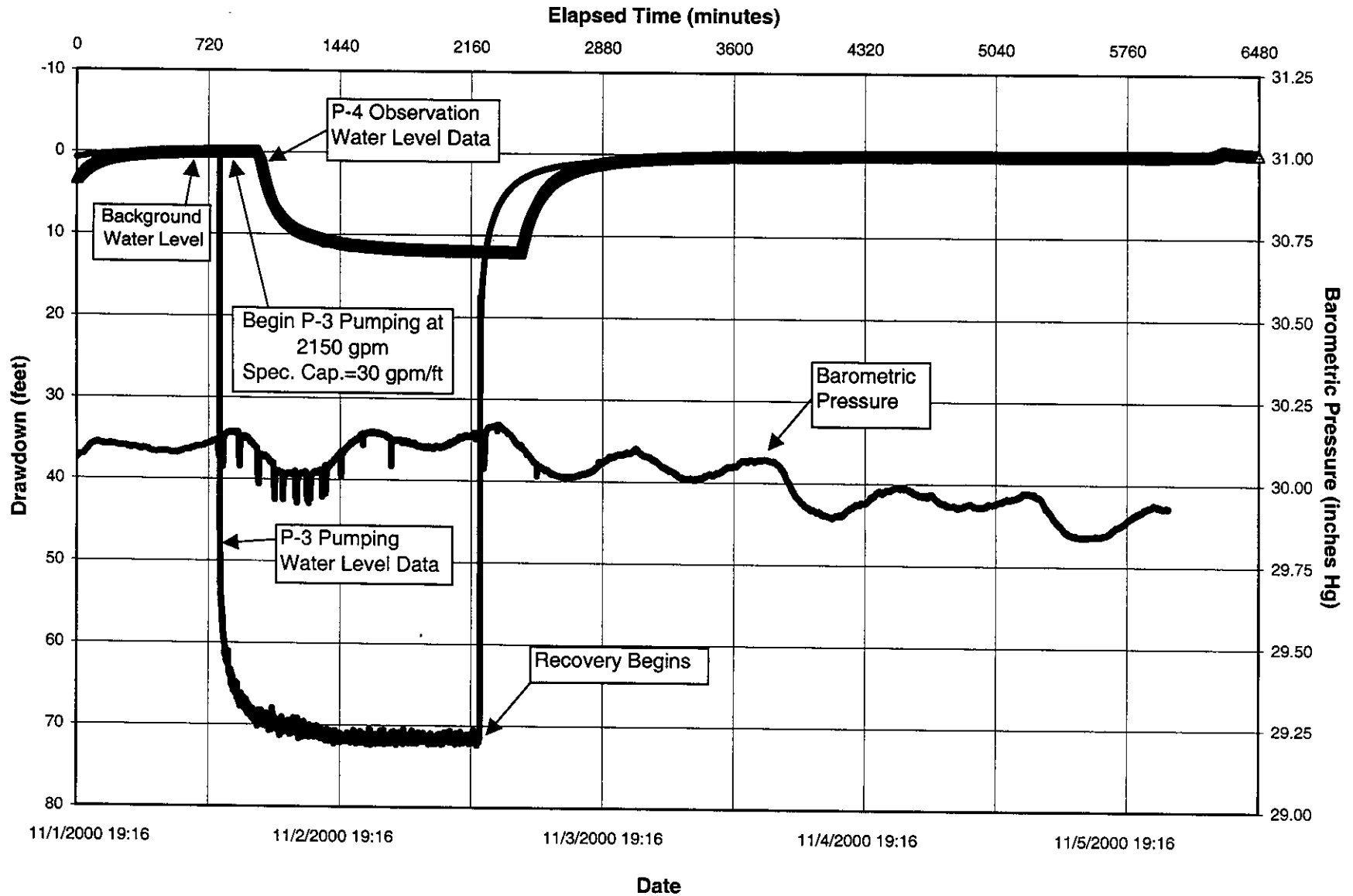

The pumping test began after collecting approximately 17 hours of background water level data. The static water level before the pumping test began was 13.4 feet above land surface (als). Starting on November 2, 2000, well P-3 was pumped at 2,150 gpm for 24 hours. The well was turned off and the water level was allowed to recover for approximately 70 hours until the end of the test on November 6, 2000. Wells P-4 and P-5 were used as observation wells for the pumping conducted on well P-3. A maximum drawdown of approximately 70 feet was measured in well P-3, approximately 12 feet in well P-4, and approximately 5 feet in well P-5.

Based on the analytical and hydraulic limitations of the data collected from the pumping well, the drawdown and recovery data collected from the observation well P-4 appear to be the most accurate information available for describing the aquifer performance characteristics between wells P-3 and P-4. The results from the test analysis are presented in Table 4-11 and the analyses plots are presented in Appendix I.

A calculated aquifer transmissivity of 8,655 square feet per day (ft^2/d) or 64,730 gallons per day per foot (gpd/ft) was determined using the Cooper-Jacob method and an aquifer transmissivity of 7,220 ft^2/day (54,000 gpd/ft) was determined by using the Theis method. Recovery data were analyzed using the Theis Recovery method and transmissivity was determined to be 8,260 ft^2/day (61,780 gpd/ft).

The average transmissivity determined from the drawdown and recovery test data were 8,045 ft^2/day or 60,170 gpd/ft . Assuming an aquifer thickness (B) of 327 feet, the hydraulic conductivity (K) of this interval was 25 feet per day (ft/d). Average aquifer storativity was calculated to be 2.0×10^{-4} , and leakance was calculated to be $1.1 \times 10^{-3} \text{day}^{-1}$.

4.5.2 Well P-4 Aquifer Performance Test

The well P-4 pumping test began on November 9, 2000. All pumping tests and water level data collection occurred between November 8, 2000, when the pressure transducer was installed, and November 13, 2000, when the pressure transducer was removed from the well. Water level data for the entire testing period is presented in Figure 4-8.

The pumping test began after approximately 14 hours of background water level data collection. The static water level in well P-4 after the background period was feet 14.9 als. On November 9, 2000, well P-4 was pumped at 2,400 gpm for 24 hours. The well was turned off and the water level was allowed to recover for approximately 75 hours until the end of the test on November 13, 2000. Wells P-3 and P-5 were used as observation wells for the pumping conducted on well P-4. A maximum drawdown of approximately 97 feet was measured in well P-4, approximately 13 feet in well P-3, and approximately 11 feet in well P-5.

Based on the analytical and hydraulic limitations of the pumping well data, the water level recovery data collected from the observation well P-3 appears to be the most accurate information available for describing the aquifer performance characteristics between wells P-3 and P-4. The results from the test analysis are presented in Table 4-11 and the analyses plots are presented in Appendix I.

**Fort Myers Well P-4 Pumping Test
Wells P-4 and P-3 Water Level Data
November 8-13, 2000**

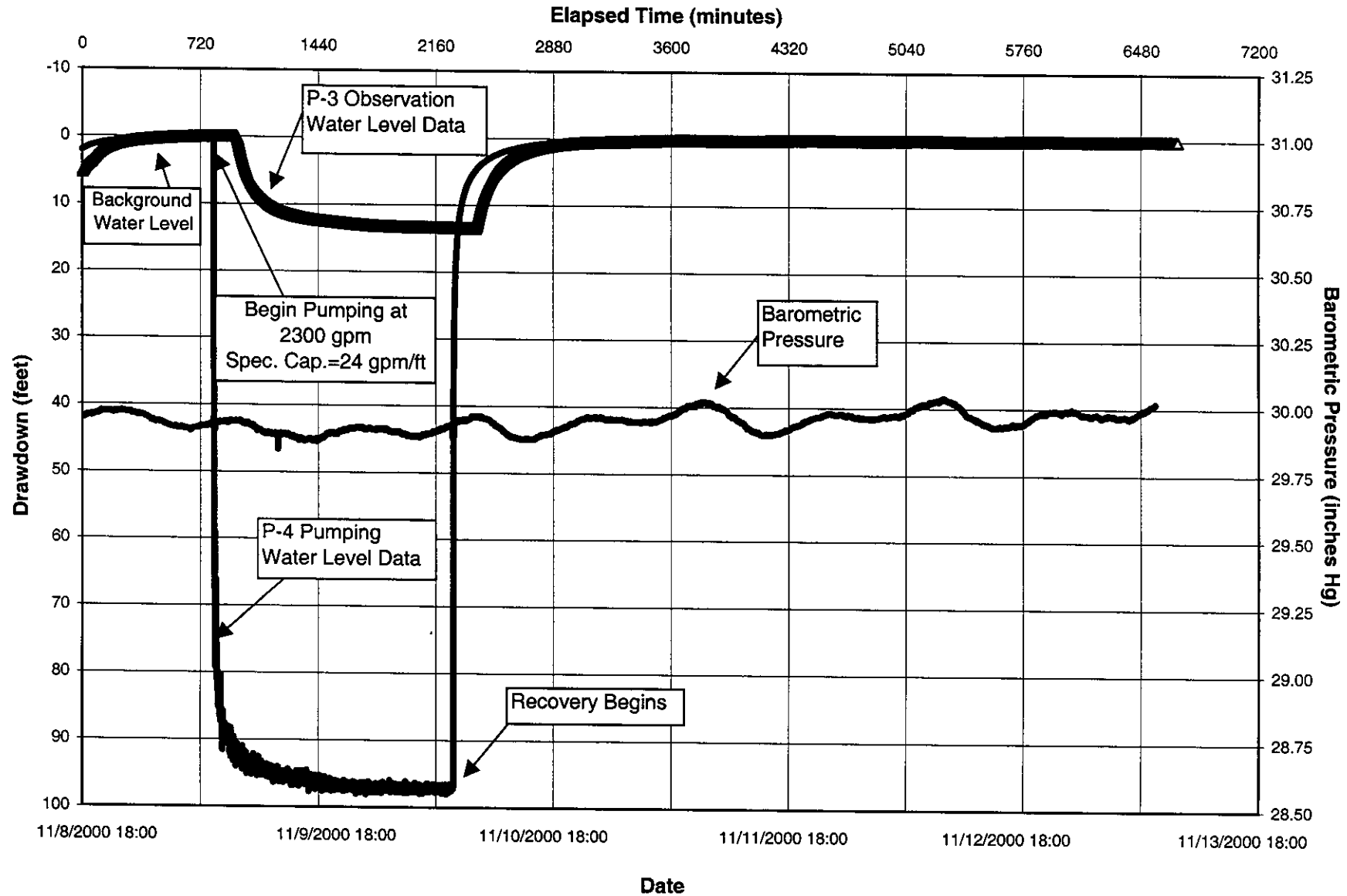

A calculated aquifer transmissivity of 9,120 ft²/day (68,210 gpd/ft) was determined using the Cooper-Jacob method. A calculated aquifer transmissivity of 7,790 ft²/day (58,270 gpd/ft) using the Theis method. Recovery data were analyzed using the Theis Recovery method and transmissivity was determined to be 8,560 ft²/day (64,025 gpd/ft).

The average transmissivity determined from the drawdown and recovery test data were 8,490 ft²/d (63,500 gpd/ft). Assuming an aquifer thickness of 315 feet, the hydraulic conductivity of this interval was 27 ft/d. Average aquifer storativity was calculated to be 1.8×10^{-4} , and leakage was calculated to be $9 \times 10^{-4} \text{day}^{-1}$.

4.5.3 Well P-5 Aquifer Performance Test

A pumping test began on well P-5 on November 27, 2000. All pumping tests and water level data collection occurred between November 17, 2000, when the pressure transducer was installed, and December 5, 2000, when the pressure transducer was removed from the well. Water level data for the entire testing period is presented in Figure 4-9.

The test began after approximately 10 days of background water level data collection. The static water level prior to pumping was 18.6 feet als. On November 27, 2000, well P-5 was pumped at 2,800 gpm for 120 hours (5 days). The well was turned off and the water level was allowed to recover for approximately 70 hours until the end of the test on December 5, 2000. Wells P-2, P-3, P-4, P-6 and P-7 were used as observation wells for the pumping conducted on well P-5. A maximum drawdown of approximately 83 feet was measured in well P-5, approximately 1.7 feet in well P-2, approximately 7.7 feet in well P-3, approximately 12.5 feet in well P-4, approximately 12.2 feet in well P-6 and approximately 5.6 feet in well P-7.

Based on the analytical and hydraulic limitations of the data collected from the pumping well, the drawdown and recovery data collected from the observation wells appear to be the most accurate information available for describing the aquifer performance characteristics between the surrounding wells and pumping well P-5. Other analytical limitations affected the analysis of the pumping test data. The Cooper Jacob method was not applicable on data collected at large distances from the pumping well. Error calculations were made on the pumping and recovery data from wells P-2, P-3, P-4, P-6, and P-7 to determine if this analytical technique could be applied. The results indicated that only the closest wells to well P-5, wells P-4 and P-6, could be analyzed using the Cooper Jacob analysis method. The wells located further from the pumping well contained a range of error in the analytical results that were too high to be accepted. The results from the test analysis are presented in Table 4-11 and the analyses plots are presented in Appendix I.

A calculated aquifer transmissivity of 15,870 ft²/day (118,700 gpd/ft) and 16,460 ft²/day (123,110 gpd/ft) was determined using the Cooper-Jacob method for wells P-4 and P-6, respectively. A calculated aquifer transmissivity of 15,510 ft²/day (116,000 gpd/ft) and 14,960 ft²/day (111,890 gpd/ft) was estimated using the Theis method for wells P-4 and P-6, respectively. A calculated aquifer transmissivity of 13,000 ft²/day (97,230 gpd/ft) was estimated using the Thiem method for all of the wells. Recovery data were analyzed using the Theis Recovery method and transmissivity was determined to be 12,790 ft²/day (95,660 gpd/ft) and 16,850 ft²/day (126,030 gpd/ft) for wells P-4 and P-6, respectively.

**Fort Myers Well P-5 Pumping Test
Well P-4, P-5 and P-6 Water Level Data
November 27-December 5, 2000**

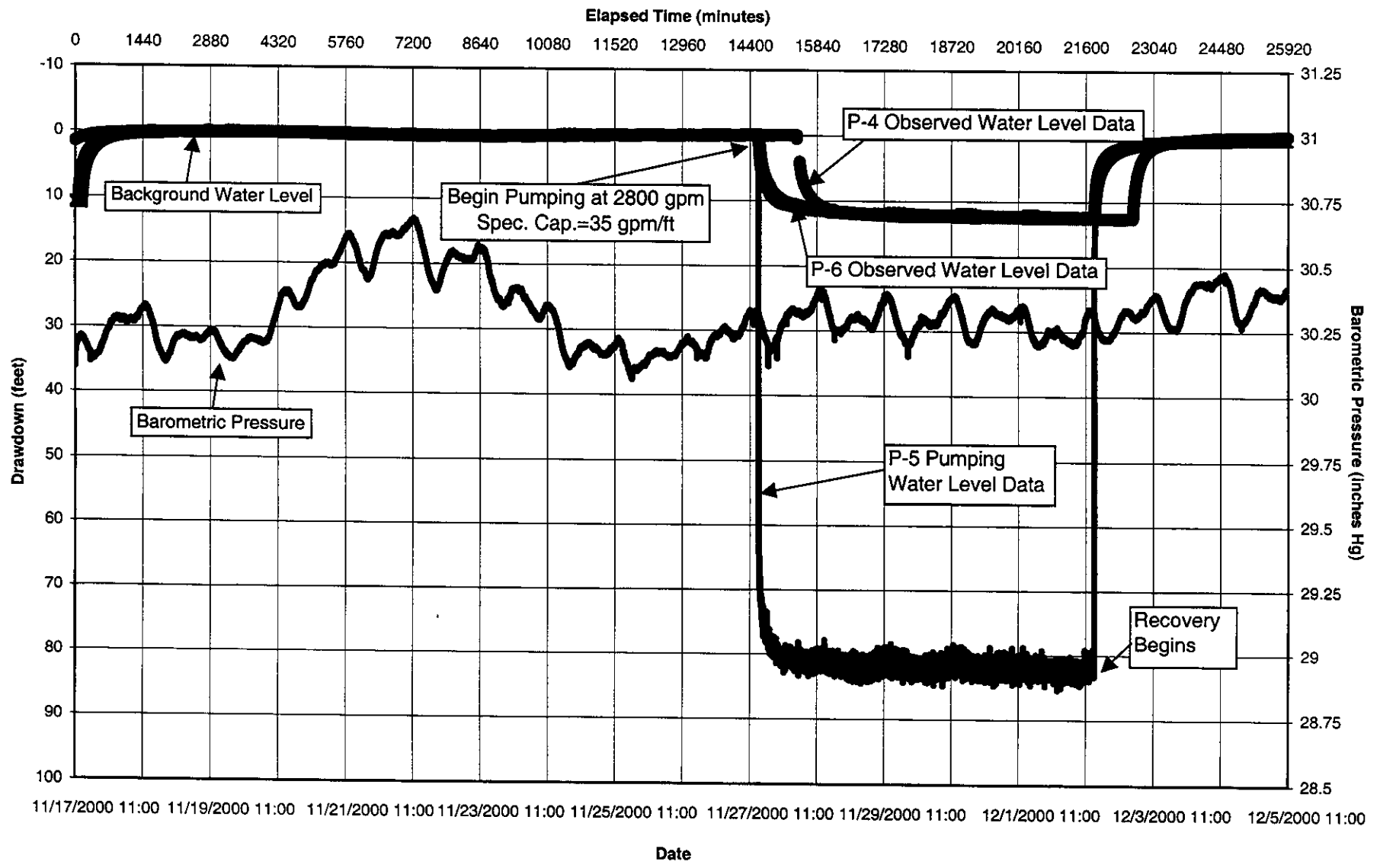

FIGURE 4-9
P-5 Pumping Test Water Level Summary Data

The average transmissivity determined from the drawdown and recovery test data were 15,060 ft²/d (112,660 gpd/ft). Assuming an aquifer thickness of 322 feet, the hydraulic conductivity of this interval was 47 ft/d. Average aquifer storativity was calculated to be 2.2x10⁻⁴, and an average leakance was estimated to be 1.5x10⁻⁴day⁻¹.

4.5.4 Well P-6 Aquifer Performance Test

A pumping test began on well P-6 on October 19, 2000. All pumping tests and water level data collection occurred between October 16, 2000, when the pressure transducer was installed, and October 23, 2000, when the pressure transducer was removed from the well. Water level data for the entire testing period is presented in Figure 4-10.

The test began after approximately 65 hours of background water level data collection. The static water level in well P-6 before pumping began was 17.4 feet als. On October 19, 2000, well P-6 was pumped at 2,300 gpm for 24 hours. The well was turned off and the water level was allowed to recover for approximately 71 hours until the end of the test on October 23, 2000. Wells P-5 and P-7 were used as observation wells for the pumping conducted on well P-6. A maximum drawdown of approximately 65 feet was measured in well P-6, approximately 7 feet in well P-7, and approximately 5 feet in well P-5.

Based on the analytical and hydraulic limitations of the pumping well data, the water level recovery data collected from the observation well P-4 appears to be the most accurate information available for describing the aquifer performance characteristics between wells P-3 and P-4. The results from the test analysis are presented in Table 4-11 and the analyses plots are presented in Appendix I.

A calculated aquifer transmissivity of 21,680 ft²/day (162,155 gpd/ft) was determined using the Cooper-Jacob method. A calculated aquifer transmissivity of 21,740 ft²/day (162,600 gpd/ft) was determined using the Theis method. Recovery data were analyzed using the Theis Recovery method and transmissivity was determined to be 20,360 ft²/day (152,280 gpd/ft).

The average transmissivity determined from the drawdown and recovery test data were 21,260 ft²/d (159,010 gpd/ft). Assuming an aquifer thickness of 360 feet, the hydraulic conductivity of this interval was 60 ft/d. Average aquifer storativity was calculated to be 4.0x10⁻⁴, and leakance was estimated to be 5x10⁻⁴day⁻¹.

4.5.5 Well P-7 Aquifer Performance Test

A pumping test began on well P-7 on October 26, 2000. All pumping tests and water level data collection occurred between October 23, 2000, when the pressure transducer was installed, and October 30, 2000, when the pressure transducer was removed from the well. Water level data for the entire testing period is presented in Figure 4-11.

The test began after approximately 19 hours of background water level data collection. The static water level in well P-7 prior to the pumping test was 17.0 feet als. On October 26, 2000, well P-7 was pumped at 2,300 gpm for 24 hours. Approximately 30 minutes before starting the planned recovery test, the pump failed and recovery began. The well flowed for approximately 20 minutes before the well was closed in. The water level was allowed to recover for approximately 72 hours until the end of the test on October 30, 2000. Wells P-5

**Fort Myers Well P-6 Pumping Test
Well P-6 and P-7 Water Level Data
October 16-23, 2000**

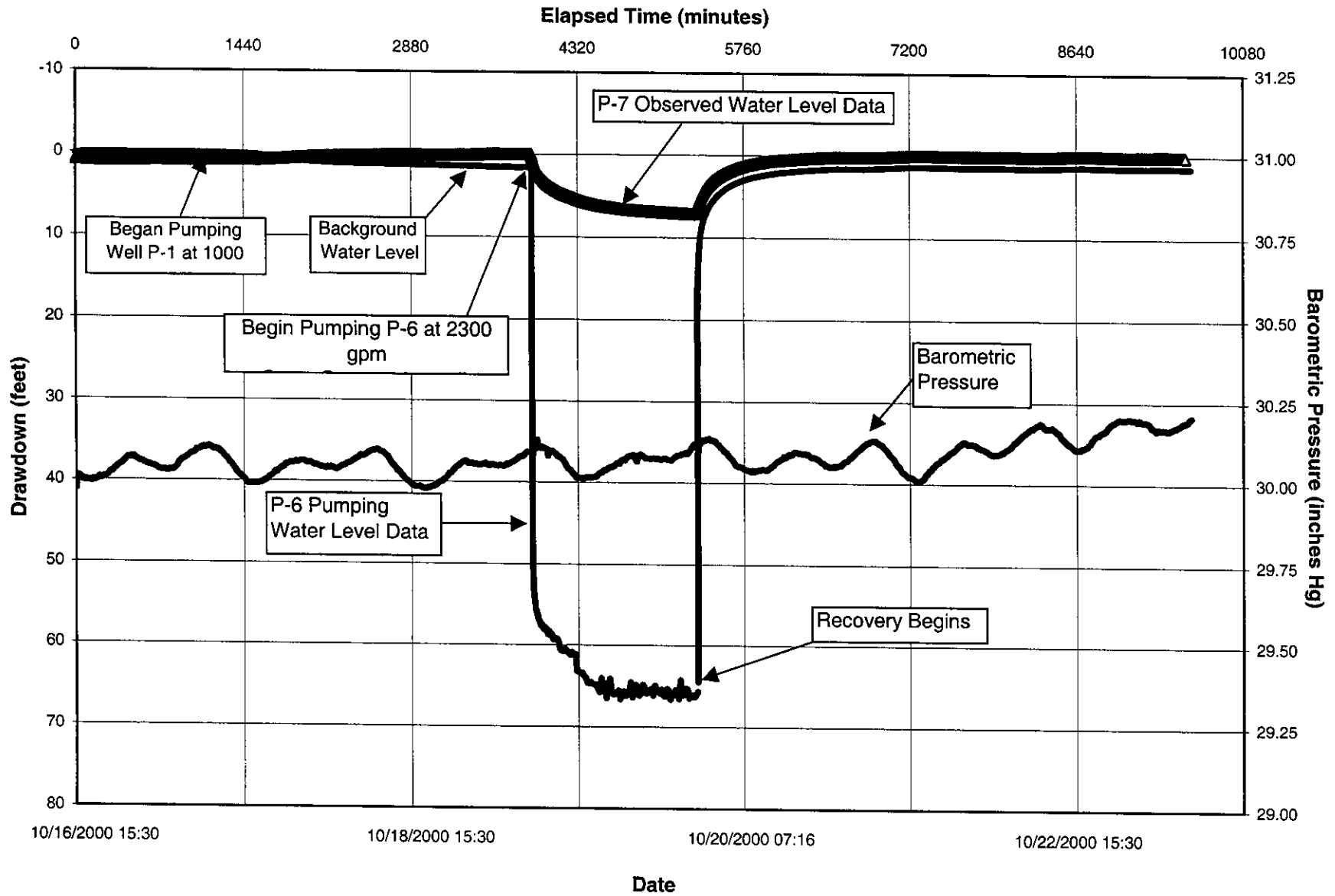

and P-6 were used as observation wells for the pumping conducted on well P-7. A maximum drawdown of approximately 70 feet was measured in well P-7, approximately 12 feet in well P-6, and approximately 5 feet in well P-5.

Based on the analytical and hydraulic limitations of the pumping well data, the water level recovery data collected from the observation well P-4 appears to be the most accurate information available for describing the aquifer performance characteristics between wells P-3 and P-4. The results from the test analysis are presented in Table 4-11 and the analyses plots are presented in Appendix I.

A calculated aquifer transmissivity of 21,370 ft²/day (159,840 gpd/ft) was determined using the Cooper-Jacob method. A calculated aquifer transmissivity of 21,760 ft²/day (162,750 gpd/ft) was determined using the Theis method. Recovery data were analyzed using the Theis Recovery method and transmissivity was determined to be 20,380 ft²/day (152,430 gpd/ft).

The average transmissivity determined from the drawdown and recovery test data were 21,170 ft²/d (158,340 gpd/ft). Assuming an aquifer thickness of 355 feet, the hydraulic conductivity of this interval was also 60 ft/d. Average aquifer storativity was calculated to be 4.7×10^{-4} , and leakance was estimated to be $5 \times 10^{-3} \text{day}^{-1}$.

4.6 Summary of Calculated Aquifer Characteristics

Summaries of calculated hydraulic transmissivity, leakance, and storativity from the pumping tests are provided in Table 4-11. Analysis of the pumping and recovery data indicate that aquifer transmissivity greatly increases between well P-3 and well P-7, from approximately 8,000 ft²/day (60,000 gpd/ft) to 21,000 ft²/day (157,000 gpd/ft). Storativity values also increase by a factor of 2.5 between well P-3, 2.0×10^{-4} , and well P-7, 5×10^{-4} .

An analysis was also completed using the Thiem distance-drawdown method to determine general aquifer transmissivity. The Thiem method utilizes long-term pumping data, gathered from monitoring wells during the P-5 pump test, to estimate transmissivity from steady-state drawdown conditions. Analysis of the drawdown data 500 minutes after pumping began is shown in Figure I-7 found in Appendix I. The Thiem analysis provides an average value for large-scale transmissivity over the entire wellfield. The Thiem method calculates a value of 13,000 ft²/day (97,000 gpd/ft). This value is consistent with the average values using the Cooper-Jacob and Theis methods.

An imprint parameter in analyzing pumping tests and predicting aquifer performance is leakance. Table 4-11 presents the leakance values for the analyzed 24-hour and 5-day pumping tests. Previous published reports present accepted leakance values for the upper Hawthorn/upper Suwannee Producing Zone of approximately $1.0 \times 10^{-4} \text{day}^{-1}$. Analysis of the monitoring well data during the 24-hour and 5-day pumping tests return values within an acceptable range of the reported values, with an average value is $5.8 \times 10^{-4} \text{day}^{-1}$.

**Fort Myers Well P-7 Pumping Test
Well P-7 and P-6 Water Level Data
October 26-30, 2000**

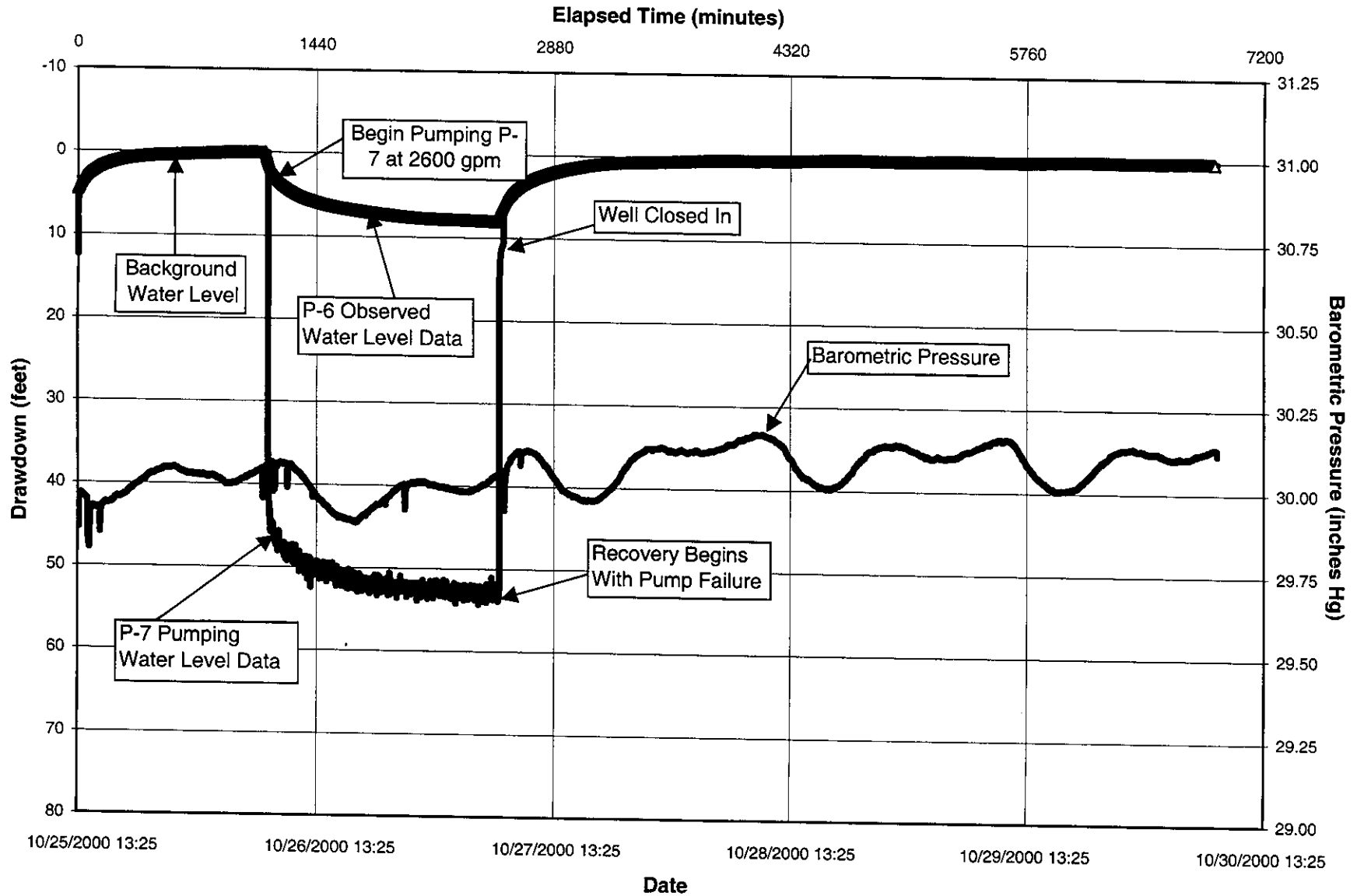

TABLE 4-11
Summary of Aquifer Test Results
City of Fort Myers WTP – Well Completion Report (P-3 through P-7)

Pumping Well	Discharge (gpm)	Test Duration (hours)	Observation Well	Distance (feet)	Drawdown (feet)	Specific Capacity (gpm/ft)	Transmissivity (gpd/ft)	Transmissivity (ft ² /d)	Storativity	Leakance (1/d)	Analysis Method	
P-3	2,150	24 (1 day)	P-3	0.6	71	30	---	---	---	---	---	
			P-4	1100	12	---	64,730	8,655	1.7x10 ⁻⁴	---	CJ	
								54,000	7,220	2.3x10 ⁻⁴	1.1x10 ⁻³	T, H
								61,780	8,260	---	---	R
P-3 Averages =							60,170	8,045	2.0x10⁻⁴	1.1x10⁻³		
P-4	2,400	24 (1 day)	P-4	0.6	97	25	---	---	---	---	---	
			P-3	1100	13.5	---	68,210	9,120	1.7x10 ⁻⁴	---	CJ	
								58,270	7,790	1.9x10 ⁻⁴	9x10 ⁻⁴	T, H
								64,025	8,560	---	---	R
P-4 Averages =							63,500	8,490	1.8x10⁻⁴	9x10⁻⁴		
P-5	2,800	120 (5 days)	P-5	0.6	83	34	---	---	---	---	---	
			All P-2 to P-7	---	---	---	97,230	13,000	---	---	Th	
			P-4	1460	13	---	118,700	15,870	1.6x10 ⁻⁴	---	CJ	
								116,000	15,510	2.3x10 ⁻⁴	3x10 ⁻⁴	T, H
								95,660	12,790	---	---	R
			P-6	1040	12	---	123,110	16,460	2.2x10 ⁻⁴	---	CJ	
								111,890	14,960	2.7x10 ⁻⁴	2x10 ⁻⁴	T, H
								126,030	16,850	---	---	R
P-5 Averages =							112,660	15,060	2.2x10⁻⁴	1.5x10⁻⁴		
P-6	2,300	24 (1 day)	P-6	0.6	66	35	---	---	---	---	---	
			P-7	1050	7	---	162,155	21,680	3.5x10 ⁻⁴	---	CJ	
								162,600	21,740	4.4x10 ⁻⁴	5x10 ⁻⁴	T, H
								152,280	20,360	---	---	R
P-6 Averages =							159,010	21,260	4.0x10⁻⁴	5x10⁻⁴		
P-7	2,300	24 (1 day)	P-7	0.6	53	43	---	---	---	---	---	
			P-6	1050	8	---	159,840	21,370	4.6x10 ⁻⁴	---	CJ	
								162,750	21,760	4.8x10 ⁻⁴	5x10 ⁻⁴	T, H
								152,430	20,380	---	---	R
P-7 Averages =							158,340	21,170	4.7x10⁻⁴	5x10⁻⁴		
Wellfield Averages =							111,140	14,860	2.8x10⁻⁴	5.8x10⁻⁴		

CJ Cooper-Jacob Method (straight line method)
T Theis Method (curve matching)
H Hantush Method (curve matching – used to estimate leakance)
R Recovery Method (Theis & Jacob straight line method)
Th Thiem Method (distance drawdown method)

gpm gallons per minute
ft²/d square feet per day
gpd/ft gallons per day per foot
1/d inverse day

Section 5 Water Quality Testing



SECTION 5

Water Quality Testing

Water samples were collected at various stages of construction and testing to provide data pertinent to decisions regarding the final subsurface design of the wells. Results of pilot hole and final water quality sampling are discussed below. Pilot hole water samples were collected at 30-foot intervals during reverse-air drilling to provide a generalized profile of water quality changes with respect to depth. The samples were field analyzed for chlorides and conductivity. Open circulation reverse-air drilling techniques were used during the pilot hole drilling below the base of the 16-inch casing to the total depth of each well. Pilot hole water quality from each interval reflects a mixture of formation water from the open hole interval from the base of 16-inch casing to the depth at which drilling had reached during the time of sample collection.

Final water quality samples were collected for complete primary and secondary standards in each well, following acidization and the final pumping test. The ambient water quality results are presented in Appendix J. No exceedences of any anthropogenic parameters were noted in the results from any of the wells. A discussion on the results for key parameters is included in this section.

Following the completion of all construction and testing activities, each well was also tested for bacteriological clearance. Between December 7 and December 16, 2000, each well was sampled twice daily for a total of 20 samples. Only one sample, taken on December 14, 2000, from well P-4 contained a positive coliform count. This sample contained two coliform counts and within the satisfactory limits by FDEP standards. All wells satisfactorily met the FDEP requirements for public supply wells.

5.1 Well P-3 Water Quality

The chloride concentration ranged from 810 mg/L to 1,020 mg/L. Concentrations decreased between 614 and 800 feet bls from 1,020 mg/L to 810 mg/L. In the same interval, the specific conductivity decreases from 3,800 $\mu\text{S}/\text{cm}$ to 3,460 $\mu\text{S}/\text{cm}$. Between 800 and 864 feet bls, the chloride concentration increased from 810 mg/L to 860 mg/L and conductivity increases from 3,460 $\mu\text{S}/\text{cm}$ to 3,570 $\mu\text{S}/\text{cm}$. Figure 5-1 and Table 5-1 present a summary of the pilot hole water sampling results.

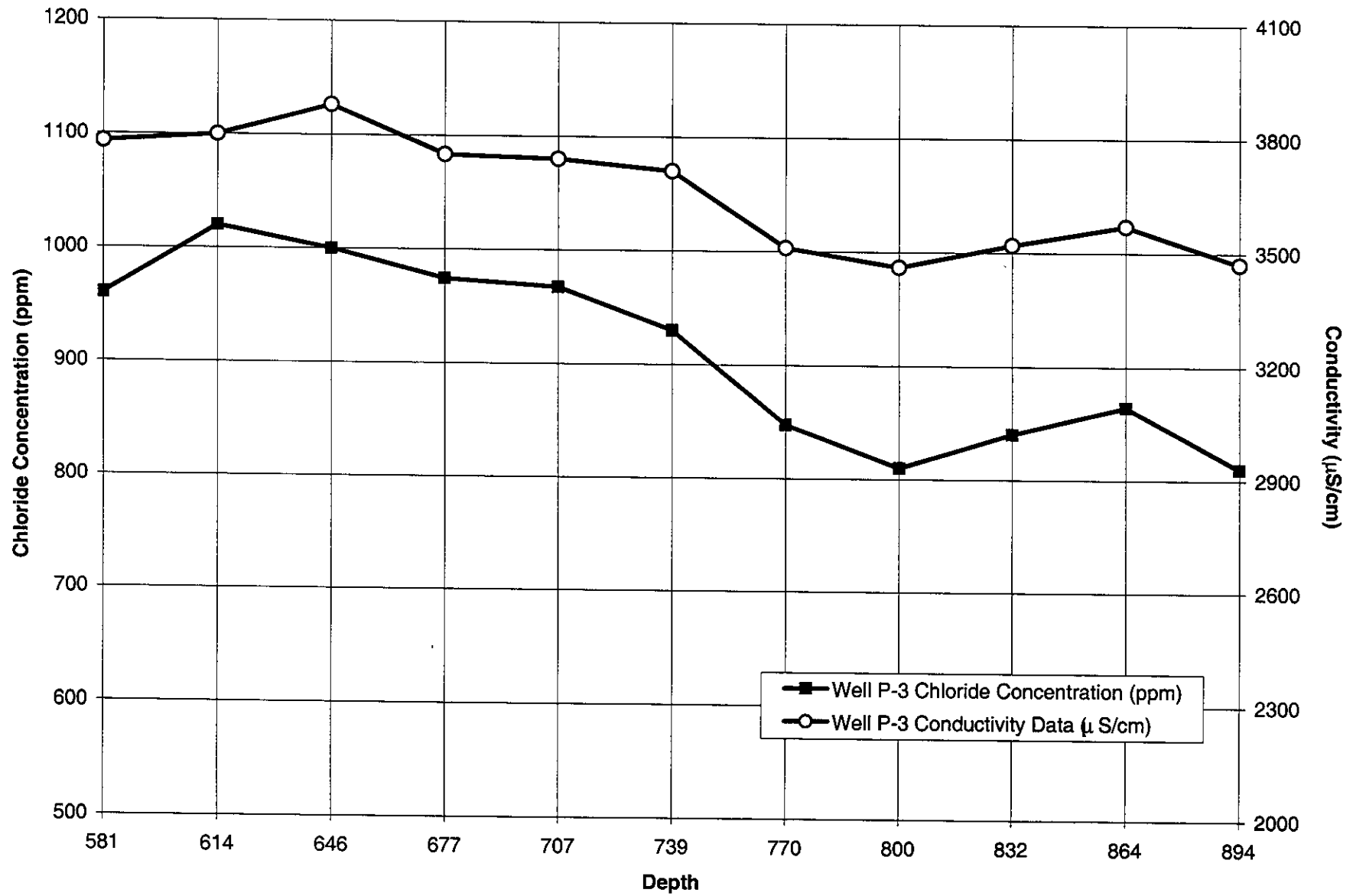

FIGURE 5-1
Well P-3 Pilot Hole Water Quality

TABLE 5-1
 Well P-3 Pilot Hole Water Quality Results
 City of Fort Myers WTP – Well Completion Report (P-3 through P-7)

Depth (feet bls)	Conductivity (μ hos/cm)	Chloride (mg/L)
581	3,780	960
614	3,800	1,020
646	3,880	1,000
677	3,750	970
707	3,740	970
739	3,710	930
770	3,510	850
800	3,460	810
832	3,520	840
864	3,570	860
894	3,470	810

Note: Pilot hole plugged back to 837 feet bls with cement.

5.2 Well P-4 Water Quality

Chloride concentrations and conductivity increased sharply between 563 feet bls and 688 feet bls. The chloride concentration increased from 620 mg/L to 800 mg/L and the conductivity increased from 2,660 μ S/cm to 3,440 μ S/cm over this interval. Between 688 feet bls and 720 feet bls, the chlorides and conductivity decreased. Below 720 feet bls, the chloride concentration was relatively constant, ranging from 720 mg/L to 760 mg/L. The conductivity slightly increases below 720 feet bls, from 3,060 μ S/cm to 3,250 μ S/cm. Figure 5-2 and Table 5-2 present a summary of pilot hole water sample results for well P-4.

TABLE 5-2
 Well P-4 Pilot Hole Water Quality Results
 City of Fort Myers WTP – Well Completion Report (P-3 through P-7)

Depth (feet bls)	Conductivity (μ hos/cm)	Chloride (mg/L)
563	2,660	620
594	2,900	660
625	3,080	720
657	3,350	780
688	3,440	800
720	2,800	720
751	3,060	720
782	3,130	740
814	3,130	740
845	3,170	760
877	3,250	760
895	3,200	740

Note: Pilot hole plugged back to 825 feet bls with cement.

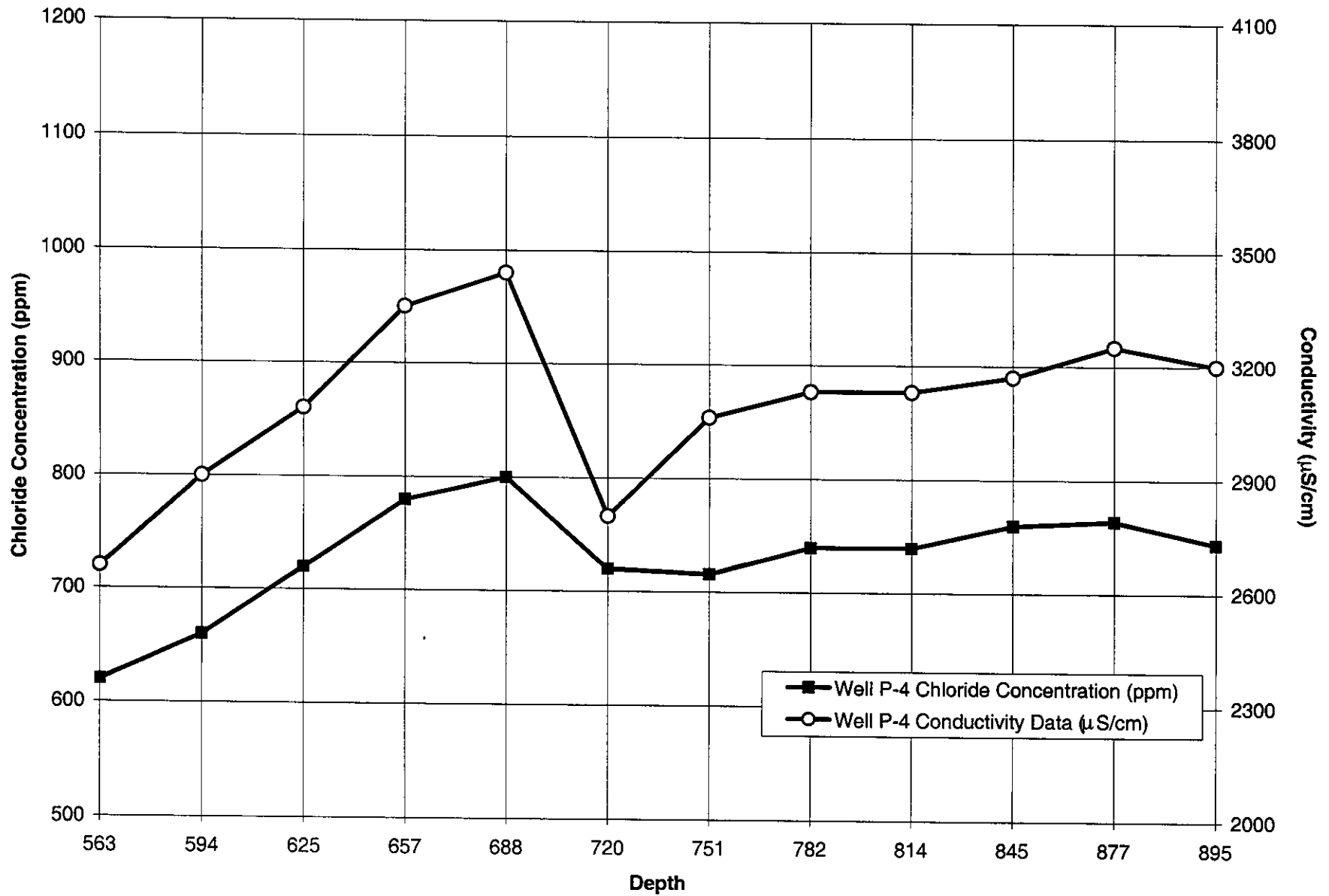

FIGURE 5-2
Well P-4 Pilot Hole Water Quality

5.3 Well P-5 Water Quality

The chloride concentration were noted to increase from 580 mg/L to 860 mg/L between 523 feet bls and 709 feet bls. The conductivity increased from 2,520 $\mu\text{S}/\text{cm}$ to 3,490 $\mu\text{S}/\text{cm}$ over this interval. Below 739 feet bls, the chloride concentration and conductivity stabilized and slightly decreased to the bottom of the pilot hole. The chloride concentration decreased from 860 mg/L to 810 mg/L while the conductivity decreased from 3,650 $\mu\text{S}/\text{cm}$ to 3,480 $\mu\text{S}/\text{cm}$. Figure 5-3 and Table 5-3 present a summary of pilot hole water sample results for well P-5.

TABLE 5-3
Well P-5 Pilot Hole Water Quality Results
City of Fort Myers WTP – Well Completion Report (P-3 through P-7)

Depth (feet bls)	Conductivity ($\mu\text{mhos}/\text{cm}$)	Chloride (mg/L)
523	2,520	580
554	2,740	660
585	2,800	700
616	3,070	760
647	3,230	790
677	3,400	810
709	3,490	860
739	3,650	840
770	3,550	860
801	3,520	840
832	3,480	810

5.4 Well P-6 Water Quality

From that data collected, the water quality in well P-6 was relatively consistent over the entire borehole. The chloride concentration of the pilot hole water samples ranged from 830 mg/L to 880 mg/L. The conductivity was also consistent, ranging from 2,930 $\mu\text{S}/\text{cm}$ to 3,410 $\mu\text{S}/\text{cm}$. Figure 5-4 and Table 5-4 present a summary of pilot hole water sample results for well P-6.

TABLE 5-4
Well P-6 Pilot Hole Water Quality Results
City of Fort Myers WTP – Well Completion Report (P-3 through P-7)

Depth (feet bls)	Conductivity ($\mu\text{mhos}/\text{cm}$)	Chloride (mg/L)
492	2,930	830
524	3,080	840
556	3,160	850
587	3,260	880
619	3,250	870
650	3,280	880
681	3,200	880
712	3,380	850
743	3,340	860
774	3,410	850
805	3,320	850

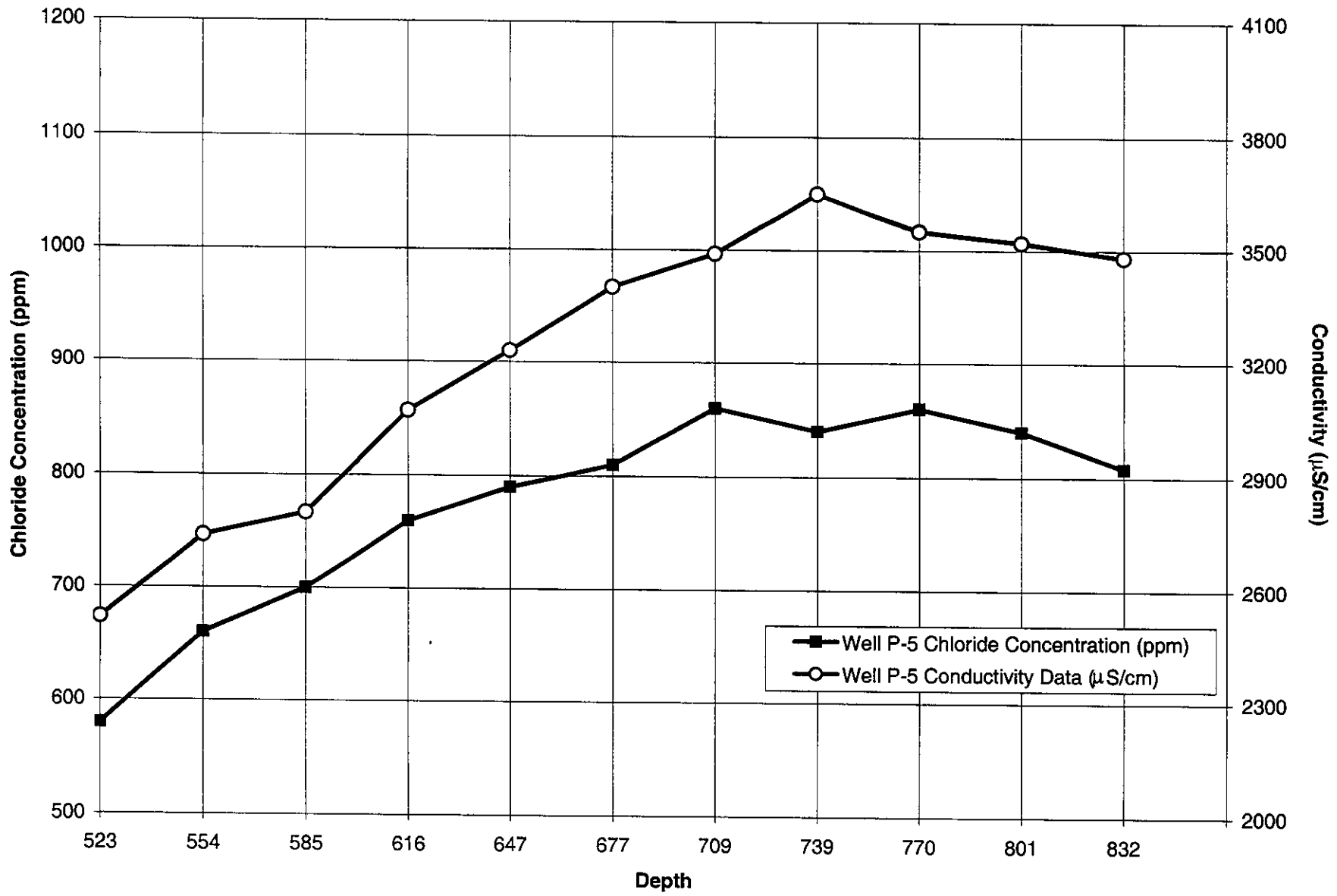

FIGURE 5-3
Well P-5 Pilot Hole Water Quality

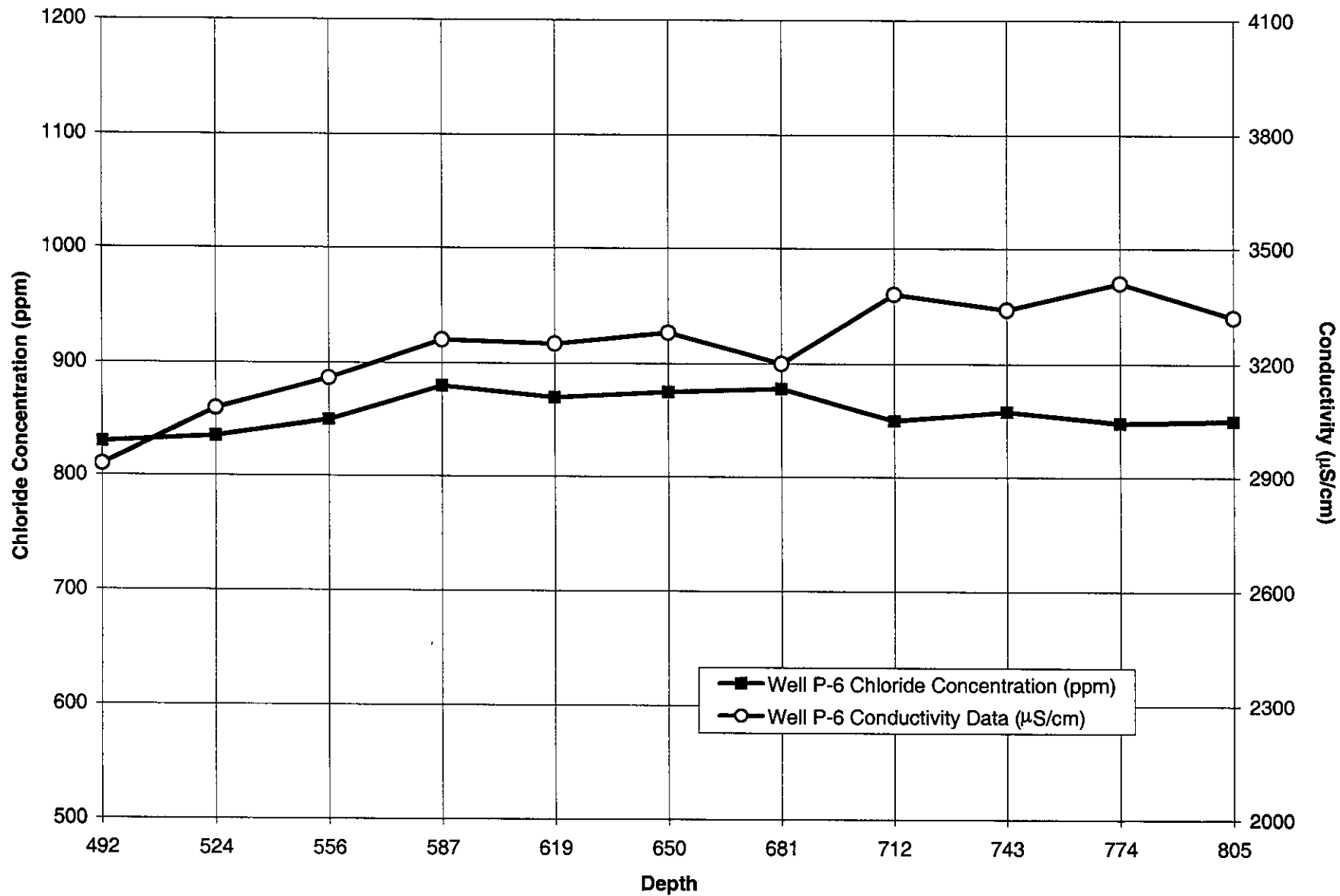

FIGURE 5-4
Well P-6 Pilot Hole Water Quality

5.5 Well P-7 Water Quality

Water quality results showed that the chloride concentration and conductivity were generally constant between 475 feet bls and the bottom of the pilot hole at 800 feet bls. The chlorides ranged from 930 mg/L to 1,050 mg/L over the entire depth of the well. Conductivity ranged from 3,390 μ S/cm to 3,700 μ S/cm. Figure 5-5 and Table 5-5 present a summary of pilot hole water sample results for well P-7.

TABLE 5-5
Well P-7 Pilot Hole Water Quality Results
City of Fort Myers WTP – Well Completion Report (P-3 through P-7)

Depth (feet bls)	Conductivity (μ hos/cm)	Chloride (mg/L)
475	3,390	990
502	3,510	1,050
535	3,450	1,040
566	3,490	950
597	3,440	930
629	3,470	960
659	3,390	1,000
690	3,700	950
720	3,630	980
752	3,630	1,000
782	3,520	960
800	3,490	940

5.6 Ambient Water Quality Results

Following each well acidization and pumping test for wells P-3 through P-7, water samples were collected and analyzed for complete primary and secondary drinking water standards. No exceedences of any anthropogenic parameters were noted in the results from any of the wells. Some key water quality parameters and their reported values are listed in Table 5-6. Copies of the complete water quality are provided in Appendix J.

5.7 Wellhead Bacteriological Analysis Results

After the wells were completed and the temporary wellheads were installed, bacteriological sampling was conducted. The samples were collected through a port in the wellheads under naturally flowing conditions. All of the analysis reported coliform to be absent with one exception in well P-4. This sample was reanalyzed for fecal coliform which was found to be absent. All of the bacteriological analysis reports are provided in Appendix K.

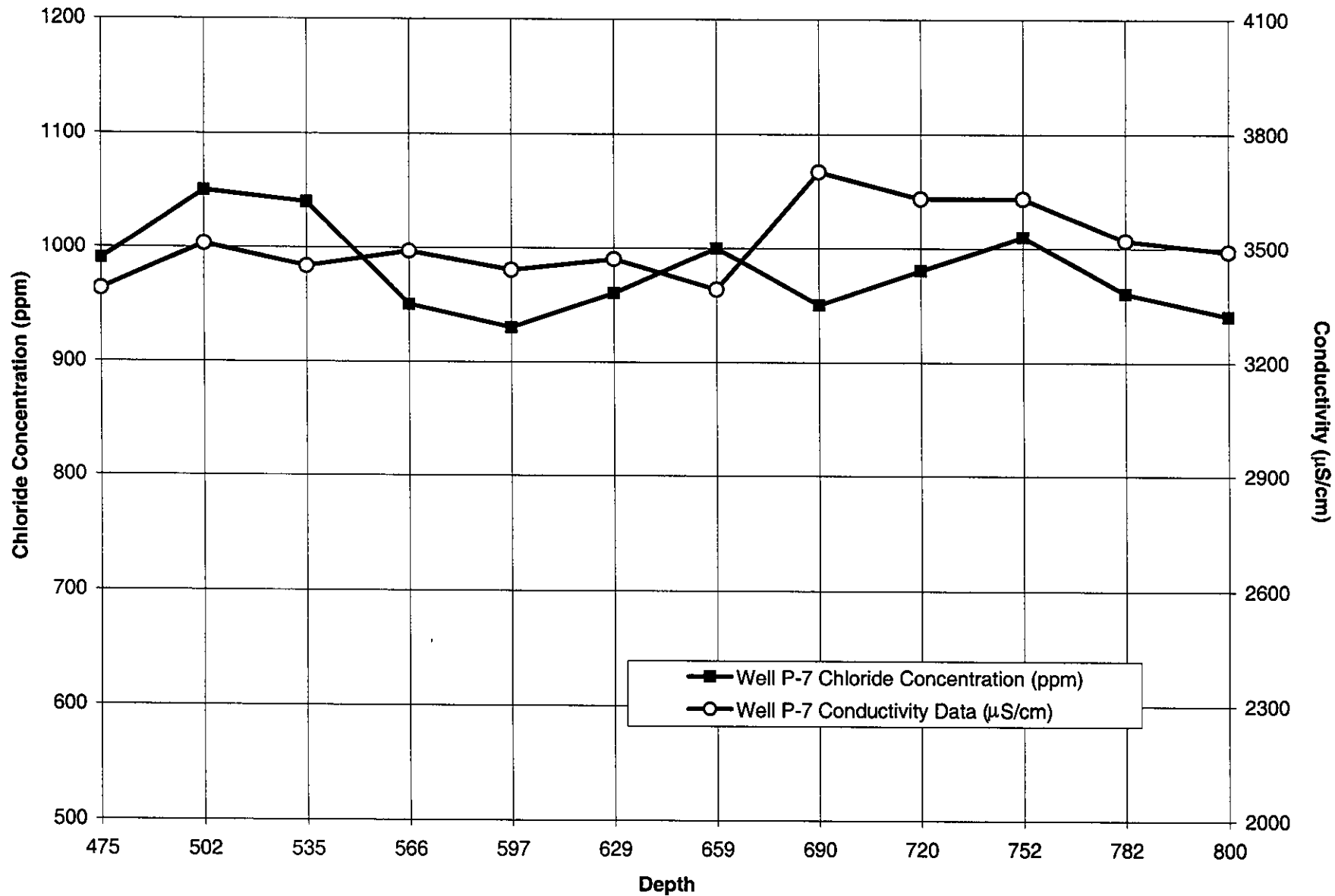

FIGURE 5-5
Well P-7 Pilot Hole Water Quality

TABLE 5-6

Final Water Quality Results Summary

City of Fort Myers WTP – Well Completion Report (P-3 through P-7)

Parameter	MCL ¹	Well P-1	Well P-2	Well P-3	Well P-4	Well P-5	Well P-6	Well P-7
Total Dissolved Solids (ppm)	500	1620	2140	2200	1900	2000	2100	2200
Chloride (ppm)	250	680	950	910	920	880	780	940
Sodium (ppm)	160	350	470	480	400	410	440	430
Conductance (umhos/cm)	NA	2790	3990	3770	3180	3530	3500	3640
Turbidity (NTU)	NA	NA	0.52	NA	NA	NA	NA	NA
Fluoride (ppm)	4	1.72	1.29	1.6	1.6	1.6	1.6	1.6
Color (PCU)	15	5	2.5	<5	<5	<5	<5	<5
pH	6.5-8.5	7.13	7.44	7.45	7.34	7.31	7.55	7.4
Iron (ppm)	0.3	0.041	<0.04	<0.04	<0.04	<0.04	<0.04	<0.40
Sulfate(ppm)	250	366	315	350	380	320	300	370
Arsenic (ppm)	0.050	<0.0022	<0.003	<0.005	<0.005	<0.005	<0.005	<0.005
Lead (ppm)	0.015	<0.001	<0.002	<0.001	<0.002	<0.002	<0.002	0.0012
Gross Alpha (pCi/L)	15	8.4 +/- 4.6	<3.0 +/- 0.72	12.7 +/- 2.9	9.4+/-3.4	9.2 +/- 3.7	6.8 +/- 2.8	6.0 +/- 3.8
Radium 226 (pCi/L)	5	2.9 +/- 0.4	7.02 +/- 1.19	9.9 +/- 0.5	5.5 +/- 0.4	NA	5.8 +/- 0.3	4.2 +/- 0.3
Radium 228 (pCi/L)		<0.7 +/- 0.4	0.14 +/- 0.77	2.0 +/- 0.06	1.0 +/- 0.6	NA	0.9 +/- 0.6	1.0 +/- 0.7

Notes:

1. Maximum Contaminant Level (MCL) per Rules 62-550.310, FAC.

2. Concentrations expressed in milligrams/liter (mg/L or ppm) unless otherwise indicated.

3. Abbreviations:

pCi/L: Picocuries/liter

NTU: Nephelometric Turbidity Unit

ppm: parts per million

umhos/cm: micro mhos per centimeter

PCU: Platinum Cobalt Units

NA: Not Available

4. The MCL for Radium 226 and Radium 228 combined is 5pCi/L

Section 6 Well Acidization



Well Acidization

Following the construction of the wells, each well was acidized to increase the performance and reduce the turbidity of the well. The acidization procedure consisted of injecting strong, 32 percent Hydrochloric acid (HCl) into the well, allowing it time to react with the formation, and then pumping the spent acid (salts) out of the well. Details of the acidization of wells P-2 through P-7 are presented below.

6.1 Well P-2 Acidization

Well P-2 was acidized with 4,000 gallons of 32 percent HCl on August 2, 2000. The acid was injected at a depth of 637 feet bls at approximately 100 gpm. Fresh water was also injected at the wellhead at a rate of 70 gpm during the acidization at the wellhead.

Immediately following acidization, approximately 4,000 gallons of fresh water (one casing volume) was also injected at 130 gpm into the well to force the acid into the formation. The well was immediately sealed and approximately 24 hours later 12,000 gallons of spent acid (salt water) was pumped into tanker trucks and removed from the site. The well was then opened and allowed to flow until the chloride concentration in the well decreased to 1,050 mg/L (within 10 percent of the preacidization level). Well P-2 was developed at rates up to 3,250 gpm on September 18 and September 19, 2000 for a total of 11 hours. The final specific capacity of P-2 was 110 gpm/ft while pumping at 3,225 gpm.

6.2 Well P-3 Acidization

Well P-3 was acidized with 3,000 gallons of 32 percent HCl on October 3, 2000. The acid was injected at a depth of 543 feet bls at approximately 100 gpm. Fresh water was also injected at the wellhead at a rate of 70 gpm during the acidization and immediately following acidization, 2,500 gallons of fresh water was injected at 92 gpm into the well to force the acid into the formation. The well was immediately sealed and at approximately 24 hours later, 12,000 gallons of spent acid (salt water) was pumped into tanker trucks and removed from the site. The well was then opened and allowed to flow until the chloride concentration in the well was reduced to 890 mg/L (within 10 percent of the preacidization level). Well P-3 was developed at rates up to 2,800 gpm on October 31 and November 1, 2000 for a total of 9 hours. Final specific capacity of well P-3 during the pumping test was 30 gpm/ft measured while pumping the well at 2,150 gpm.

6.3 Well P-4 Acidization

On October 10, 2000, well P-4 was acidized with 3,000 gallons of 32 percent HCl. The acid was injected at a depth of 606 feet bls at approximately 100 gpm. Fresh water was injected at a rate of 70 gpm during the acidization.

Following acidization, 3,000 gallons of fresh water was injected at 70 gpm into the well to force the acid into the formation. The well was then sealed for approximately 24 hours and 12,000 gallons of spent acid (salt water) was pumped into tanker trucks and removed from the site. The well was allowed to flow until the chloride concentration in the well decreased to 810 mg/L (within 10 percent of the preacidization level). Well P-4 was developed at rates up to 2,700 gpm on November 7 and November 8, 2000 for a total of 8 hours. Final specific capacity of well P-4 during the pumping test was 25 gpm/ft measured while pumping the well at 2,400 gpm. After the well had recovered to static conditions following development, the well was pumped at the design capacity of 1,400 gpm. Final specific capacity of P-4 was 35 gpm/ft at a pumping rate of 1,400 gpm.

6.4 Well P-5 Acidization

On September 27, 2000, well P-5 was acidized using 3,000 gallons of 32 percent HCL. The acid was injected at a depth of 543 feet bls at approximately 100 gpm. Fresh water was injected at an average rate of 60 gpm during the acidization.

Immediately following acidization, approximately 3,800 gallons of fresh water was injected at 38 gpm. The well was immediately sealed and allowed to remain undisturbed for approximately 24 hours after which approximately 12,000 gallons of spent acid (salt water) was pumped into tanker trucks and removed from the site. The well was then opened and allow to flow until the chloride concentration in the well was reduced to within 10 percent of the preacidization level (930 mg/L). Well P-5 was developed at rates up to 3,100 gpm on November 14 and November 15, 2000 for a total of 10 hours. Final specific capacity of P-5 was 34 gpm/ft during the pumping test at a discharge rate of 2,800 gpm.

6.5 Well P-6 Acidization

Well P-6 was acidized with 2,484 gallons of 32 percent HCl on October 6, 2000. The acid was injected at a depth of 465 feet bls at approximately 100 gpm. Fresh water was injected at a rate of 70 gpm. The acid injection was paused after approximately 1,200 gallons of HCl was placed in the well when the wellhead pressure increased from approximately 5 psi to 27 psi. Approximately 300 gallons of water was pumped into the well to stabilize the pressure buildup. When the acid injection resumed, an additional 700 gallons of HCl was pumped. As the acid was being injected, the wellhead pressure exceeded 30 psi and continued to rise to 71 psi. The acid injection was again paused and approximately 1,500 gallons of water was pumped into the well. When the wellhead pressure was reduced to 20 psi, approximately 600 gallons of acid was pumped into the well, however, the pressure rapidly rose above 50 psi, and a maximum pressure of 71 psi was observed. Because of high wellhead pressures, the acidization was discontinued and 2,300 gallons of fresh water was injected into the well force the acid into the formation and to slow the reaction. The well was immediately sealed and after approximately 24 hours, 12,000 gallons of spent acid (salt water) was pumped into tanker trucks and removed from the site. The well was then opened and allowed to flow until the chloride concentration was reduced to within 10 percent of the preacidization level (915 mg/L). Well P-6 was developed at rates up to 3,100 gpm on October 12 and 13, 2000 for a total of 6 hours. Final specific capacity of P-6 was 35 gpm/ft during the pumping test at a discharge rate of 2,300 gpm. After the well had recovered to static conditions following

development, the well was pumped at the design capacity of 1,400 gpm. Final specific capacity of P-6 was 50 gpm/ft at 1,400 gpm.

6.6 Well P-7 Acidization

Well P-7 was acidized with 3,000 gallons of 32 percent HCl on September 26, 2000. The acid was injected at a depth of 480 feet bls at approximately 100 gpm. Fresh water was injected at the top of the well at 55 gpm during the acidization. Immediately following acidization, 3,000 gallons of fresh water was injected at 75 gpm into the well to force the acid into the formation. The well was immediately sealed and after approximately 24 hours, 12,000 gallons of spent acid (salt water) was pumped into tanker trucks and removed from the site. The well was then opened and allowed to flow until the chloride concentration in the well was reduced to 950 mg/L, within 10 percent of the preacidization level. Well P-7 was developed at rates up to 3,250 gpm on October 24, 2000 for a total of 3 hours. Final specific capacity of P-7 was 43 gpm/ft during the pumping test at a discharge rate of 2,300 gpm.

Section 7 Groundwater Modeling



Groundwater Modeling

7.1 Background Information – Original Model

Following the construction of wells P-1 and P-2, CH2M HILL developed groundwater flow and solute transport models and conducted simulations for the City of Fort Myers artesian aquifer wellfield. Model development details are described in *Technical Memorandum No. 3, Fort Myers Artesian Aquifer Wellfield – Groundwater Model: Flow and Solute Transport*, dated August 1999. The U.S. Geological Survey's Modular Three-Dimensional Finite Difference Groundwater Flow Model (MODFLOW) was used to simulate long-term, steady-state aquifer response to pumping conditions. Predictive simulations indicated that continuous pumpage of the wellfield at 15.6 mgd average daily flow (ADF) would not present significant adverse impact to existing groundwater users. Drawdowns in the pumped aquifer are approximately 1 foot or less near other major pumping areas such as Cape Coral and Sanibel.

From the previous solute transport model simulations, total dissolved solids (TDS) may increase from background concentrations of 2,500 mg/L to approximately 3,000 mg/L in areas outside the wellfield, and up to 4,500 mg/L above background within the wellfield. This indicated that users should not experience adverse water quality impacts as a result of the proposed pumpage from the City's wellfield. The solute transport model could not be properly calibrated, therefore, it was mainly used as a model to compare different wellfield layouts than to predict future water quality changes.

The MODFLOW model simulated a 5-layer geologic system covering a regional area of 900 square miles. All of the City's proposed deep wells were simulated to withdraw from Layer 3 of the model. Aquifer parameters in the original groundwater flow and solute transport model were derived from onsite testing and were supplemented with aquifer characteristics from published reports. A uniform transmissivity value of 17,000 squared feet per day (ft^2/d) or 127,160 gallons per day per foot (gpd/ft) was used in Layer 3 of the original model based on well P-2 testing. The construction of the 5 new production wells (P-3 through P-7) provided additional hydrogeologic data which suggests that the transmissivity ranges 8,045 ft^2/d [60,176 gpd/ft] to 21,260 ft^2/d [149,600 gpd/ft] in the area of the new production wells. These new data allowed the existing groundwater flow model parameters to be updated and the model to be re-calibrated to better represent local variances in hydrogeology within the expanded wellfield.

7.2 Numerical Model Calibration – Wells P-1 through P-7

To improve performance of original model, extensive testing was completed on the 5 new wells and the results were used to calibrate the groundwater flow model. Estimated hydrogeologic parameters were assigned based on the analysis of aquifer performance, These tests used water levels observed in wells closest to the pumped well(s), and the

results of the test were used to verify model performance. The existing MODFLOW model was updated by calibrating to the observed results of pumping tests conducted on wells P-5 and P-4. From the aquifer testing, the production zone at wells P-1 and P-3 was found to have a lower transmissivity, less than 10,000 ft²/d (approximately 75,000 gpd/ft), than that at the other production wells which were above 20,000 ft²/d (approximately 150,000 gpd/ft). Calibration to the 24-hour pumping test conducted on well P-4 indicated an aquifer transmissivity of 8,490 ft²/day (63,500 gpd/ft) using P-3 as the drawdown observation point located approximately 1,240 feet away from well P-4. The calibration curve showing simulated and observed data from well P-3 is shown in Figure 7-1.

The results from the well P-5 pumping test indicate aquifer transmissivities for wells P-5, P-6, and P-7 to be similar to those found during the testing of well P-2. The monitoring data from well P-6 (located approximately 1,050 feet away) obtained during the 5-day P-5 pumping test were used to determine a representative transmissivity for this area. Well P-4 drawdown data was not used in conjunction with well P-6 data for calibration purposes because it is located approximately 1,460 feet away from well P-5 and there was more confidence in the validity of the well P-6 observed drawdowns. Calibration to the 5-day pumping test conducted on well P-5 indicated an average aquifer transmissivity of 16,090 ft²/day (120,350 gpd/ft) using P-6 as the drawdown observation point located approximately 1,050 feet away from well P-5. The calibration curve showing the simulated and the observed data from well P-6 is shown in Figure 7-2.

The previously documented model was modified to incorporate the new well locations and the variable transmissivities estimated from the pumping tests. The model grid was modified with refined grid lines around the wells to properly estimate the drawdowns near each well, as seen in Figure 7-3. The final calibrated transmissivity distribution for Layer 3 is divided into four regions. Layer 3 transmissivities vary from north to south. Values range from 14,500 ft²/day (108,460 gpd/ft) near P-2, 10,500 ft²/day (78,540 gpd/ft) near P-1 and P-3, 14,500 ft²/day (108,460 gpd/ft) near P-4, and 18,500 ft²/day (138,380 gpd/ft) near P-5, P-6, and P-7. This distribution provided the best aquifer response match based on the data available from the pumping tests. The Layer 3 transmissivity distribution is represented in Figure 7-4. A storativity value of 1×10^{-4} and a leakance value of $5 \times 10^{-4} \text{ d}^{-1}$ were used consistently throughout Layer 3. The transmissivity was estimated to be lower than 10,500 ft²/day (78,540 gpd/ft) from the aquifer tests near P-1 and P-3, however the above combination of transmissivity, storativity, and leakance proved to be the best match of observed drawdowns in the tested wells. Table 7-1 compares the aquifer test results with the numerical model transmissivity distribution. Since the transmissivity was estimated only in an adjacent non-pumping production well and not in the pumping well itself, the transmissivity distribution was based on the location of the monitored non-pumping well. In the case of P-4, the transmissivity was estimated to be 8,045 ft²/day (60,170 gpd/ft), and 15,060 ft²/day (112,660 gpd/ft) from pumping tests at P-3 and P-5, respectively. Since the transmissivity apparently increases towards the south in the direction of P-5, P-6, and P-7, the higher transmissivity in the area of P-4 is consistent with this trend.

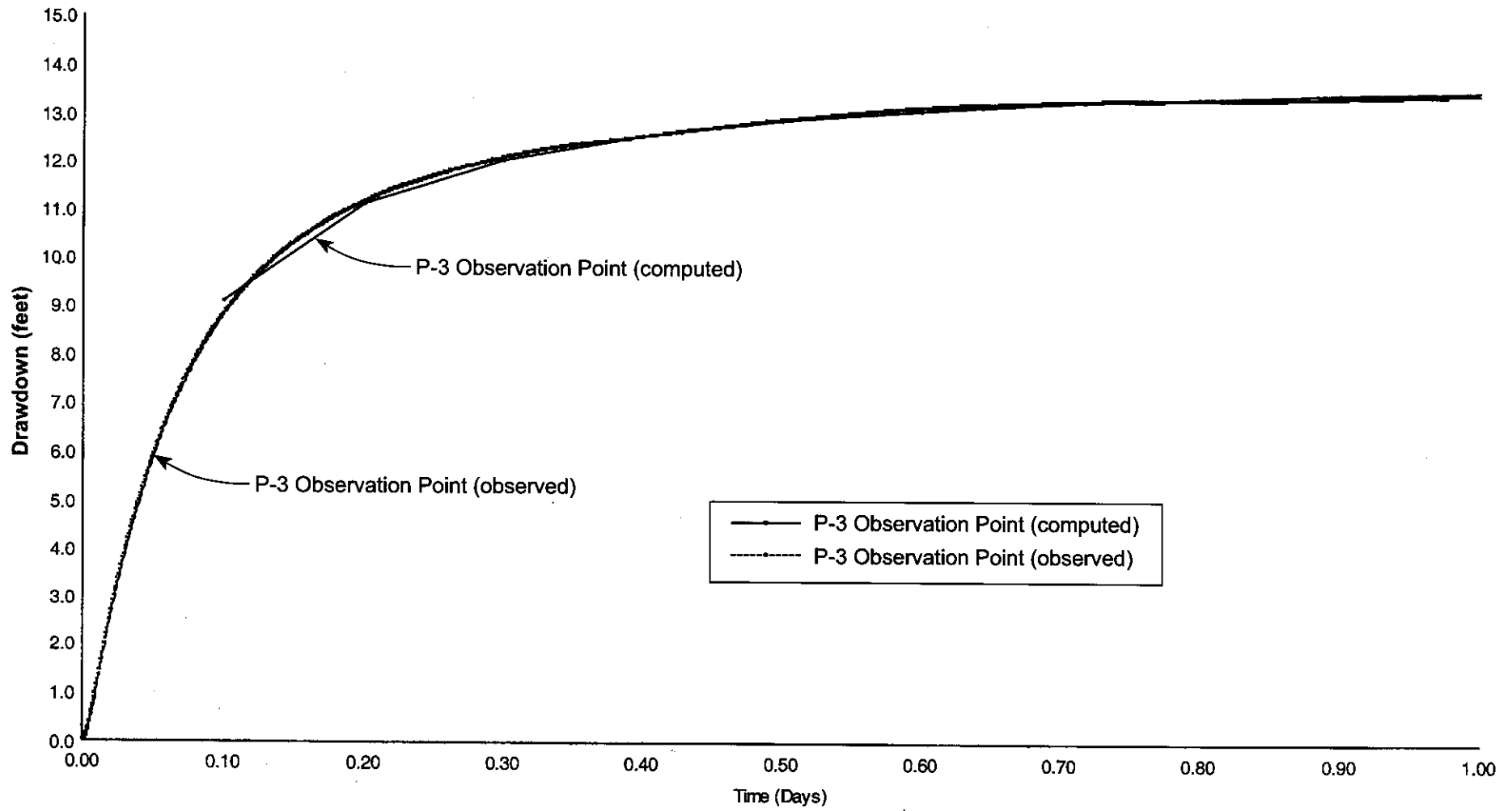

FIGURE 7-1

Model Calibration Results of P-3 Observed Data from the P-4 Pump Test

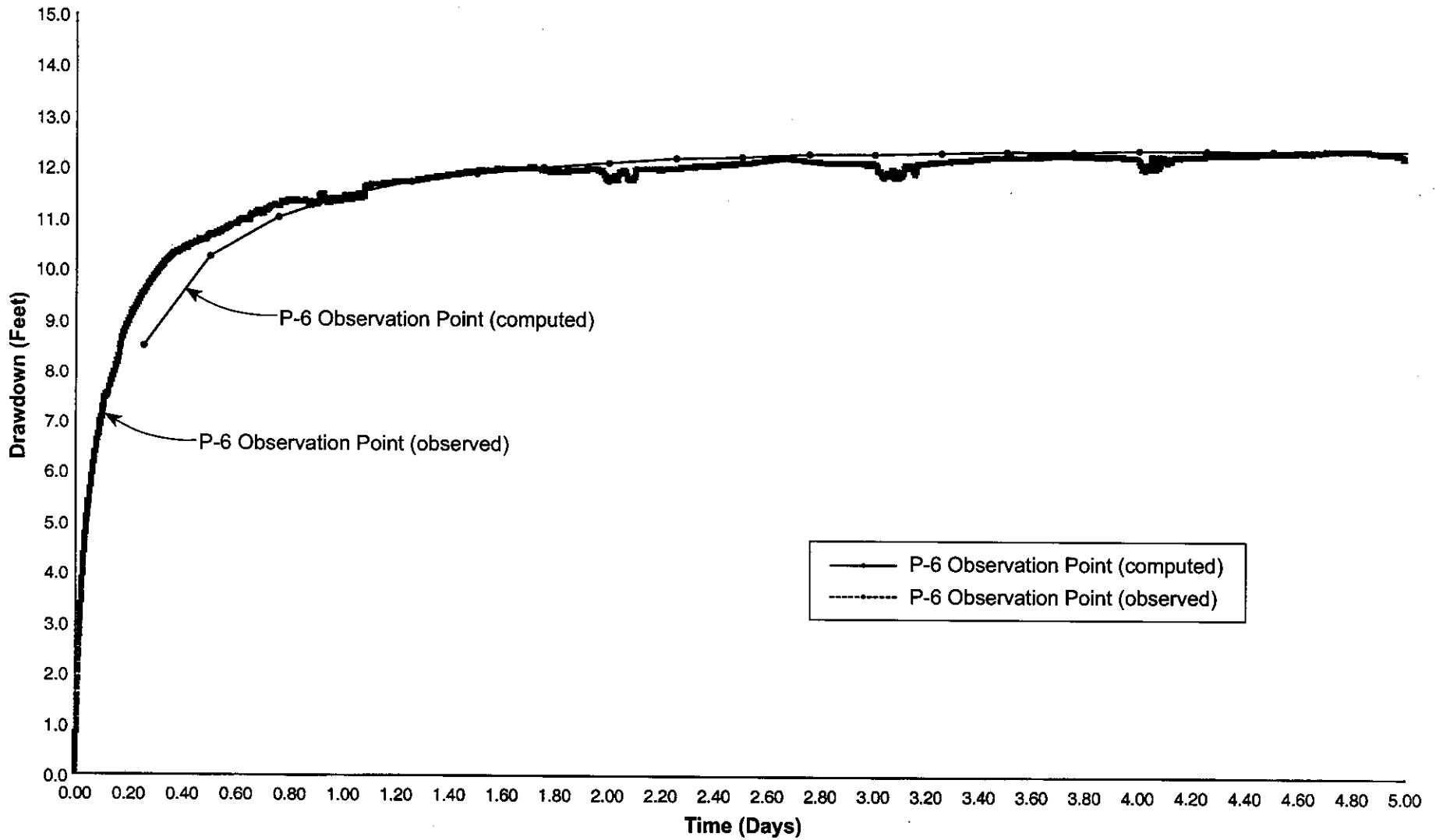
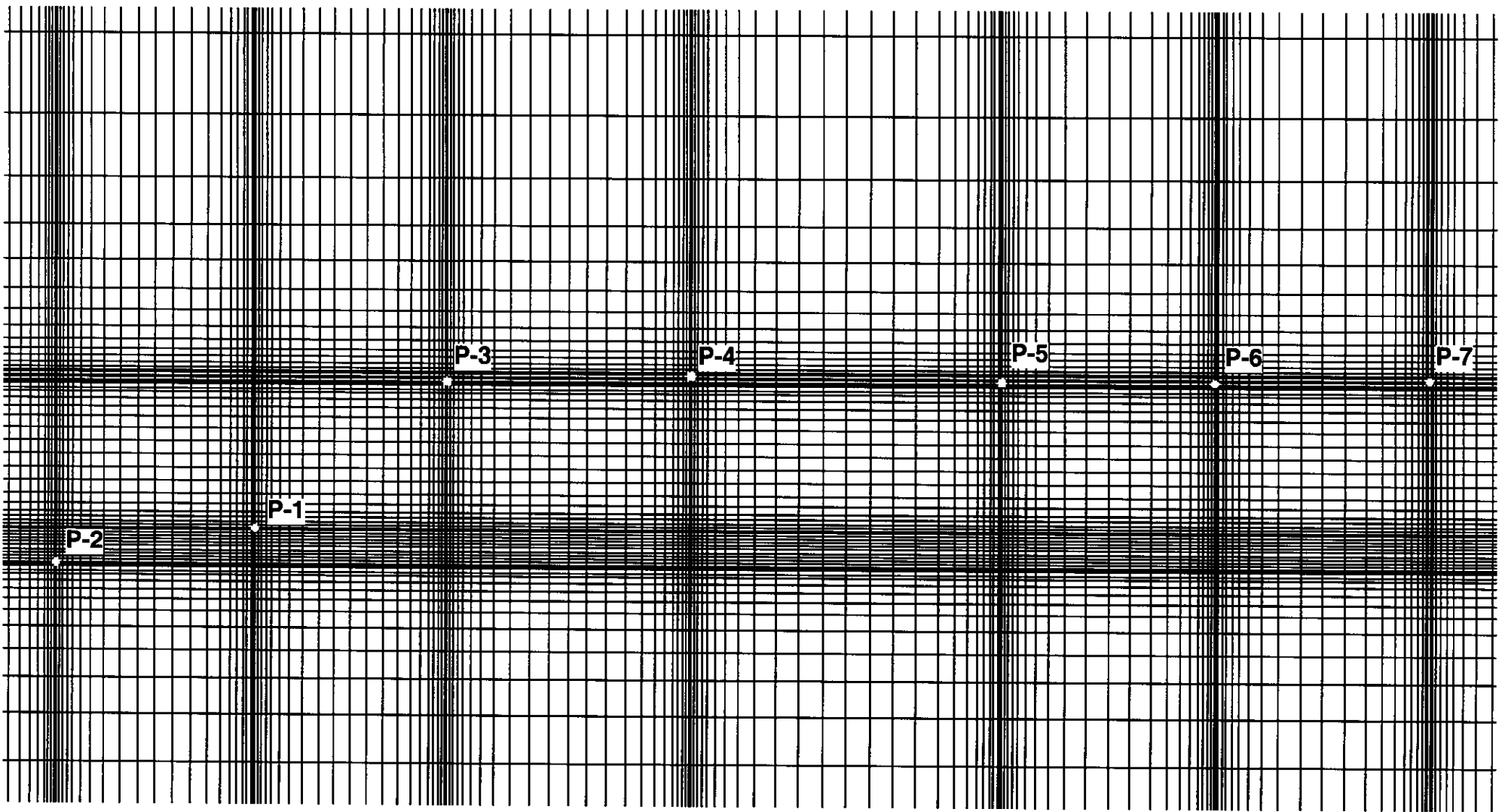

FIGURE 7-2

Model Calibration Results of P-6 Observed Data from the P-5 Pumping Test



*NOTE:
This figure is a close-up of the well placement and gridline
refinement. The entire grid dimension is 30 miles square.*

FIGURE 7-3

Refined Grid Spacing for the Numerical Model Simulations

$$\begin{aligned} T &= 14500 \text{ ft}^2/\text{D} \\ S &= 1 \times 10^{-4} \\ L &= 5 \times 10^{-4} \text{ D}^{-1} \end{aligned}$$

● P-2

● P-1

$$\begin{aligned} T &= 10500 \text{ ft}^2/\text{D} \\ S &= 1 \times 10^{-4} \\ L &= 5 \times 10^{-4} \text{ D}^{-1} \end{aligned}$$

● P-3

$$\begin{aligned} T &= 14500 \text{ ft}^2/\text{D} \\ S &= 1 \times 10^{-4} \\ L &= 5 \times 10^{-4} \text{ D}^{-1} \end{aligned}$$

● P-4

● P-5

$$\begin{aligned} T &= 18500 \text{ ft}^2/\text{D} \\ S &= 1 \times 10^{-4} \\ L &= 5 \times 10^{-4} \text{ D}^{-1} \end{aligned}$$

● P-6

● P-7

TABLE 7-1
 Comparison of Aquifer Test Results with Model Transmissivity Distribution
 City of Fort Myers WTP – Well Completion Report (P-3 through P-7)

Estimated Aquifer Parameters from Testing				Model Transmissivity Distribution		
Pumped Well Name	Observed Well Name	Aquifer Test Average Transmissivity (ft ² /d)	Aquifer Test Average Transmissivity (gpd/ft)	Well Name	Layer 3 Model Transmissivity at Well (ft ² /d)	Layer 3 Model Transmissivity at Well (gpd/ft)
P-1	P-2	14,540	108,760	P-1	10,500	78,540
P-2	P-1	9,000	67,000	P-2	14,500	108,460
P-3	P-4	8,045	60,180	P-3	10,500	78,540
P-4	P-3	8,490	63,500	P-4	14,500	108,460
P-5	P-4	15,060	112,650	P-5	18,500	138,400
P-6	P-7	21,260	159,000	P-6	18,500	138,400
P-7	P-6	21,170	158,350	P-7	18,500	138,400

7.3 Semi-Analytical Model Calibration

Upon the completion of the calibration of the numerical model, a commercial semi-analytical model, *AQUIFERWIN32*, was used to provide a conservative calculation of drawdown based on the lowest transmissivity in the numerical model of 10,500 ft²/d as used in the vicinity of wells P-1 and P-3. This analytical model assumes steady state conditions and aquifer homogeneity, using average aquifer parameters for the simulated aquifer. The calibration check was accomplished by using the estimated transmissivity determined from the pumping test conducted on well P-3. This transmissivity in the area of well P-1 was also used in the three-dimensional model. The semi-analytical model drawdown data from a simulation with all of the wells pumping was also used to establish a general pump setting depth for all of the well pumps because the well P-1 predicted drawdown is the greatest due to the low transmissivity, of 10,500 ft²/d (78,540 gpd/ft), and due to well interference drawdowns from the adjacent pumping wells. A storativity value of 1x10⁻⁴ and a leakance value of 2x 10⁻⁴ d⁻¹ were used in the analytical simulation.

7.4 MODFLOW Simulated Aquifer Response

Once the MODFLOW calibration was completed, wellfield impacts were simulated assuming three long-term pumping scenarios. The three scenarios used to estimate the regional effects with seven wells pumping include:

- Scenario 1 - Anticipated daily operational rate of 1.3 million gallons per day (mgd) [approximately 900 gpm] for 90 days (no recharge)
- Scenario 2 - Anticipated daily operational rate of 1.3 million gallons per day (mgd) [approximately 900 gpm] for 5 years (no recharge)

- Scenario 3 - Maximum design rate of 2.0 mgd (approximately 1,400 gpm) for 90 days (no recharge)

These pumping scenarios are based on the capacities of the recently completed wells and the design capacity of the WTP. The three scenario result summaries are provided in Table 7-2 and are described below.

7.4.1 Scenario 1 – Seven Wells Pumping 1.3 mgd Each for 90 Days

This scenario simulated a total groundwater withdrawal of 9.1 mgd from the wellfield for a total period of 90 days. The simulated drawdowns of the potentiometric surface for this scenario are shown in Figure 7-5. Maximum drawdown was approximately 48 feet (approximately 36 feet below land surface) in Layer 3 (area immediately surrounding well P-1) and 1.9 feet in Layer 2. The 1-foot drawdown contour in Layer 3 extends approximately 6 miles from the center of the wellfield.

7.4.2 Scenario 2 – Seven Wells Pumping 2.0 mgd Each for 90 Days

This scenario simulated a total groundwater withdrawal of 14.0 mgd from the wellfield for a total period of 90 days. The drawdowns for this scenario are shown in Figure 7-6. Maximum drawdown was approximately 74 feet (approximately 62 feet bls) in Layer 3 (area immediately surrounding well P-1) and 3.0 feet in Layer 2. The 1-foot drawdown contour in Layer 3 extends approximately 7 miles from the center of the wellfield.

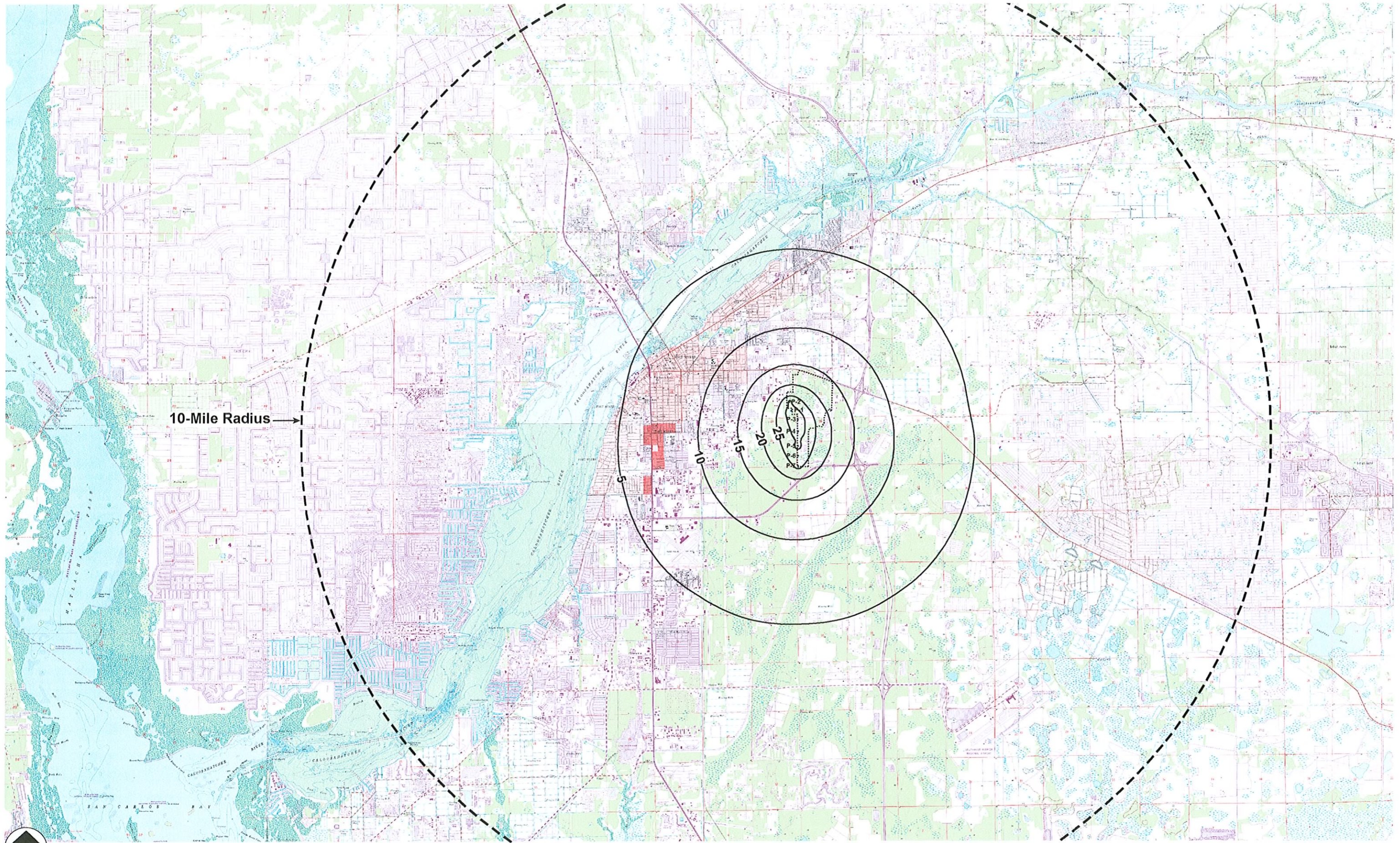

10-Mile Radius →

5

10

15

20

25



CH2MHILL

USGS Quads:
 Fort Myers, FL - 1987 Matlacha, FL - 1987
 Fort Myers NW, FL - 1987 Pine Island Center, FL - 1987
 Fort Myers SE, FL - 1987 Awa SW, FL - 1987
 Fort Myers SW, FL - 1987 Olga, FL - 1987

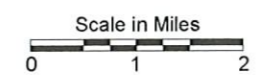
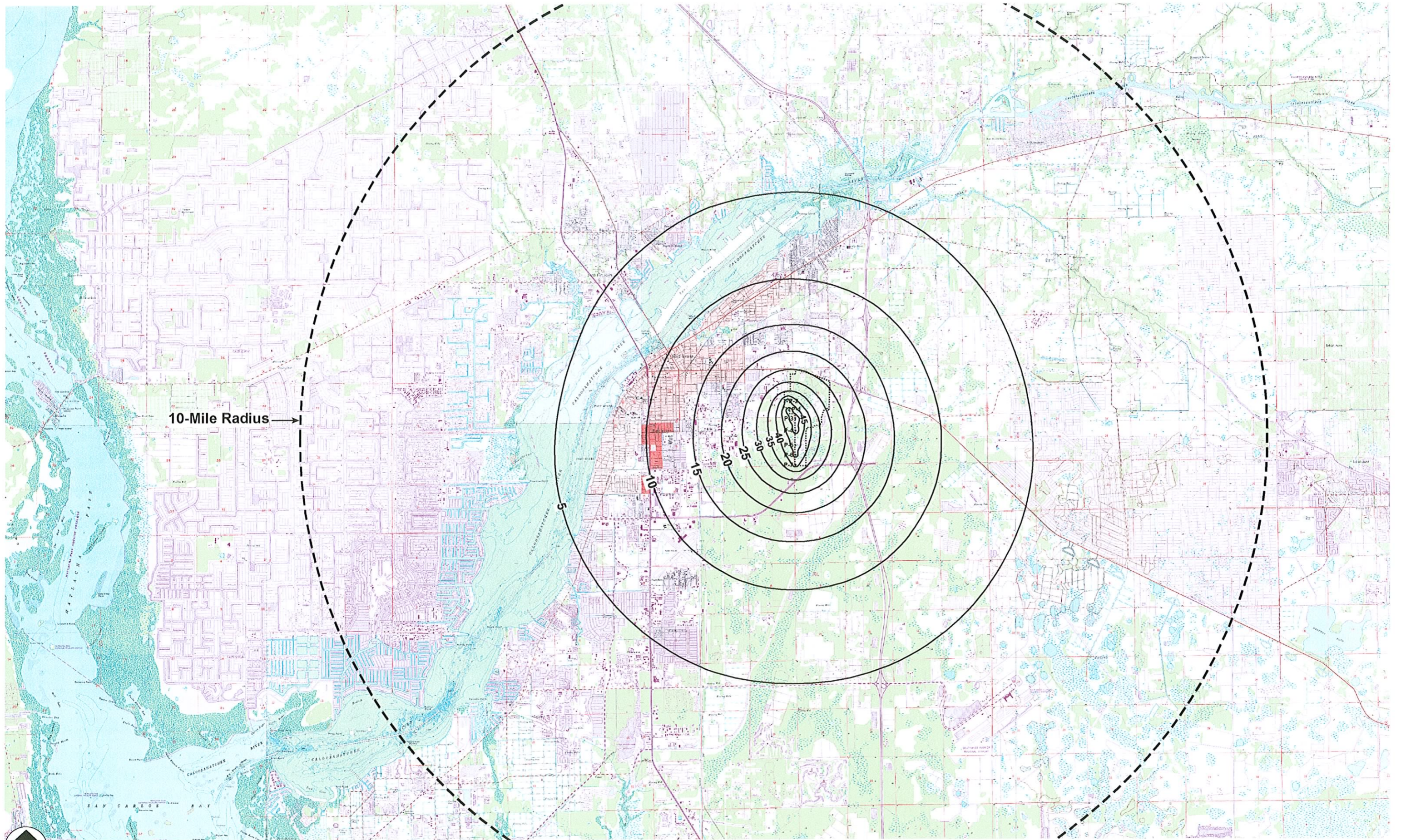

FIGURE 7-5
 Simulated Drawdown of Layer 3 for the 90-Day Withdrawal Scenario at 1.3 MGD per Well



10-Mile Radius →



CH2MHILL

USGS Quads:
 Fort Myers, FL - 1987 Matlacha, FL - 1987
 Fort Myers NW, FL - 1987 Pine Island Center, FL - 1987
 Fort Myers SE, FL - 1987 Awa SW, FL - 1987
 Fort Myers SW, FL - 1987 Olga, FL - 1987



FIGURE 7-6
 Simulated Drawdown of Layer 3 for the 90-Day Withdrawal Scenario at 2.0 MGD per Well

TABLE 7-2
MODFLOW Numerical Model Results
City of Fort Myers WTP – Well Completion Report (P-3 through P-7)

Simulation Name	Well Name	Layer 3 Drawdown in Well Cell (feet)	Maximum Drawdown Observed in Other Model Layers (feet)	
Scenario 1 90 days at 1.3 mgd per well	P-1	46	Layer 2	1.9
	P-2	38	Layer 4	7.0
	P-3	48	Layer 5	0.2
	P-4	43		
	P-5	38		
	P-6	36		
	P-7	34		
Scenario 2 90 days at 2.0 mgd per well	P-1	72	Layer 2	3.0
	P-2	60	Layer 4	10.9
	P-3	74	Layer 5	0.3
	P-4	66		
	P-5	59		
	P-6	56		
	P-7	52		
Scenario 3 5 years at 1.3 mgd per well	P-1	47	Layer 2	8.5
	P-2	39	Layer 4	7.3
	P-3	48	Layer 5	0.2
	P-4	43		
	P-5	38		
	P-6	37		
	P-7	34		

mgd – million gallons per day

7.4.3 Scenario 3 – Seven Wells Pumping 1.3 mgd Each for 5 Years (1825 Days)

Scenario 3 simulated a total groundwater withdrawal of 9.1 mgd from the wellfield for a total period of 5 years (1,825 days). The drawdowns for this scenario are shown in Figure 7-7. Maximum drawdown was approximately 48 feet (approximately 36 feet bls) in Layer 3 (area immediately surrounding well P-1) and 8.5 feet in Layer 2. The 1-foot drawdown contour in Layer 3 extends approximately 7 miles from the center of the wellfield.

7.5 AQUIFERWIN32 Simulated Aquifer Response

Once the MODFLOW model simulations were completed, the wellfield impacts were also simulated using the AQUIFERWIN semi-analytical program to estimate drawdowns in the individual wells. The general transmissivity used in the semi-analytical model incorporate the lowest transmissivity used in the numerical model. Two of the three scenarios mentioned above were repeated and the resulting calculated drawdowns are presented in Table 7-3. The two scenarios used to calculate drawdowns in each well if all seven of the wells were pumping are:

- Scenario 2 (as above) - Maximum design rate of 2.0 mgd for each well [approximately 1,400 gpm] for 90 days

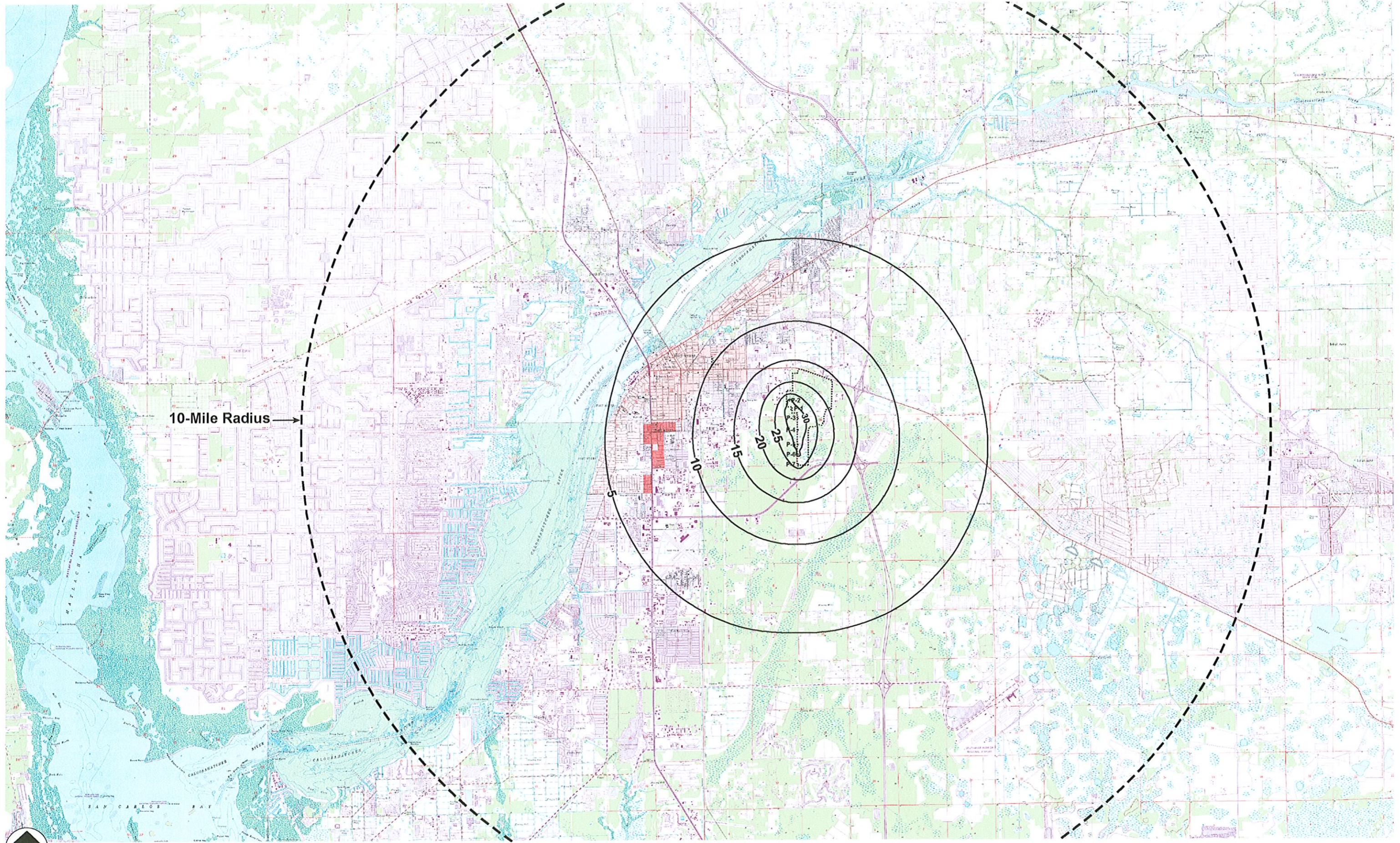

10-Mile Radius →



USGS Quads:
 Fort Myers, FL - 1987 Matlacha, FL - 1987
 Fort Myers NW, FL - 1987 Pine Island Center, FL - 1987
 Fort Myers SE, FL - 1987 Alva SW, FL - 1987
 Fort Myers SW, FL - 1987 Olga, FL - 1987



FIGURE 7-7
 Simulated Drawdown of Layer 3 for the 5-year Withdrawal Scenario at 1.3 MGD per Well

- Scenario 3 (as above) - Anticipated daily operational rate of 1.3 mgd for each well [approximately 900 gpm] for 5 years

These pumping scenarios are based on the capacities of the recently completed wells and the design capacity of the WTP, as mentioned previously. The lowest transmissivity value that was used for the numerical model simulation, 10,500 ft²/d (78,540 gpd/ft), was used to assess the worst case drawdown impacts to be expected in the wellfield with all of the wells pumping. This model also calculates the drawdown from well interference. The storativity value of 1x10⁻⁴ and a leakance value of 2x10⁻⁴ d⁻¹ were used for both scenarios. The results show that the maximum drawdown was 67 feet in P-4 for the 90-day scenario, and 43 feet in P-4 for the 5-year scenario. Pumps are recommended to have a setting depth of 80 feet which is 86 percent greater than the 5-year drawdowns and 20 percent greater than 90-day drawdown scenario.

After the modeling was completed, the Theis equation was used to calculate the theoretical drawdown in the pumping well based on the drawdowns observed in the monitoring wells and transmissivities calculated from the aquifer performance tests which were conducted on each well. The differences between the observed drawdowns in the production wells and the theoretical drawdowns based on the analytical equation can be attributed to formation losses which is related to poorly connected secondary porosity in limestones. Table 7-3 adds these losses to the modeled drawdowns for each well in the two model scenarios.

TABLE 7-3
AQUIFERWIN Analytical Model Results
City of Fort Myers WTP – Well Completion Report (P-3 through P-7)

Simulation Name	Well Name	Modeled Drawdown (feet)	Modeled Drawdown Plus Formation Losses (feet)	Aquifer Parameters
Scenario 2 90 days at 2.0 mgd per well	P-1	65	65	T= 10,500 ft ² /d S= 1x10 ⁻⁴ L= 2x10 ⁻⁴ d ⁻¹ Q= 1,400 gpm
	P-2	59	69	
	P-3	66	66	
	P-4	67	78	
	P-5	66	78	
	P-6	64	85	
	P-7	58	71	
Scenario 3 5 Years at 1.3 mgd per well	P-1	42	42	T= 10,500 ft ² /d S= 1x10 ⁻⁴ L= 2x10 ⁻⁴ d ⁻¹ Q= 900 gpm
	P-2	39	45	
	P-3	43	43	
	P-4	43	50	
	P-5	43	51	
	P-6	42	55	
	P-7	38	46	

T= transmissivity
S= storativity
L= leakance
Q= discharge rate from each well

7.6 Modeling Results Summary

The numerical and analytical groundwater flow model simulations discussed above have been calibrated based on thorough testing following the recent construction of wells P-3 through P-7. The previous model framework was updated and calibrated to observed field

data with the addition of varying transmissivity values in aquifer Layer 3 to adequately describe varying aquifer properties observed in the field.

Three scenarios conducted with the numerical model provided insight to the wellfield impacts which might be expected. Two scenarios were run for individual well rates of 1.3 mgd, the anticipated average daily flow, to model short-term (Scenario 1 - 90 days) and long-term (Scenario 3 - 5 years) wellfield impacts. When the drawdowns for Scenario 1 is compared to Scenario 3, it is evident that the variances in the drawdowns are minimal. The primary difference between the scenarios is the amount of approximated drawdown in Layer 2. The scenarios suggest that long-term pumping will increase the amount of water supplied through leakance from Layer 2 above, causing maximum drawdowns in Layer 2 to increase from 1.9 feet after 90 days to 8.5 feet after 5 years.

Based on the groundwater flow model simulations, the proposed pumpage from the Lower Hawthorn Formation and upper Suwannee Limestone aquifer system from the City's new 14 mgd maximum day brackish aquifer wellfield should not present any adverse impacts to existing groundwater users. This finding is consistent with the previous investigation presented in CH2M HILL's Technical Memorandum No. 3.

Section 8 Summary and Recommendations



Summary and Recommendations

8.1 Summary

This report has been prepared to document the drilling, testing, and acidizations of the City of Fort Myers deep artesian aquifer production wells P-3, P-4, P-5, P-6, and P-7, the acidization of well existing well P-2, and the installation of a PVC liner in existing well P-1.

Construction of each well included two concentric casings, a 24 or 26-inch diameter steel surface casing set at approximately 100 feet bls and a final 16-inch diameter PVC casing set to depths ranging from 445 feet bls to 510 feet bls. The final completion depths ranged from 800 feet bls in well P-7 to 837 feet bls in well P-3.

The production zone of the all the wells is located in the lower portion of the Acardia Formation (Lower Hawthorn producing zone of the Intermediate Aquifer) and the Upper portion of the Suwannee Limestone of the Floridan Aquifer.

Wells P-2 through P-7 were acidized using with 32 percent HCl to increase the hydraulic conductivity and the well's production. Following acidization, the specific capacity of well P-2 increased from 38 gpm/ft to 110 gpm/ft. Wells P-3 through P-7 specific capacity at flow rates above 300 gpm increased from between 16 and 40 gpm/ft to between 35 and 50 gpm/ft.

Extensive hydrogeologic testing was conducted during construction of these wells. This testing included lithologic sampling, pilot hole water quality sampling, geophysical logging, air-lift specific capacity testing, pumping tests, and final water quality testing. The hydrogeologic testing focused on identifying the productive intervals with water quality compatible with reverse osmosis treatment technology. Aquifer transmissivity values ranged from 8,000 ft²/day (60,000 gpd/ft) to 21,000 ft²/day (157,000 gpd/ft). The average transmissivity value from analysis of pumping and recovery data was approximately 14,860 ft²/day (111,000 gpd/ft), however, transmissivity values vary throughout the wellfield.

8.2 Recommendations

Data obtained during the construction and testing of wells P-2 through P-7 confirm that the intercepted artesian aquifer systems of the Lower Hawthorn producing zone and upper portion of the Floridan Aquifer provide suitable water quality and productivity for wellfield development. It is recommended that the City of Fort Myers continue with conversion of the water treatment plant to reverse osmosis treatment.

All of the wells (P-1 through P-7) have been tested at rates of 2,100 gpm or more and are capable of producing at the maximum design rate of 1,400 gpm. Wells P-2 and P-7 are the most productive and should be used preferentially whenever possible.

It is recommended that the well pumps be located at 100 feet bls or deeper for all wells. During normal operation, the water level in the wells is expected to be approximately 60 feet bls. Therefore, the 100-foot setting depth should allow for some decline in well capacity and some lowering of the potentiometric head of the production zone. More competing use of this aquifer, however, will reduce the potentiometric head of this system and deeper pump settings (and higher head pumps) may be required in the future.

Static and dynamic pumping levels in the wells should be monitored and changes in specific capacity of the wells noted. Periodic acidization of the wells may be required to reduce depositions near the well bore and to reduce turbidity. Significant declines (greater than 30 percent) in specific capacity may indicate that acidization is required.

Water quality from each well should be monitored on a weekly basis during the first 6 months of wellfield start up. This sampling may be reduced following a review of the data. Parameters should include at a minimum chloride and specific conductivity.

Wellfield optimization modeling should be conducted following start up of the expanded wellfield. This modeling will aid in optimizing well pumpage rotation and flow rates of the new wellfield to minimize any possible adverse impacts. Further calibrations can also be made to the model to simulate the current wellfield operation which can be used to model additional wellfield expansions in the future.

Section 9 Bibliography and References

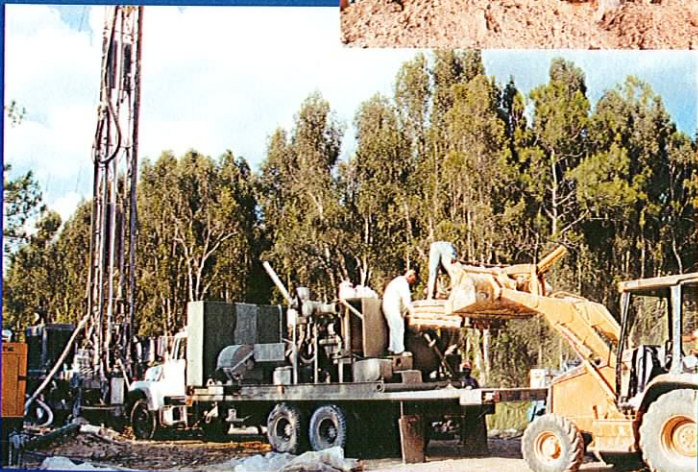

SECTION 9

Bibliography and References Cited

CH2M HILL, 1998. *Engineering Report on the Construction and Testing of Artesian Test Production Well TP-1, Fort Myers, Florida*. Prepared for the City of Fort Myers.

CH2M HILL, 1997. *Engineering Report On the Sources of Water Supply and its Water Treatment Requirements*. Prepared for the City of Fort Myers.

Cooper, H.H., Jr., 1963. *Type Curves for Non-Steady Radial Flow in an Infinite Leaky Artesian Aquifer*. USGS Water Supply Paper 1545-C, C48-C55.

Cooper, H.H., Jr., and Jacob, C.E., 1946. *A Generalized Graphical Method for Evaluating Formation Constants and Summarizing Well-Field History*. Transactions American Geophysical Union, Vol. 27, pp. 526-534.

Florida Department of Environmental Protection, FAC - 62-621.

Groundwater and Wells. 1975. Johnson Division, UOP Inc., St. Paul, Minnesota.

Hantush, M.S., 1956. *Analysis of Data From Pumping Tests in Leaky Aquifers*. Transactions American Geophysical Union, Vol. 371, pp. 702-714.

Hantush, M.S., 1964. *Hydraulics of Wells*. Advances in Hydrosiences.

Kruseman, G.P. and de Ridder, N.A., 1979. *Analysis and Evaluation of Pumping Test Data. Bulletin 11. International Institute for Land Reclamation and Improvement*. Wageningen, the Netherlands.

South Florida Water Management District, November 1984. Technical Publication 84-10, *Preliminary Water Resource Assessment of the Mid and Lower Hawthorn Aquifers in Western Lee, County, Florida*.

South Florida Water Management District, January 1982. Technical Publication 82-1, *Hydrogeologic Reconnaissance of Lee County, Florida*.

Theis, C. V. *The lowering of the Piezometric Surface and the Rate and Discharge of a Well Using Ground Water Storage*. Transactions, American Geophysical Union, 16 (1935): 519-24.

Appendices



APPENDIX A

Regulatory Permits



SOUTH FLORIDA WATER MANAGEMENT DISTRICT

3301 Gun Club Road, West Palm Beach, Florida 33406 • (561) 686-8800 • FL WATS 1-800-432-2045 • TDD (561) 697-2574
Mailing Address: P.O. Box 24680, West Palm Beach, FL 33416-4680 • www.sfwmd.gov

CON 24-06

May 09, 2000

PERMITTEE

CITY OF FORT MYERS
P.O. BOX 2217
FT. MYERS, FL 33902

CONTRACTOR

KOHLMEIER, ROBERT J.
17174 JEAN STREET
FT. MYERS, FL 33912
LICENSE NO:2352

WATER WELL CONSTRUCTION PERMIT # SF050400A
EXPIRATION DATE: November 09, 2000

PROJECT: FT. MYERS PRODUCTION WELL P-3 (AKA WELL #40)
TYPE OF USE: PUBLIC WATER SUPPLY
COUNTY: LEE SEC: 28 TWP: 44 RGE: 25

WELL CONSTRUCTION SPECIFICATIONS:

INNER

OUTER

CASING DIAMETER:	16"	24"
CASING DEPTH:	475.00'	100.00'
SCREENED INTERVAL:	-	
OPEN HOLE INTERVAL:	475' - 800'	
TOTAL DEPTH OF WELL:	800.00'	
GROUT REQUIREMENT:		

Inner casing shall be grouted bottom to top.
Outer casing shall be grouted bottom to top.

See additional conditions of permit on attached sheet.

We appreciate your assistance and cooperation in better managing the water resources of the District. If you have any questions on this matter, please call Ann-Marie Superchi at extension 6929.

Sincerely,

Jeffrey Rosenfeld, P.G., Supervising Professional
Water Use Division, Regulation Department

Attachment: Additional Conditions of Permit

c: MR. JACK MCCOY-LEE CO. DNR
MR. GARY MAIER-LEE COUNTRY HEALTH DEPT. ENVIRONMENTAL ENG.
MR. BILL BEDDOW-CH2M HILL

GOVERNING BOARD

Michael Collins, Chairman
Michael D. Minton, Vice Chairman

Vera M. Carter
Gerardo B. Fernan-Luz

Nicolas J. Gutierrez, Jr.
Markus P. Thornton

EXECUTIVE OFFICE

Frank R. Finch, P.E., Executive Director
James E. Blount, Chief of Staff

ENVIRONMENTAL ENGINEERING
Lee County Health Department
60 Danley Drive, Unit 1
Fort Myers, Florida 33907

STANDARD CONDITIONS FOR PUBLIC WATER SYSTEMS

1. Well will be constructed in accordance with all applicable provisions of Chapter 62-555, Florida Administrative Code.
2. The top of the well casing shall be extended to a point above the final grade level so as not to be subject to flooding and will be protected by a concrete apron. The apron must be a minimum of four inches (4") thick, the size of six feet (6') by six feet (6') around the well with a pitch of three inches (3") and ten feet (10') away from the well. A waterproof seal shall be installed at the upper terminus of the well casing to prevent contaminant from entering the well through openings for piping, electrical connections or vents.
3. An accessible down opening non-threaded sampling spigot will be provided on the discharge side of the well pump at a minimum distance of eighteen (18") above the ground surface.
4. Wells will be located a minimum of 100 feet from any potential source of contamination. When the potential contamination source is a septic tank, the following minimum standards will apply:
 - a. 200' when the well is for a Community, Non Transient - Non Community or Non Community Water System as defined in Section 403.852(2) and (3), Florida Statutes;
 - b. 100' when the well is for a Non Community Water System having a projected sewage flow of not more than 2000 gallons per day, or for a Limited Use Public Water System not included in the "Florida Safe Drinking Water Act."
5. Drainage from parking lot areas will be diverted away from the well site.
6. A protective structure will be provided around the well to protect it from physical damage and to prevent unauthorized tampering.
7. Copies of the well completion report and other pertinent information must be submitted to the above address within fifteen (15) days of well completion.



SOUTH FLORIDA WATER MANAGEMENT DISTRICT

3301 Gun Club Road, West Palm Beach, Florida 33406 • (561) 686-8800 • FL WATS 1-800-432-2045 • TDD (561) 697-2574
Mailing Address: P.O. Box 24680, West Palm Beach, FL 33416-4680 • www.sfwmd.gov

CON 24-06

May 09, 2000

PERMITTEE
CITY OF FORT MYERS
P.O. BOX 2217
FT. MYERS, FL 33902

CONTRACTOR
KOHLMETTER, ROBERT J.
17174 JEAN STREET
FT. MYERS, FL 33912
LICENSE NO:2352

WATER WELL CONSTRUCTION PERMIT # SF050400B
EXPIRATION DATE: November 09, 2000

PROJECT: FT. MYERS PRODUCTION WELL P-4 (AKA WELL #41)
TYPE OF USE: PUBLIC WATER SUPPLY
COUNTY: LEE SEC: 28 TWP: 44 RGE: 25

WELL CONSTRUCTION SPECIFICATIONS:	<u>INNER</u>	<u>OUTER</u>
CASING DIAMETER:	16"	24"
CASING DEPTH:	475.00'	100.00'
SCREENED INTERVAL:	-	
OPEN HOLE INTERVAL:	475' - 800'	
TOTAL DEPTH OF WELL:	800.00'	
GROUT REQUIREMENT:		

Inner casing shall be grouted bottom to top.
Outer casing shall be grouted bottom to top.

See additional conditions of permit on attached sheet.

We appreciate your assistance and cooperation in better managing the water resources of the District. If you have any questions on this matter, please call Ann-Marie Superchi at extension 6929.

Sincerely,

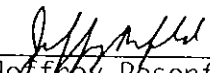
Jeffrey Rosenfeld, P.G., Supervising Professional
Water Use Division, Regulation Department

Attachment: Additional Conditions of Permit
c: MR. JACK MCCOY-LEE CO. DNR
MR. GARY MAIER-LEE COUNTRY HEALTH DEPT. ENVIRONMENTAL ENG.
MR. BILL BEDDOW-CH2M HILL

GOVERNING BOARD

Michael Collins, Chairman
Michael D. Minton, Vice Chairman

Vera M. Carter
Gerardo B. Fernandez

Nicolas J. Gutierrez, Jr.
Harkley R. Thornton

EXECUTIVE OFFICE

Frank R. Finch, P.E., Executive Director
James E. Blount, Chief of Staff

ENVIRONMENTAL ENGINEERING
Lee County Health Department
60 Danley Drive, Unit 1
Fort Myers, Florida 33907

STANDARD CONDITIONS FOR PUBLIC WATER SYSTEMS

1. Well will be constructed in accordance with all applicable provisions of Chapter 62-555, Florida Administrative Code.
2. The top of the well casing shall be extended to a point above the final grade level so as not to be subject to flooding and will be protected by a concrete apron. The apron must be a minimum of four inches (4") thick, the size of six feet (6') by six feet (6') around the well with a pitch of three inches (3") and ten feet (10') away from the well. A waterproof seal shall be installed at the upper terminus of the well casing to prevent contaminant from entering the well through openings for piping, electrical connections or vents.
3. An accessible down opening non-threaded sampling spigot will be provided on the discharge side of the well pump at a minimum distance of eighteen (18") above the ground surface.
4. Wells will be located a minimum of 100 feet from any potential source of contamination. When the potential contamination source is a septic tank, the following minimum standards will apply:
 - a. 200' when the well is for a Community, Non Transient - Non Community or Non Community Water System as defined in Section 403.852(2) and (3), Florida Statutes;
 - b. 100' when the well is for a Non Community Water System having a projected sewage flow of not more than 2000 gallons per day, or for a Limited Use Public Water System not included in the "Florida Safe Drinking Water Act."
5. Drainage from parking lot areas will be diverted away from the well site.
6. A protective structure will be provided around the well to protect it from physical damage and to prevent unauthorized tampering.
7. Copies of the well completion report and other pertinent information must be submitted to the above address within fifteen (15) days of well completion.



SOUTH FLORIDA WATER MANAGEMENT DISTRICT

3301 Gun Club Road, West Palm Beach, Florida 33406 • (561) 686-8800 • FL WATS 1-800-432-2045 • TDD (561) 697-2574
Mailing Address: P.O. Box 24680, West Palm Beach, FL 33416-4680 • www.sfwmd.gov

CON 24-06

May 09, 2000

PERMITTEE

CITY OF FORT MYERS
P.O. BOX 2217
FT. MYERS, FL 33902

CONTRACTOR

KOHLMEIER, ROBERT J.
17174 JEAN STREET
FT. MYERS, FL 33912
LICENSE NO:2352

WATER WELL CONSTRUCTION PERMIT # SF050400C
EXPIRATION DATE: November 09, 2000

PROJECT: FT. MYERS PRODUCTION WELL P-5 (AKA WELL #42)
TYPE OF USE: PUBLIC WATER SUPPLY
COUNTY: LEE SEC: 28 TWP: 44 RGE: 25

WELL CONSTRUCTION SPECIFICATIONS:

INNER

OUTER

CASING DIAMETER:	16"	24"
CASING DEPTH:	475.00'	100.00'
SCREENED INTERVAL:	-	
OPEN HOLE INTERVAL:	475' - 800'	
TOTAL DEPTH OF WELL:	800.00'	
GROUT REQUIREMENT:		

Inner casing shall be grouted bottom to top.
Outer casing shall be grouted bottom to top.

See additional conditions of permit on attached sheet.

We appreciate your assistance and cooperation in better managing the water resources of the District. If you have any questions on this matter, please call Ann-Marie Superchi at extension 6929.

Sincerely,

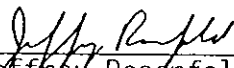
Jeffrey Rosenfeld, P.G., Supervising Professional
Water Use Division, Regulation Department

Attachment: Additional Conditions of Permit

- c: MR. JACK MCCOY-LEE CO. DNR
- MR. GARY MAIER-LEE COUNTRY HEALTH DEPT. ENVIRONMENTAL ENG.
- MR. BILL BEDDOW-CH2M HILL

GOVERNING BOARD

Michael Collins, Chairman
Michael D. Minton, Vice-Chairman
Vera M. Carter
Camardo B. Ferrer
Nicolas J. Gutierrez, Jr.
Markham B. Thayer

EXECUTIVE OFFICE

Frank R. Finch, P.E., Executive Director
L. E. Blum, P.E., Chief Engineer

ENVIRONMENTAL ENGINEERING
Lee County Health Department
60 Danley Drive, Unit 1
Fort Myers, Florida 33907

STANDARD CONDITIONS FOR PUBLIC WATER SYSTEMS

1. Well will be constructed in accordance with all applicable provisions of Chapter 62-555, Florida Administrative Code.
2. The top of the well casing shall be extended to a point above the final grade level so as not to be subject to flooding and will be protected by a concrete apron. The apron must be a minimum of four inches (4") thick, the size of six feet (6') by six feet (6') around the well with a pitch of three inches (3") and ten feet (10') away from the well. A waterproof seal shall be installed at the upper terminus of the well casing to prevent contaminant from entering the well through openings for piping, electrical connections or vents.
3. An accessible down opening non-threaded sampling spigot will be provided on the discharge side of the well pump at a minimum distance of eighteen (18") above the ground surface.
4. Wells will be located a minimum of 100 feet from any potential source of contamination. When the potential contamination source is a septic tank, the following minimum standards will apply:
 - a. 200' when the well is for a Community, Non Transient - Non Community or Non Community Water System as defined in Section 403.852(2) and (3), Florida Statutes;
 - b. 100' when the well is for a Non Community Water System having a projected sewage flow of not more than 2000 gallons per day, or for a Limited Use Public Water System not included in the "Florida Safe Drinking Water Act."
5. Drainage from parking lot areas will be diverted away from the well site.
6. A protective structure will be provided around the well to protect it from physical damage and to prevent unauthorized tampering.
7. Copies of the well completion report and other pertinent information must be submitted to the above address within fifteen (15) days of well completion.



157775

SOUTH FLORIDA WATER MANAGEMENT DISTRICT

3301 Gun Club Road, West Palm Beach, Florida 33406 • (561) 686-8800 • FL WATS 1-800-432-2045 • TDD (561) 697-2574
Mailing Address: P.O. Box 24680, West Palm Beach, FL 33416-4680 • www.sfwmd.gov

CON 24-06

July 03, 2000

PERMITTEE

CITY OF FORT MYERS
P.O. BOX 2217
FT. MYERS, FL 33902

CONTRACTOR

KOHLMEIER, ROBERT J.
17174 JEAN STREET
FT. MYERS, FL 33912
LICENSE NO:2352

WATER WELL CONSTRUCTION PERMIT # SF050400D
EXPIRATION DATE: January 03, 2001

PROJECT: FT. MYERS PRODUCTION WELL P-6 (AKA WELL #43)
TYPE OF USE: PUBLIC WATER SUPPLY
COUNTY: LEE SEC: 28 TWP: 44 RGE: 25

WELL CONSTRUCTION SPECIFICATIONS:

	INNER	OUTER
CASING DIAMETER:	16"	24"
CASING DEPTH:	475.00'	100.00'
SCREENED INTERVAL:	-	-
OPEN HOLE INTERVAL:	475' - 800'	-
TOTAL DEPTH OF WELL:	800.00'	-
GROUT REQUIREMENT:		

Inner casing shall be grouted bottom to top.
Outer casing shall be grouted bottom to top.

See additional conditions of permit on attached sheet.

We appreciate your assistance and cooperation in better managing the water resources of the District. If you have any questions on this matter, please call Ann-Marie Superchi at extension 6929.

Sincerely,

Kurt Leckler, Supervising Hydrogeologist
Water Use Regulation Department, Water Supply Division

Attachment: Additional Conditions of Permit

- c: MR. JACK MCCOY-LEE CO. DNR
- MR. GARY MAIER-LEE COUNTRY HEALTH DEPT. ENVIRONMENTAL ENG.
- MR. BILL BEDDOW-CH2M HILL

GOVERNING BOARD

Michael Collins, *Chairman*
Michael D. Minton, *Vice Chairman*
Mitchell W. Berger

Vera M. Carter
Gerardo B. Fernandez
Patrick J. Gleason

Nicolas J. Gutierrez, Jr.
Harkley R. Thornton
Trudi K. Williams

EXECUTIVE OFFICE

Frank R. Finch, P.E., *Executive Director*
James E. Blount, *Chief of Staff*

ENVIRONMENTAL ENGINEERING
Lee County Health Department
60 Danley Drive, Unit 1
Fort Myers, Florida 33907

STANDARD CONDITIONS FOR PUBLIC WATER SYSTEMS

1. Well will be constructed in accordance with all applicable provisions of Chapter 62-555, Florida Administrative Code.
2. The top of the well casing shall be extended to a point above the final grade level so as not to be subject to flooding and will be protected by a concrete apron. The apron must be a minimum of four inches (4") thick, the size of six feet (6') by six feet (6') around the well with a pitch of three inches (3") and ten feet (10') away from the well. A waterproof seal shall be installed at the upper terminus of the well casing to prevent contaminant from entering the well through openings for piping, electrical connections or vents.
3. An accessible down opening non-threaded sampling spigot will be provided on the discharge side of the well pump at a minimum distance of eighteen (18") above the ground surface.
4. Wells will be located a minimum of 100 feet from any potential source of contamination. When the potential contamination source is a septic tank, the following minimum standards will apply:
 - a. 200' when the well is for a Community, Non Transient - Non Community or Non Community Water System as defined in Section 403.852(2) and (3), Florida Statutes;
 - b. 100' when the well is for a Non Community Water System having a projected sewage flow of not more than 2000 gallons per day, or for a Limited Use Public Water System not included in the "Florida Safe Drinking Water Act."
5. Drainage from parking lot areas will be diverted away from the well site.
6. A protective structure will be provided around the well to protect it from physical damage and to prevent unauthorized tampering.
7. Copies of the well completion report and other pertinent information must be submitted to the above address within fifteen (15) days of well completion.



SOUTH FLORIDA WATER MANAGEMENT DISTRICT

3301 Gun Club Road, West Palm Beach, Florida 33406 • (561) 686-8800 • FL WATS 1-800-432-2045 • TDD (561) 697-2574
Mailing Address: P.O. Box 24680, West Palm Beach, FL 33416-4680 • www.sfwmd.gov

157775

CON 24-06

July 03, 2000

PERMITTEE
CITY OF FORT MYERS
P.O. BOX 2217
FT. MYERS, FL 33902

CONTRACTOR
KOHLMEIER, ROBERT J.
17174 JEAN STREET
FT. MYERS, FL 33912
LICENSE NO:2352

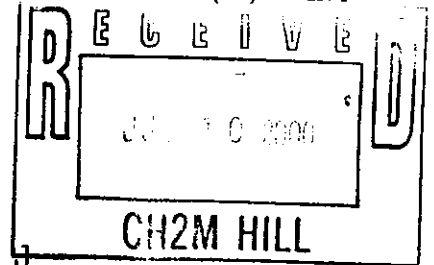

WATER WELL CONSTRUCTION PERMIT # SF050400E
EXPIRATION DATE: January 03, 2001

PROJECT: FT. MYERS PRODUCTION WELL P-7 (AKA WELL #44)
TYPE OF USE: PUBLIC WATER SUPPLY
COUNTY: LEE SEC: 28 TWP: 44 RGE: 25

WELL CONSTRUCTION SPECIFICATIONS:	INNER	OUTER
CASING DIAMETER:	16"	24"
CASING DEPTH:	475.00'	100.00'
SCREENED INTERVAL:	-	
OPEN HOLE INTERVAL:	475' - 800'	
TOTAL DEPTH OF WELL:	800.00'	
GROUT REQUIREMENT:		

Inner casing shall be grouted bottom to top.
Outer casing shall be grouted bottom to top.

See additional conditions of permit on attached sheet.

We appreciate your assistance and cooperation in better managing the water resources of the District. If you have any questions on this matter, please call Ann-Marie Superchi at extension 6929.

Sincerely,

Kurt Leckler, Supervising Hydrogeologist
Water Use Regulation Department, Water Supply Division

Attachment: Additional Conditions of Permit
c: MR. JACK MCCOY-LEE CO. DNR
MR. GARY MAIER-LEE COUNTRY HEALTH DEPT. ENVIRONMENTAL ENG.
MR. BILL BEDDOW-CH2M HILL

GOVERNING BOARD

Michael Collins, Chairman
Michael D. Minton, Vice Chairman
Vera M. Carter
Gerardo B. Fernandez
Nicolas J. Gutierrez, Jr.
Harkley R. Thornton

EXECUTIVE OFFICE

Frank R. Finch, P.E., Executive Director
James E. Blount, Chief of Staff

ENVIRONMENTAL ENGINEERING
Lee County Health Department
60 Danley Drive, Unit 1
Fort Myers, Florida 33907

STANDARD CONDITIONS FOR PUBLIC WATER SYSTEMS

1. Well will be constructed in accordance with all applicable provisions of Chapter 62-555, Florida Administrative Code.
2. The top of the well casing shall be extended to a point above the final grade level so as not to be subject to flooding and will be protected by a concrete apron. The apron must be a minimum of four inches (4") thick, the size of six feet (6') by six feet (6') around the well with a pitch of three inches (3") and ten feet (10') away from the well. A waterproof seal shall be installed at the upper terminus of the well casing to prevent contaminant from entering the well through openings for piping, electrical connections or vents.
3. An accessible down opening non-threaded sampling spigot will be provided on the discharge side of the well pump at a minimum distance of eighteen (18") above the ground surface.
4. Wells will be located a minimum of 100 feet from any potential source of contamination. When the potential contamination source is a septic tank, the following minimum standards will apply:
 - a. 200' when the well is for a Community, Non Transient - Non Community or Non Community Water System as defined in Section 403.852(2) and (3), Florida Statutes;
 - b. 100' when the well is for a Non Community Water System having a projected sewage flow of not more than 2000 gallons per day, or for a Limited Use Public Water System not included in the "Florida Safe Drinking Water Act."
5. Drainage from parking lot areas will be diverted away from the well site.
6. A protective structure will be provided around the well to protect it from physical damage and to prevent unauthorized tampering.
7. Copies of the well completion report and other pertinent information must be submitted to the above address within fifteen (15) days of well completion.

APPENDIX B

Lithologic Description of Formation Samples

**Table B-1
Fort Myers Brackish Water Wellfield Lithologies**

Depth (feet bls)		Lithologic Descriptions				
From	To	Well P-3	Well P-4	Well P-5	Well P-6	Well P-7
0	10	Shells and shell fragments, unconsolidated	Shells and shell fragments, unconsolidated	Shells and shell fragments, unconsolidated	Shells and shell fragments, unconsolidated	Shells and shell fragments, unconsolidated
10	20	Same as above	Same as above	Same as above	Same as above	Same as above
20	30	Shells and shell fragments (85%); phosphate (10%); sandy limestone, yellowish gray (5Y 7/2), medium grained, medium porosity, moderately consolidated (5%)	Shells and shell fragments (85%); sandy limestone, yellowish gray (5Y 7/2), medium grained, medium porosity, moderately consolidated (10%); phosphate (5%)	Shells and shell fragments (75%); sandy limestone, yellowish gray (5Y 7/2), medium grained, medium porosity, moderately consolidated (5%); phosphate (20%)	Same as above	Same as above
30	40	Clay, light olive gray (5Y 5/2), low plasticity, low porosity	Clay, light olive gray (5Y 5/2), low plasticity, low porosity	Sandy clay, light olive gray (5Y 5/2), medium plasticity, low porosity	Sandy clay, light olive gray (5Y 5/2), medium plasticity, low porosity	Sandy clay, light olive gray (5Y 5/2), medium plasticity, low porosity
40	50	Same as above	Same as above	Clay, same as above	Same as above	Same as above
50	60	Same as above	Same as above	Same as above	Same as above	Same as above
60	70	Clay, olive gray (5Y 4/1), medium plasticity, low porosity, phosphatic	Clay, olive gray (5Y 4/1), medium plasticity, low porosity, phosphatic	Sandy clay, olive gray (5Y 4/1), high plasticity, low porosity	Same as above	Same as above
70	80	Sandy clay, grayish olive (10Y 4/1), medium plasticity, low porosity	Sandy clay, light olive gray (5Y 5/2), low plasticity, low porosity	Same as above, shell fragments (10%)	Same as above	Sandy limestone, medium light gray (N6), moderate consolidation, moderate porosity
80	90	Clay (90%), dark greenish gray (5GY 4/1), low plasticity, low porosity, phosphatic; shell fragments (10%), unconsolidated	Sandy limestone, light olive gray (5Y 5/2), medium grained, moderate porosity, moderate consolidation; shell fragments	Clay, (5Y 4/1), low plasticity, low porosity	Sandy limestone, light olive gray (5Y 5/2), medium grained, moderate porosity, moderate consolidation; shell fragments	Same as above
90	100	Sandy limestone, light olive gray (5Y 5/2), medium grained, moderate porosity, moderate consolidation; shell fragments	Same as above	Sandy limestone, light olive gray (5Y 5/2), medium grained, moderate porosity, moderate consolidation; shell fragments	Same as above, no shell fragments	Same as above

**Table B-1 (continued)
Fort Myers Brackish Water Wellfield Lithologies**

Depth (feet bls)		Lithologic Descriptions				
From	To	Well P-3	Well P-4	Well P-5	Well P-6	Well P-7
100	110	Clay (90%), light olive gray (5Y 5/2), low porosity, moderate plasticity, trace of fine grained quartz sand; unconsolidated shell fragments (10%)	Clay (90%), light olive gray (5Y 5/2), low porosity, moderate plasticity, trace of fine grained quartz sand; unconsolidated shell fragments (10%)	Sandy limestone, light olive gray (5Y 4/1), medium grained, moderate porosity, moderate consolidation; shell fragments	Same as above	Same as above
110	120	Same as above, decrease clay to 80%, increase shell fragments to 20%	Same as above	Same as above	Same as above	Sandy limestone, light olive gray (5Y 4/1), medium grained, moderate porosity, moderate consolidation; shell fragments
120	130	Same as above, decrease clay to 60%, increase shell fragments to 40%	Same as above, decrease clay to 70%, increase shell fragments to 20%, add 10% sandy limestone, dark yellowish orange (10YR 6/6), medium grained, well consolidated, low porosity	Same as above, add shells (10%)	Clay, light olive gray (5GY 5/2), low plasticity, low porosity	Clay, light olive gray (5GY 5/2), low plasticity, low porosity
130	140	Clay (60%) pale olive (10Y 6/2), low porosity, moderate plasticity; limestone (40%), yellowish gray (5Y 8/1), low porosity, poorly consolidated	Clay, dark greenish gray (5G 4/1), low porosity, moderate plasticity	Same as above	Same as above	Same as above
140	150	Clay (80%), light olive gray (5Y 5/2), low porosity, moderate plasticity, trace of fine grained quartz sand; unconsolidated shell fragments (10%), sandy limestone (10%), dark yellowish orange (10YR 6/6), medium grained, well consolidated, low porosity	Same as above	Clay, dark greenish gray (5GY 4/1), low porosity, moderate plasticity	Same as above	Same as above

Table B-1 (continued)
Fort Myers Brackish Water Wellfield Lithologies

Depth (feet bls)		Lithologic Descriptions				
From	To	Well P-3	Well P-4	Well P-5	Well P-6	Well P-7
150	160	Clay, dark greenish gray (5G 4/1), low porosity, high plasticity	Same as above, high plasticity	Same as above	Same as above	Limestone (60%), yellowish gray (5Y 7/2), low porosity, moderately consolidated; clay (40%), dark greenish gray (5G 4/1), low porosity, moderate plasticity; phosphate (10%)
160	170	Same as above	Same as above	Clay, dark greenish gray (5G 4/1), low porosity, low plasticity	Limestone (70%), yellowish gray (5Y 7/2), low porosity, moderately consolidated; clay (20%), dark greenish gray (5G 4/1), low porosity, moderate plasticity; phosphate (10%)	Clay, dark greenish gray (5G 4/1), low porosity, low plasticity
170	180	Same as above, phosphatic	Same as above	Same as above	Clay (70%) Same as above, phosphatic, sandy limestone (20%), greenish gray (5GY 6/1), moderate consolidation, low porosity, shell fragments (10%)	Limestone (60%), yellowish gray (5Y 7/2), low porosity, moderately consolidated; clay (40%), dusky yellow (5Y 6/4), low porosity, moderate plasticity; phosphate (10%)
180	190	Same as above, decrease clay to 70%, add limestone (30%), yellowish gray (5Y 7/2), low porosity, moderately consolidated	Same as above, decrease clay to 40%, add limestone (60%), yellowish gray (5Y 7/2), low porosity, moderately consolidated	Clay (50%) Same as above, phosphatic, sandy limestone (40%), greenish gray (5GY 6/1), moderate consolidation, low porosity, shell fragments (10%)	Same as above	Limestone (60%), yellowish gray (5Y 7/2), low porosity, moderately consolidated; clay (40%), yellowish gray (5Y 7/2), low porosity, moderate plasticity

Table B-1 (continued)
Fort Myers Brackish Water Wellfield Lithologies

Depth (feet bls)		Lithologic Descriptions				
From	To	Well P-3	Well P-4	Well P-5	Well P-6	Well P-7
190	200	Clay (50%), dusky yellow (5Y 6/4), low porosity, moderate plasticity; limestone (40%), yellowish gray (5Y 7/2), low porosity, moderately consolidated; phosphate (10%)	Clay (50%), dusky yellow (5Y 6/4), low porosity, moderate plasticity; limestone (40%), yellowish gray (5Y 7/2), low porosity, moderately consolidated; phosphate (10%)	Same as above	Same as above	Same as above, increase limestone to 70%, decrease clay to 30%, phosphatic clay
200	210	Same as above, decrease clay to 10%, increase limestone to 80%	Same as above, increase clay to 40%, decrease limestone to 60%	Clay (50%), pale olive (10Y 6/2), low porosity, low plasticity, shell fragments (50%)	Limestone (60%), yellowish gray (5Y 7/2), low porosity, moderately consolidated; clay (40%), yellowish gray (5Y 7/2), low porosity, moderate plasticity, phosphatic	Same as above, increase limestone to 80%, decrease clay to 20%
210	220	Same as above	Same as above, decrease clay to 10%, increase limestone to 80%	Same as above	Same as above	Same as above
220	230	Limestone (80%), yellowish gray (5Y 7/2), low porosity, moderately consolidated; clay (20%), yellowish gray (5Y 7/2), low porosity, moderate plasticity	Limestone (70%), yellowish gray (5Y 7/2), low porosity, moderately consolidated; clay (30%), yellowish gray (5Y 7/2), low porosity, moderate plasticity	Same as above	Same as above	Same as above, shell fragments
230	240	Same as above, decrease limestone to 70%, increase clay to 30%	Same as above	Clay (80%), dark greenish gray (5GY 4/1), low porosity, moderate plasticity, shell fragments (20%)	Same as above	Same as above
240	250	Same as above	Same as above, increase limestone to 80%, decrease clay to 20%	Same as above	Same as above	Same as above, decrease limestone to 30%, increase clay to 70%

**Table B-1 (continued)
Fort Myers Brackish Water Wellfield Lithologies**

Depth (feet bls)		Lithologic Descriptions				
From	To	Well P-3	Well P-4	Well P-5	Well P-6	Well P-7
250	260	Same as above	Same as above, increase clay to 60%, decrease limestone to 40%	Sandy limestone, yellowish gray (5Y 7/2), phosphatic, poorly consolidated, high porosity	Same as above	Clay, yellowish gray (5Y 7/2), low porosity, moderate plasticity, phosphatic
260	270	Same as above	Same as above, decrease clay to 50%, increase limestone to 50%	Same as above	Same as above	Clay, pale olive (10Y 6/2), low plasticity, low porosity
270	280	Same as above	Same as above, decrease clay to 20%, increase limestone to 80%	Same as above	Clay, pale olive (10Y 6/2), low plasticity, low porosity	Same as above, very phosphatic
280	290	Same as above, decrease limestone to 60%, increase clay to 40%	Same as above	Same as above	Same as above	Clay (90%), yellowish gray (5Y 7/2), low porosity, low plasticity, phosphatic; limestone (10%), light gray (N8), low porosity, well consolidated, fine grained
290	300	Same as above, increase limestone to 80%, decrease clay to 20%	Same as above, increase limestone to 90%, decrease clay to 10%	Same as above	Same as above	Same as above
300	310	Same as above	Clay (90%), yellowish gray (5Y 7/2), low porosity, high plasticity; micrite (10%), light gray, low porosity, well consolidated	Clay (90%), yellowish gray (5Y 7/2), low porosity, high plasticity; micrite (10%), light gray, low porosity, well consolidated	Same as above, decrease clay to 70%, add limestone (30%), light gray (N8), low porosity, well consolidated, fine grained	Same as above

Table B-1 (continued)
Fort Myers Brackish Water Wellfield Lithologies

Depth (feet bls)		Lithologic Descriptions				
From	To	Well P-3	Well P-4	Well P-5	Well P-6	Well P-7
310	320	Same as above, decrease limestone to 60%, increase clay to 40%	Same as above	Same as above	Same as above, increase clay to 90%, decrease limestone to 10%	Sandy limestone (80%), yellowish gray (5Y 8/1), poorly consolidated, moderate porosity, fine grained, phosphatic, shell molds; clay (20%), yellowish gray (5Y 7/2), low porosity, low plasticity, phosphatic
320	330	Clay (90%), yellowish gray (5Y 7/2), low porosity, high plasticity; micrite (10%), light gray, low porosity, well consolidated	Same as above	Clay, dusky yellow green (5GY 5/2), low porosity, moderate plasticity	Sandy limestone (80%), yellowish gray (5Y 8/1), poorly consolidated, moderate porosity, fine grained, phosphatic, shell molds; clay (20%), yellowish gray (5Y 7/2), low porosity, low plasticity, phosphatic	Same as above, decrease limestone to 70%, increase clay to 30%
330	340	Clay, dark greenish clay (5G 4/1), low porosity, high plasticity	Clay, dark greenish clay (5G 4/1), low porosity, high plasticity	Clay (60%), light olive gray (5Y 6/1), low porosity, low plasticity, phosphatic; limestone (40%), yellowish gray, phosphatic, moderate porosity, poorly consolidated	Same as above	Same as above
340	350	Same as above	Same as above	Same as above	Clay (90%), yellowish gray (5Y 7/2), low porosity, low plasticity, phosphatic; limestone (10%), light gray (N8), low porosity, well consolidated, fine grained	Clay (90%), yellowish gray (5Y 7/2), low porosity, low plasticity, phosphatic; limestone (10%), light gray (N8), low porosity, well consolidated, fine grained

Table B-1 (continued)
Fort Myers Brackish Water Wellfield Lithologies

Depth (feet bls)		Lithologic Descriptions				
From	To	Well P-3	Well P-4	Well P-5	Well P-6	Well P-7
350	360	Clay, light olive gray (5Y 6/1), low porosity, low plasticity, phosphatic	Clay (80%), light olive gray (5Y 6/1), low porosity, low plasticity, phosphatic; limestone (20%), yellowish gray, phosphatic, moderate porosity, poorly consolidated	Same as above	Same as above	Same as above
360	370	Same as above	Same as above	Clay (70%), yellowish gray (5Y 8/1), low porosity, moderate plasticity; limestone (30%), yellowish gray, phosphatic, moderate porosity, poorly consolidated	Same as above, decrease clay to 50%, increase limestone to 50%	Same as above
370	380	Clay (70%), yellowish gray (5Y 8/1), low porosity, moderate plasticity; limestone (30%), yellowish gray, phosphatic, moderate porosity, poorly consolidated	Clay, pale olive (10Y 6/2), low porosity, moderate plasticity	Limestone (70%), yellowish gray, phosphatic, moderate porosity, poorly consolidated, clay (30%), yellowish gray (5Y 8/1), low porosity, moderate plasticity;	Same as above	Clay (70%), light olive gray (5Y 5/2), low porosity, low plasticity, limestone (20%), yellowish gray, phosphatic, moderate porosity, poorly consolidated, fine grained, phosphate (10%)
380	390	Clay, pale olive (10Y 6/2), low porosity, moderate plasticity	Same as above	Same as above	Clay (70%), light olive gray (5Y 5/2), low porosity, low plasticity, limestone (20%), yellowish gray, phosphatic, moderate porosity, poorly consolidated, fine grained, phosphate (10%)	Clay (80%), yellowish gray (5Y 7/2), low porosity, low plasticity, phosphatic; limestone (20%), light gray (N8), low porosity, well consolidated, fine grained

Table B-1 (continued)
Fort Myers Brackish Water Wellfield Lithologies

Depth (feet bls)		Lithologic Descriptions				
From	To	Well P-3	Well P-4	Well P-5	Well P-6	Well P-7
390	400	Clay (70%), yellowish gray (5Y 8/1), low porosity, moderate plasticity; limestone (30%), yellowish gray, phosphatic, moderate porosity, poorly consolidated	Clay (70%), yellowish gray (5Y 8/1), low porosity, moderate plasticity; limestone (30%), yellowish gray, phosphatic, moderate porosity, poorly consolidated	Same as above	Same as above	Clay (90%), light olive gray (5Y 5/2), low porosity, moderate plasticity, limestone (10%), yellowish gray, phosphatic, moderate porosity, poorly consolidated, fine grained
400	410	Same as above	Same as above, increase clay to 80%, decrease limestone to 20%	Same as above	Same as above	Same as above, clay has low plasticity
410	420	Clay (90%), yellowish gray (5Y 8/1), low porosity, moderate plasticity; micrite (10%), light gray (N7), low porosity, poorly consolidated	Clay, yellowish gray (5Y 8/1), low porosity, moderate plasticity	Clay, yellowish gray (5Y 7/2), low porosity, moderate plasticity	Clay (90%), light olive gray (5Y 5/2), low porosity, moderate plasticity, limestone (10%), yellowish gray, phosphatic, moderate porosity, poorly consolidated, fine grained	Same as above
420	430	Same as above	Clay, yellowish gray (5Y 7/2), low porosity, moderate plasticity	Same as above	Clay (70%), yellowish gray (5Y 7/2), low porosity, low plasticity, phosphatic; limestone (30%), yellowish gray (5Y 8/1), poorly consolidated, moderate porosity, fine grained, phosphatic, shell molds	Clay (70%), yellowish gray (5Y 7/2), low porosity, low plasticity, phosphatic; limestone (30%), yellowish gray (5Y 8/1), poorly consolidated, moderate porosity, fine grained, phosphatic, shell molds
430	440	Same as above	Same as above	Same as above	Limestone, yellowish gray (5GY 8/1) to very light gray (N8), poorly consolidated, moderately consolidated, fine grained; shell molds	Same as above, increase limestone to 70%, decrease clay to 30%

**Table B-1 (continued)
Fort Myers Brackish Water Wellfield Lithologies**

Depth (feet bls)		Lithologic Descriptions				
From	To	Well P-3	Well P-4	Well P-5	Well P-6	Well P-7
440	450	Same as above	Same as above	Clay, dark greenish gray (5G 4/1), low porosity, high plasticity	Same as above	Same as above
450	460	Same as above	Same as above	Same as above	Same as above	Limestone, yellowish gray (5GY 8/1) to very light gray (N8), poorly consolidated, moderately consolidated, fine grained; shell molds
460	470	Same as above	Same as above	Same as above	Limestone, very light gray (N8) to white (N9), moderate porosity, well consolidated, fine grained, abundant shell molds	Same as above
470	480	Clay (60%), grayish olive (10Y 4/2), low porosity, moderate plasticity; limestone (40%), yellowish gray (5Y 7/2), fine grained, well consolidated, moderate porosity	Limestone (70%), yellowish gray (5Y 7/2), fine grained, well consolidated, moderate porosity; clay (30%), grayish olive (10Y 4/2), low porosity, moderate plasticity	Limestone (60%), yellowish gray (5Y 7/2), fine grained, well consolidated, moderate porosity; clay (40%), dark greenish gray (5G 4/1), low porosity, high plasticity	Same as above	Same as above
480	490	Limestone, yellowish gray (5Y 7/2), fine grained, moderately consolidated, moderate porosity	Same as above, decrease limestone to 60%, increase clay to 40%	Limestone, yellowish gray (5Y 7/2), fine grained, well consolidated, moderate porosity	Same as above	Limestone, very light gray (N8) to white (N9), moderate porosity, well consolidated, fine grained, abundant shell molds
490	500	Limestone, yellowish gray (5Y 7/2), fine grained, well consolidated, moderate porosity	Limestone, yellowish gray (5Y 7/2), fine grained, well consolidated, moderate porosity	Same as above	Same as above	Same as above

Table B-1 (continued)
Fort Myers Brackish Water Wellfield Lithologies

Depth (feet bis)		Lithologic Descriptions				
From	To	Well P-3	Well P-4	Well P-5	Well P-6	Well P-7
500	510	Clay (60%), greenish gray (5GY 6/1), low porosity, moderate plasticity; limestone (40%), yellowish gray (5Y 7/2), well consolidated, moderate porosity, fine grained, abundant fossil molds	Clay (70%), greenish gray (5GY 6/1), low porosity, moderate plasticity; limestone (30%), yellowish gray (5Y 7/2), well consolidated, moderate porosity, fine grained, abundant fossil molds	Same as above	Same as above	Same as above
510	520	Limestone, yellowish gray (5Y 7/2), well consolidated, moderate porosity, fine grained, abundant fossil molds	Limestone, yellowish gray (5Y 7/2), well consolidated, moderate porosity, fine grained, abundant fossil molds	Same as above	Same as above	Same as above
520	530	Same as above	Same as above	Limestone, very light gray (N8) to white (N9), moderate porosity, well consolidated, fine grained, abundant shell molds	Same as above	Limestone, very pale orange (10YR 8/2), moderate porosity, moderately consolidated, fine grained
530	540	Limestone (80%), yellowish gray (5Y 8/1), poorly consolidated, moderate to high porosity, fine grained, sparry cement; limestone (20%), yellowish gray (5Y 8/1), well consolidated, micritic cement, moderate porosity, fine grained	Clay (80%), greenish gray (5GY 6/1), low porosity, moderate plasticity; limestone (20%), yellowish gray (5Y 7/2), well consolidated, moderate porosity, fine grained, abundant fossil molds	Same as above, moderately consolidated	Same as above	Same as above, abundant fossil molds
540	550	Limestone, yellowish gray (5Y 8/1), poorly consolidated, moderate to high porosity, fine grained	Limestone, yellowish gray (5Y 8/1), poorly consolidated, moderate to high porosity, fine grained	Same as above	Same as above	Same as above

**Table B-1 (continued)
Fort Myers Brackish Water Wellfield Lithologies**

Depth (feet bls)		Lithologic Descriptions				
From	To	Well P-3	Well P-4	Well P-5	Well P-6	Well P-7
550	560	Same as above	Same as above	Same as above, well consolidated	Same as above	Clay, light greenish gray (5G 8/1), low porosity, high plasticity
560	570	Limestone, white (N9), moderately consolidated, moderate porosity, fine grained, abundant shell molds	Limestone, white (N9), moderately to well consolidated, moderate porosity, fine grained, shell molds	Same as above, with shell molds	Clay, light greenish gray (5G 8/1), low porosity, high plasticity	Same as above
570	580	Same as above, moderately to well consolidated	Same as above	Same as above,	Same as above	Limestone, very pale orange (10YR 8/2), moderate porosity, moderately to well consolidated, medium grained
580	590	Same as above, well consolidated, high porosity	Same as above	Same as above	Limestone, very pale orange (10YR 8/2), high porosity, poorly to moderately consolidated, fine to medium grained	Same as above, poorly consolidated
590	600	Limestone, white (N9), poorly consolidated, moderate porosity, fine grained, shell molds	Same as above	Same as above	Same as above, with fossil molds	Same as above, add clay (20%), light greenish gray (5G 8/1), low porosity, medium plasticity
600	610	Limestone, white (N9), low porosity, moderately consolidated, fine grained, shell molds, phosphatic	Same as above, add clay (10%), yellowish gray (5Y 8/1), low porosity, low plasticity, phosphatic	Same as above	Same as above	Same as above
610	620	Same as above, abundant shell molds	Limestone, white (N9), poorly consolidated, moderate porosity, fine grained, phosphatic	Same as above	Same as above	Same as above, decrease clay to 10%

Table B-1 (continued)
Fort Myers Brackish Water Wellfield Lithologies

Depth (feet bls)		Lithologic Descriptions				
From	To	Well P-3	Well P-4	Well P-5	Well P-6	Well P-7
620	630	Same as above, well consolidated	Same as above	Clay, yellowish gray (5Y 8/1), low porosity, high plasticity	Same as above	Same as above
630	640	Same as above	Same as above	Same as above	Same as above	Same as above
640	650	Same as above	Same as above	Limestone, very pale orange (10YR 8/2), high porosity, poorly to moderately consolidated, fine to medium grained	Same as above	Same as above, increase clay to 40%
650	660	Same as above	Clay (80%), light greenish gray (5G 8/1), low porosity, low plasticity, phosphatic; limestone (20%), same as above	Same as above	Same as above, well consolidated, with fossil molds	Same as above
660	670	Same as above	Same as above, clay has low plasticity	Same as above	Same as above	Same as above
670	680	Clay (80%), light greenish gray (5G 8/1), low porosity, low plasticity, phosphatic; limestone (20%), same as above	Same as above, clay has medium plasticity	Same as above, moderately to well consolidated	Same as above	Same as above, with fossil molds
680	690	Same as above	Same as above, clay has high plasticity	Same as above, poorly consolidated	Same as above	Same as above
690	700	Clay (75%), light greenish gray (5G 8/1), low porosity, low plasticity, phosphatic; limestone (25%), very pale orange (10YR 8/2), high porosity, well consolidated, fine to medium grained	Limestone (80%), very pale orange (10YR 8/2), high porosity, poorly to moderately consolidated, fine to medium grained; clay (20%), greenish gray (5G 6/1), low porosity, high plasticity	Same as above	Same as above	Same as above

Table B-1 (continued)
Fort Myers Brackish Water Wellfield Lithologies

Depth (feet bls)		Lithologic Descriptions				
From	To	Well P-3	Well P-4	Well P-5	Well P-6	Well P-7
700	710	Limestone (90%), very pale orange (10YR 8/2), poorly to moderately consolidated, high porosity, fine to medium grained; clay (10%), greenish gray (5G 6/1), low porosity, high plasticity	Same as above	Same as above	Same as above	Same as above
710	720	Same as above, decrease limestone to 50%, increase clay to 50%	Limestone (80%), very pale orange (10YR 8/2), high porosity, poorly consolidated, medium grained; clay (20%), greenish gray (5G 6/1), low porosity, high plasticity	Same as above	Same as above	Same as above
720	730	Limestone, very pale orange (10YR 8/2), high porosity, poorly consolidated, medium grained	Sandstone, COLOR, very fine grained, low porosity, very well consolidated	Same as above, shell molds	Same as above	Same as above
730	740	Clay (60%), greenish gray (5G 6/1), low porosity, high plasticity; limestone (40%), very pale orange (10YR 8/2), high porosity, poorly consolidated, medium grained	Quartz Sand, fine to medium grained, 10% lithics	Same as above	Same as above	Same as above
740	750	Sandy limestone, very pale orange (10YR 8/2), high porosity, poorly consolidated, medium grained, abundant shells	Same as above, add clay (20%), greenish gray (5G 6/1), low porosity, medium plasticity	Limestone, yellowish gray (5Y 8/1), very well consolidate, low porosity, fine grained	Same as above	Same as above
750	760	Same as above	Limestone (80%), very pale orange (10YR 8/2), poorly consolidated, medium grained; clay (20%), greenish gray (5G 6/1), low porosity, high plasticity	Limestone, very pale orange (10YR 8/2), high porosity, poorly to moderately consolidated, fine to medium grained	Same as above	Same as above

Table B-1 (continued)
Fort Myers Brackish Water Wellfield Lithologies

Depth (feet bls)		Lithologic Descriptions				
From	To	Well P-3	Well P-4	Well P-5	Well P-6	Well P-7
760	770	Limestone (50%), very pale orange (10YR 8/2), high porosity, well consolidated, medium grained; limestone (50%), yellowish gray (5Y 8/1), well consolidated, high porosity, medium grained	Same as above, increase limestone to 95%, decrease clay to 5%	Same as above	Clay, yellowish gray (5Y 8/1), high plasticity, low porosity	Clay, yellowish gray (5Y 8/1), high plasticity, low porosity
770	780	Sandy limestone, very pale orange (10YR 8/2), high porosity, poorly consolidated, medium grained, abundant shells	Same as above	Same as above, add clay (15%), very pale orange (10YR 8/2), low porosity, high plasticity	Limestone(50%), very pale orange (10YR 8/2), moderate porosity, poorly to moderately consolidated, fine to medium grained; clay (50%), yellowish gray (5Y 8/1), high plasticity, low porosity	Limestone(50%), very pale orange (10YR 8/2), moderate porosity, poorly to moderately consolidated, fine to medium grained; clay (50%), yellowish gray (5Y 8/1), high plasticity, low porosity
780	790	Same as above, limestone is fine to medium grained	Same as above, decrease limestone to 90%, increase clay to 10%	Clay, very pale orange (10YR 8/2), low porosity, high plasticity	Same as above	Same as above
790	800	Same as above	Same as above	Clay, light olive gray (5Y 6/1), low porosity, high plasticity	Same as above	Same as above
800	810	Limestone (90%), yellowish gray (5Y 8/1), fine grained, poorly consolidated, medium porosity; clay (10%), light greenish gray (5G 8/1), low porosity, low plasticity, phosphatic	Same as above	Limestone, pale yellowish brown (10YR 6/2), low porosity, very well consolidated, very fine grained		Same as above
810	820	Same as above, increase clay to 20%, decrease limestone to 80%	Same as above, decrease limestone to 80%, increase clay to 20%	Clay, yellowish gray (5Y 8/1), high plasticity, low porosity		
820	830	Limestone, pale yellowish brown (10YR 6/2), low porosity, very well consolidated, very fine grained	Same as above, decrease limestone to 50%, increase clay to 50%	Same as above		

Table B-1 (continued)
Fort Myers Brackish Water Wellfield Lithologies

Depth (feet bls)		Lithologic Descriptions				
From	To	Well P-3	Well P-4	Well P-5	Well P-6	Well P-7
830	840	Clay, yellowish gray (5Y 8/1), high plasticity, low porosity	Clay, yellowish gray (5Y 8/1), low porosity, low plasticity			
840	850	Same as above, decrease clay to 80%, add dolomite (20%), pale yellowish brown (10YR 6/2), low porosity, very well consolidated, very fine grained	Limestone, low porosity, well consolidated			
850	860	Same as above	White limestone (80%), medium porosity, poorly consolidated, yellowish gray clay (20%)			
860	870	Clay, olive gray (5Y 3/2), high plasticity, low porosity	Same as above, limestone (60%), clay (40%)			
870	880	Limestone (50%), yellowish gray (5Y 8/1), poorly consolidated, moderate porosity, fine grained; clay (25%), yellowish gray (5Y 8/1), high plasticity, low porosity; dolomite (25%), pale yellowish brown (10YR 6/2), low porosity, very well consolidated, very fine grained	Limestone (50%), yellowish gray (5Y 8/1), poorly consolidated, moderate porosity, fine grained; clay (50%), yellowish gray (5Y 8/1), high plasticity, low porosity;			
880	890	Limestone, white (N9), poorly consolidated, high porosity, fine grained	Same as above			
890	894	Same as above	Same as above			

APPENDIX C

Summary of Construction Activities

**City of Fort Myers Membrane Water Treatment Plant
Production Well P-3
Summary of Construction Activities**

Date	Milestone
5/15/00	Began drilling 12.25-inch diameter pilot hole. Completed drilling pilot hole to a depth of 100 feet bls. Conducted geophysical logging. Logs conducted include caliper, natural gamma ray, spontaneous potential, and long & short normal electric resistivity.
5/16/00	Reamed pilot hole to a nominal 30-inch diameter to a depth of 97 feet bls. Conducted caliper geophysical logging. Installed 24-inch .375-inch wall thickness steel casing to a depth of 90 feet bls. Completed 1st stage of cementing 24-inch casing.
5/17/00	Completed 2nd and final stage of cementing 24-inch steel casing to a depth of 90 feet bls.
5/18/00	Began drilling 12.25-inch diameter pilot hole at a depth of 90 feet bls.
5/19/00	Completed pilot hole drilling to a depth of 552 feet bls. Conducted geophysical logging. Logs conducted are caliper, natural gamma ray, spontaneous potential, and long & short normal electric resistivity.
5/22/00	Began reaming the pilot hole to a nominal 24-inch diameter.
5/24/00	Completed reaming the pilot hole to a depth of 515 feet bls.
5/25/00	Conducted caliper geophysical logging. Installed 16-inch PVC casing to a depth of 510 feet bls. Completed 1st stage of cementing casing.
5/26/00	Completed 2nd stage of cementing casing.
5/27/00	Completed 3rd and final stage of cementing the 16-inch PVC casing to a depth of 510 feet bls.
6/1/00	Drilled out cement from inside the 16-inch PVC casing to a depth of 560 feet bls.
6/2/00	Begin drilling 8-inch diameter pilot hole at depth of 560 feet bls.
6/6/00	Completed drilling the 8-inch diameter pilot hole to a depth of 894 feet bls.
6/12/00	Conducted geophysical logging under static conditions. Logs conducted include caliper, natural gamma ray, spontaneous potential, long & short normal electric resistivity, fluid temperature, fluid resistivity and flow. Installed test pump at depth of 80 feet bls. Conducted geophysical logging under dynamic conditions at 520 gpm. Logs conducted include fluid temperature, fluid resistivity, and flow. Test pump removed.
6/13/00	Installed packer at depth of 820 feet bls.
6/14/00	Conducted main pump test on zone below packer at 8 gpm.
6/15/00	Backplugged pilot hole with cement from 894 feet bls to 836 feet bls.
6/16/00	Began reaming pilot hole to a nominal 14-inch diameter at a depth of 836 feet bls.
6/21/00	Completed reaming pilot hole to a depth of 836 feet bls. Conducted geophysical logging. Logs conducted include caliper, natural gamma ray, and video.

bls = below land surface

**City of Fort Myers Membrane Water Treatment Plant
Production Well P-4
Summary of Construction Activities**

Date	Milestone
5/15/00	Began drilling 8-inch diameter pilot hole. Completed drilling pilot hole to a depth of 100 feet bls. Conducted geophysical logging. Logs conducted include caliper, natural gamma ray, spontaneous potential, and long & short normal electric resistivity
5/16/00	Reamed pilot hole to a nominal 30-inch diameter to a depth of 94 feet bls. Conducted caliper geophysical logging. Installed 24-inch .375-inch wall thickness steel casing to a depth of 90 feet bls. Completed 1st stage of cementing 24-inch casing.
5/17/00	Completed 2nd and final stage of cementing 24-inch steel casing to a depth of 90 feet bls.
5/18/00	Began drilling 8-inch diameter pilot hole at a depth of 90 feet bls.
5/19/00	Completed pilot hole drilling to a depth of 562 feet bls. Conducted geophysical logging. Logs conducted are caliper, natural gamma ray, spontaneous potential, and long & short normal electric resistivity.
5/22/00	Began reaming the pilot hole to a nominal 24-inch diameter.
5/24/00	Completed reaming the pilot hole to a depth of 515 feet bls.
5/26/00	Completed reaming the pilot hole to a depth of 518 feet bls. Installed cement bridge plug from 520 feet to 515 feet bls.
6/1/00	Conducted caliper geophysical logging. Installed 16-inch PVC casing to a depth of 510 feet bls. Completed 1st stage of cementing casing.
6/2/00	Completed 2nd stage of cementing casing.
6/5/00	Completed 3rd and final stage of cementing the 16-inch PVC casing to a depth of 510 feet bls.
6/6/00	Drilled out cement from inside the 16-inch PVC casing and began drilling 8-inch diameter pilot hole to a depth of 563 feet bls.
6/9/00	Completed drilling the 8-inch diameter pilot hole to a depth of 895 feet bls.
6/14/00	Conducted geophysical logging under static conditions. Logs conducted include caliper, natural gamma ray, spontaneous potential, long & short normal electric resistivity, fluid temperature, fluid resistivity and flow. Conducted geophysical logging under dynamic conditions (630 gpm). Logs conducted include fluid temperature, fluid resistivity, and flow.
6/15/00	Backplugged pilot hole with cement from 895 feet bls to 825 feet bls.
6/19/00	Began reaming pilot hole to a nominal 14-inch diameter at a depth of 540 feet bls.
6/20/00	Completed reaming pilot hole to a depth of 825 feet bls.
6/21/00	Conducted geophysical logging. Logs conducted include caliper, natural gamma ray and video.

bls = below land surface

**City of Fort Myers Membrane Water Treatment Plant
Production Well P-5
Summary of Construction Activities**

Date	Milestone
7/3/00	Began drilling 8-inch diameter pilot hole. Completed drilling pilot hole to a depth of 110 feet bls. Conducted geophysical logging. Logs conducted include caliper, natural gamma ray, spontaneous potential, and long & short normal electric resistivity
7/5/00	Reamed pilot hole to a nominal 30-inch diameter to a depth of 94 feet bls.
7/6/00	Conducted caliper geophysical logging. Installed 24-inch .375-inch wall thickness steel casing to a depth of 92 feet bls. Completed 1st stage of cementing 24-inch casing. Completed 2nd and final stage of cementing 24-inch steel casing to a depth of 90 feet bls.
7/7/00	Completed 2nd and final stage of cementing 24-inch steel casing to a depth of 92 feet bls.
7/10/00	Began drilling 8-inch diameter pilot hole at a depth of 97 feet bls.
7/11/00	Completed pilot hole drilling to a depth of 523 feet bls.
7/12/00	Conducted geophysical logging. Logs conducted are caliper, natural gamma ray, spontaneous potential, and long & short normal electric resistivity.
7/13/00	Began reaming the pilot hole to a nominal 24-inch diameter.
7/17/01	Completed reaming the pilot hole to a depth of 485 feet bls.
7/18/00	Conducted caliper geophysical logging. Installed 16-inch PVC casing to a depth of 480 feet bls. Completed 1st stage of cementing casing.
7/19/00	Completed 2nd stage of cementing casing.
7/20/00	Completed 3rd and final stage of cementing the 16-inch PVC casing to a depth of 510 feet bls.
7/24/00	Drilled out cement from inside the 16-inch PVC casing and began drilling 8-inch diameter pilot hole to a depth of 616 feet bls.
7/25/00	Completed drilling the 8-inch diameter pilot hole to a depth of 832 feet bls.
7/27/00	Conducted geophysical logging under static conditions. Logs conducted include caliper, natural gamma ray, spontaneous potential, long & short normal electric resistivity, fluid temperature, fluid resistivity and flow. Conducted geophysical logging under dynamic conditions (655 gpm). Logs conducted include fluid temperature, fluid resistivity, and flow.
7/28/00	Began reaming pilot hole to a nominal 14-inch diameter at a depth of 485 feet bls.
7/31/00	Completed reaming pilot hole to a depth of 832 feet bls.
8/1/00	Conducted geophysical logging. Logs conducted include caliper, natural gamma ray and video.

bls = below land surface

**City of Fort Myers Membrane Water Treatment Plant
Production Well P-6
Summary of Construction Activities**

Date	Milestone
8/10/00	Began drilling 8-inch diameter pilot hole. Completed drilling pilot hole to a depth of 92 feet bls. Conducted geophysical logging. Logs conducted include caliper, natural gamma ray, spontaneous potential, and long & short normal electric resistivity
8/16/00	Reamed pilot hole to a nominal 32-inch diameter to a depth of 92 feet bls. Conducted caliper geophysical logging. Installed 32-inch .375-inch wall thickness steel casing to a depth of 90 feet bls. Completed 1st stage of cementing 32-inch casing.
8/17/00	Completed 2nd and final stage of cementing 32-inch steel casing to a depth of 90 feet bls.
8/18/00	Began drilling 8-inch diameter pilot hole at a depth of 90 feet bls.
8/29/00	Completed pilot hole drilling to a depth of 562 feet bls. Conducted geophysical logging. Logs conducted are caliper, natural gamma ray, spontaneous potential, and long & short normal electric resistivity.
8/30/00	Began reaming the pilot hole to a nominal 26-inch diameter.
9/5/00	Completed reaming the pilot hole to a depth of 448 feet bls. Conducted caliper geophysical logging. Installed 16-inch PVC casing to a depth of 445 feet bls. Completed 1st stage of cementing casing.
9/6/00	Completed 2nd stage of cementing casing.
9/7/00	Completed 3rd and final stage of cementing the 16-inch PVC casing to a depth of 510 feet bls.
9/11/00	Drilled out cement from inside the 16-inch PVC casing and began drilling 8-inch diameter pilot hole to a depth of 583 feet bls.
9/12/00	Completed drilling the 8-inch diameter pilot hole to a depth of 805 feet bls.
9/14/00	Conducted geophysical logging under static conditions. Logs conducted include caliper, natural gamma ray, spontaneous potential, long & short normal electric resistivity, fluid temperature, fluid resistivity and flow. Conducted geophysical logging under dynamic conditions (826 gpm). Logs conducted include fluid temperature, fluid resistivity, and flow.
9/15/00	Began reaming pilot hole to a nominal 14-inch diameter at a depth of 445 feet bls.
9/18/00	Completed reaming pilot hole to a depth of 825 feet bls.
9/19/00	Conducted geophysical logging. Logs conducted include caliper, natural gamma ray and video.

bls = below land surface

**City of Fort Myers Membrane Water Treatment Plant
Production Well P-7
Summary of Construction Activities**

Date	Milestone
7/7/00	Began drilling 8-inch diameter pilot hole. Completed drilling pilot hole to a depth of 93 feet bls. Conducted geophysical logging. Logs conducted include caliper, natural gamma ray, spontaneous potential, and long & short normal electric resistivity
7/10/00	Conducted geophysical logging. Logs conducted include caliper, natural gamma ray, spontaneous potential, and long & short normal electric resistivity
7/19/00	Reamed pilot hole to a nominal 32-inch diameter to a depth of 77 feet bls. Conducted caliper geophysical logging. Installed 24-inch .375-inch wall thickness steel casing to a depth of 90 feet bls. Completed 1st stage of cementing 24-inch casing.
7/20/00	Conducted caliper geophysical logging. Installed 26-inch .375-inch wall thickness steel casing to a depth of 75 feet bls. Completed 1st stage of cementing 26-inch casing.
7/21/00	Began drilling 8-inch diameter pilot hole at a depth of 80 feet bls.
7/26/00	Completed pilot hole drilling to a depth of 470 feet bls. Conducted geophysical logging. Logs conducted are caliper, natural gamma ray, spontaneous potential, and long & short normal electric resistivity.
7/27/00	Backfilled pilot hole to 453 feet bls.
7/28/00	Began reaming the pilot hole to a nominal 26-inch diameter.
8/2/00	Completed reaming the pilot hole to a depth of 450 feet bls.
8/3/00	Conducted caliper geophysical logging. Installed 16-inch PVC casing to a depth of 445 feet bls. Completed 1st stage of cementing casing.
8/4/00	Completed 2nd stage of cementing casing.
8/5/00	Completed 3rd and final stage of cementing the 16-inch PVC casing to a depth of 445 feet bls.
8/9/00	Drilled out cement from inside the 16-inch PVC casing and began drilling 8-inch diameter pilot hole to a depth of 502 feet bls.
8/15/00	Completed drilling the 8-inch diameter pilot hole to a depth of 800 feet bls.
8/17/00	Conducted geophysical logging under static conditions. Logs conducted include caliper, natural gamma ray, spontaneous potential, long & short normal electric resistivity, fluid temperature, fluid resistivity and flow. Conducted geophysical logging under dynamic conditions (750 gpm). Logs conducted include fluid temperature, fluid resistivity, and flow:-
8/18/00	Began reaming pilot hole to a nominal 14-inch diameter at a depth of 450 feet bls.
8/21/00	Completed reaming pilot hole to a depth of 825 feet bls.
8/23/00	Conducted geophysical logging. Logs conducted include caliper, natural gamma ray and video.

bls = below land surface

APPENDIX D

Daily Construction Reports

APPENDIX D

Daily Construction Reports

APPENDIX D.1

Well P-1 Daily Construction Reports

CH2M HILL DAILY SUMMARY

Day/Date: 8-29-00
Project No.: 157775.A1.03
Client: City of Ft. Myers
Contractor: Well Water Systems, Inc.
Well No.: P-1
Weather: Sunny, 90 degrees F

Activity: Backfill
Starting Depth: N/A

Bit Size: N/A
Ending Depth: N/A

<u>Time</u>	<u>Description</u>
0700	R. Dean onsite. Driller begins placing sand in well to backfill to 470 feet bls.

Recorded By:

Randy Dean/CH2M HILL

Date : 8/29/00

CH2M HILL DAILY SUMMARY

Day/Date: 8-30-00
Project No.: 157775.A1.03
Client: City of Ft. Myers
Contractor: Well Water Systems, Inc.
Well No.: P-1
Weather: Sunny, 90 degrees F

Activity: Sand tag
Starting Depth: N/A

Bit Size: N/A
Ending Depth: N/A

<u>Time</u>	<u>Description</u>
0700	R. Dean onsite. Driller is preparing to tag sand.
1400	Driller states that all activities are complete today.

Recorded By: Randy Dean/CH2M HILL

Date : 8/30/00

CH2M HILL DAILY SUMMARY

Day/Date: 8-31-00
Project No.: 157775.A1.03
Client: City of Ft. Myers
Contractor: Well Water Systems, Inc.
Well No.: P-1
Weather: Sunny, 90 degrees F

Activity: Sand tag
Starting Depth: N/A

Bit Size: N/A
Ending Depth: N/A

<u>Time</u>	<u>Description</u>
0700	R. Dean onsite. Driller is preparing to tag sand.
1045	Driller tags sand at 368 feet bls.
1900	Driller has removed sand to a depth of 443 feet bls. Target depth is 470 feet bls. Driller has completed activities today. R. Dean leaves site for the day.

Recorded By: Randy Dean/CH2M HILL

Date : 8/31/00

CH2M HILL DAILY SUMMARY

Day/Date: 09-01-00
Project No.: 157775.A1.03
Client: City of Ft. Myers
Contractor: Well Water Systems, Inc.
Well No.: P-1
Weather: Sunny, 90 degrees F

Activity: Sand tag, pump cement tag
Starting Depth: N/A

Bit Size: N/A
Ending Depth: N/A

<u>Time</u>	<u>Description</u>
0700	R. Dean onsite. Driller is preparing to remove sand.
0930	Driller tags sand at 470 feet bls. Driller is preparing to pump 10 bags neat cement to create 5 foot cement plug from 465 to 470 feet bls.
1025	Pumped 10 bags neat cement. All activities complete today.

Recorded By: Randy Dean/CH2M HILL

Date : 09/01/00

CH2M HILL DAILY SUMMARY

Day/Date: 09-06-00
Project No.: 157775.A1.03
Client: City of Ft. Myers
Contractor: Well Water Systems, Inc.
Well No.: P-1
Weather: Sunny, 90 degrees F

Activity: Casing Installation
Starting Depth: N/A

Bit Size: N/A
Ending Depth: N/A

<u>Time</u>	<u>Description</u>
0700	R. Dean onsite.
0830	Driller begins installing 464 feet PVC casing.
1200	Casing installed to 464 feet bls.
1210	Begin mixing batch 1 of 7 of 4% bentonite.
1215	Pump batch #1 (30 bags)
1231	Pump batch #2 (30 bags)
1244	Pump batch #3 (30 bags)
1258	Pump batch #4 (30 bags)
1313	Pump batch #5 (30 bags)
1328	Pump batch #6 (30 bags)
1340	Pump batch #7 (30 bags)
	No further work on this site today

Recorded By: Randy Dean/CH2M HILL

Date : 09/06/00

CH2M HILL DAILY SUMMARY

Day/Date: 09-07-00
Project No.: 157775.A1.03
Client: City of Ft. Myers
Contractor: Well Water Systems, Inc.
Well No.: P-1
Weather: Sunny, 90 degrees F

Activity: Cementing
Starting Depth: N/A

Bit Size: N/A
Ending Depth: N/A

<u>Time</u>	<u>Description</u>
0700	R. Dean onsite.
0830	Driller tags inside casing at 405 feet bls'.
1100	Driller tags annular zone at 306 feet bls.
1225	Pump batch #1 of 4 of 4% bentonite (30 bags)
1246	Pump batch #2 of 4 of 4% bentonite (30 bags)
1306	Pump batch #3 of 4 of 4% bentonite (30 bags)
1323	Pump batch #4 of 4 of 4% bentonite (30 bags)
1500	R. Dean leaves site for the day.

Recorded By: Randy Dean/CH2M HILL

Date : 09/07/00

CH2M HILL DAILY SUMMARY

Day/Date: 09-08-00
Project No.: 157775.A1.03
Client: City of Ft. Myers
Contractor: Well Water Systems, Inc.
Well No.: P-1
Weather: Sunny, 90 degrees F

Activity: Cementing
Starting Depth: N/A

Bit Size: N/A
Ending Depth: N/A

<u>Time</u>	<u>Description</u>
0700	R. Dean onsite.
0715	Driller tags annular zone at 157 feet bls.
0822	Pump batch #1 of 5 of 4% bentonite (30 bags)
0839	Pump batch #2 of 5 of 4% bentonite (30 bags)
0900	Pump batch #3 of 5 of 4% bentonite (30 bags)
0930	Pump batch #4 of 5 of 4% bentonite (30 bags)
0948	Pump batch #5 of 5 of 4% bentonite (30 bags)

Recorded By: Randy Dean/CH2M HILL

Date : 09/08/00

CH2M HILL DAILY SUMMARY

Day/Date: 09-11-00
Project No.: 157775.A1.03
Client: City of Ft. Myers
Contractor: Well Water Systems, Inc.
Well No.: P-1
Weather: Sunny, 90 degrees F

Activity: Removing Sand Backfill
Starting Depth: N/A

Bit Size: N/A
Ending Depth: N/A

<u>Time</u>	<u>Description</u>
0700	R. Dean onsite.
0830	Driller installs casing dummy for alignment test to 310 feet bls.
1037	Drilling reaches 355 feet bls.
1400	Drilling reaches 408 feet bls.
1650	Drilling reaches 454 feet bls.
1753	Drilling reaches 470 feet bls.
	All activities complete today.

Recorded By: Randy Dean/CH2M HILL

Date : 09/11/00

CH2M HILL DAILY SUMMARY

Day/Date: 09-12-00
Project No.: 157775.A1.03
Client: City of Ft. Myers
Contractor: Well Water Systems, Inc.
Well No.: P-1
Weather: Sunny, 90 degrees F

Activity: Removing Sand Backfill
Starting Depth: N/A

Bit Size: N/A
Ending Depth: N/A

<u>Time</u>	<u>Description</u>
0700	R. Dean onsite.
0835	Driller reaches 485 feet of removing sand backfill.
1345	Driller reaches 560 feet bls.
1700	Driller informs R. Dean that rig has broken down. All work complete here until further notice.

Recorded By: Randy Dean/CH2M HILL

Date : 09/12/00

CH2M HILL DAILY SUMMARY

Day/Date: 09-18-00
Project No.: 157775.A1.03
Client: City of Ft. Myers
Contractor: Well Water Systems, Inc.
Well No.: P-1
Weather: Sunny, 90 degrees F

Activity: Removing Sand Backfill
Starting Depth: N/A

Bit Size: N/A
Ending Depth: N/A

<u>Time</u>	<u>Description</u>
0700	R. Dean onsite. Sand removal has reached 600 feet bls.
1800	Driller states there is a problem with the bit. All work completed on this site today.

Recorded By: Randy Dean/CH2M HILL

Date : 09/18/00

CH2M HILL DAILY SUMMARY

Day/Date: 09-21-00
Project No.: 157775.A1.03
Client: City of Ft. Myers
Contractor: Well Water Systems, Inc.
Well No.: P-1
Weather: Sunny, 90 degrees F

Activity: Well Development
Starting Depth: N/A

Bit Size: N/A
Ending Depth: N/A

<u>Time</u>	<u>Description</u>
0700	Begin reverse-air development of P-1 at 775 feet bls.
0830	R. Dean leaves site for Winkler Avenue site.
0930	Development completed. Driller is tripping out of hole.

Recorded By: Randy Dean/CH2M HILL

Date : 09/21/00

APPENDIX D.2

Well P-2 Daily Construction Reports

CH2M HILL DAILY SUMMARY

Day/Date: Wednesday/8-02-00
Project No.: 157775.A1.03
Client: City of Ft. Myers
Contractor: Well Water Systems, Inc.
Well No.: P-2
Weather: Partly Cloudy, 93 degrees F

Activity: Acidization
Starting Depth: N/A

Bit Size: N/A
Ending Depth: N/A

<u>Time</u>	<u>Description</u>
0700	R. Dean arrives onsite. Driller is onsite.
0915	4,000 gallons 32% HCl arrives onsite.
0920	Begin pumping water into well.
0935	Begin pumping acid at 100 gpm.
0945	Begin adding water at 70 gpm.
0958	Pressure = 10 psi.
1015	Pumping acid complete. Begin water chase down water line and acid line at 130 gpm.
1047	End pumping water. Chase with 4050 gallons water.

Recorded By: Randy Dean/CH2M HILL

Date : 8/02/00

CH2M HILL DAILY SUMMARY

Day/Date: Thursday/8-03-00
Project No.: 157775.A1.03
Client: City of Ft. Myers
Contractor: Well Water Systems, Inc.
Well No.: P-2
Weather: Partly Cloudy, 93 degrees F

Activity: Acid removal
Starting Depth: N/A

Bit Size: N/A
Ending Depth: N/A

<u>Time</u>	<u>Description</u>
0700	R. Dean arrives onsite. Driller is onsite.
0800	Driller is waiting for tankers to arrive onsite.
0830	Tankers arrive onsite. Wellhead reads 9 psi.
0915	6,000 gallons loaded in tanker. 4.5 psi.
1000	12,000 gallons pumped. Driller states that there is too much water coming from the well to adequately control. Driller is making arrangements to control flow prior to well development.

Recorded By: Randy Dean/CH2M HILL

Date : 8/03/00

CH2M HILL DAILY SUMMARY

Day/Date: Friday/8-04-00
Project No.: 157775.A1.03
Client: City of Ft. Myers
Contractor: Well Water Systems, Inc.
Well No.: P-2
Weather: Partly Cloudy, 93 degrees F

Activity: Well development
Starting Depth: N/A

Bit Size: N/A
Ending Depth: N/A

<u>Time</u>	<u>Description</u>
0700	R. Dean arrives onsite. Driller is onsite.
0900	Driller is setting up discharge system for development. Driller decides to let well flow to allow chloride concentration to return to background levels.

Recorded By:

Randy Dean/CH2M HILL

Date : 8/04/00

APPENDIX D.3

Well P-3 Daily Construction Reports

CH2M HILL DAILY SUMMARY

Day/Date: Monday/5-15-00
Project No.: 157775.A1.03
Client: City of Ft. Myers
Contractor: Well Water Systems, Inc.
Well No.: P-3
Weather: Sunny, 90 degrees F

Activity: Drilling Pilot Hole, Logging, Reaming
Starting Depth: 0 feet bls

Bit Size: 12.25-inches, 29-inches
Ending Depth: 100 feet bls

<u>Time</u>	<u>Description</u>
0655	Randy Dean (Site Engineer) of CH2M HILL arrives onsite. Well Water Systems (Driller) is already onsite and is preparing to begin pilot hole drilling.
0700	Pilot hole drilling begins. Mike Hollace is the Driller. Bruce Balmer is the Project Drilling Supervisor.
0750	Drilling reaches 17ft.
0845	Drilling reaches 35 ft.
0945	Drilling reaches 65 ft.
1040	Drilling reaches 100ft.
1045	Southern Resources Exploration (Logger) arrives onsite.
1145	Logging begins on P-3. Logs to be conducted are LSN, SP Electric, Gamma, and Caliper.
1300	Begin reaming P-3 to 30-inch diameter for surface casing.
1600	Reaming complete to 20 ft. R. Dean leaves site for the day.

Recorded By: R. Dean/CH2M HILL

Date : 5/15/00

CH2M HILL DAILY SUMMARY

Day/Date: Tuesday/5-16-00
Project No.: 157775.A1.03
Client: City of Ft. Myers
Contractor: Well Water Systems, Inc.
Well No.: P-3
Weather: Sunny, 90 degrees F

Activity: Reaming Pilot Hole, Installing Surface Casing **Bit Size:** 29-inches
Starting Depth: 20 feet bls **Ending Depth:** 97 feet bls

<u>Time</u>	<u>Description</u>
0700	Randy Dean arrives onsite. Driller is already onsite and is pilot hole reaming is beginning.
0750	Trouble with swivel on drill rig. Drilling stops.
0850	Reaming reaches 43 ft.
0930	Southern Resources Exploration arrives onsite. Reaming continues.
1300	Reaming reaches approximately 55 ft.
1350	Reaming reaches depth of 97 feet bls. Driller is tripping out of hole for logging.
1430	Caliper logs are run on reamed hole.
1615	Beginning to install surface casing.
1715	90 feet of casing installed in hole. Driller is preparing for pressure grout.
1820	Preparing first batch of neat cement. 40 bags of neat cement will be pressure grouted in each batch.
1840	Second batch of cement is pressure grouted
1850	Third batch of cement is pressure grouted
1905	Fourth batch of cement is pressure grouted
1922	Fifth batch of cement is pressure grouted
1947	Sixth batch of cement is pressure grouted. Total of 240 bags of neat cement is cemented into casing. No returns noted at surface. Well will be left alone overnight and cemented tomorrow.
2000	R Dean leaves site for the day. Driller is cleaning site and preparing to leave for the day

Recorded By: R. Dean/CH2M HILL

Date : 5/16.0

CH2M HILL DAILY SUMMARY

Day/Date: Wednesday/5-17-00
Project No.: 157775.A1.03
Client: City of Ft. Myers
Contractor: Well Water Systems, Inc.
Well No.: P-3
Weather: Sunny, 90 degrees F

Activity: Tag Cement Depth, Cement Surface Casing
Starting Depth: 32 feet bls

Bit Size: NA
Ending Depth: 0 feet bls

<u>Time</u>	<u>Description</u>
0655	Randy Dean arrives onsite. Driller is already onsite.
0715	Tag on inside of casing is at 88 feet bls. Tags in well annulus at 32 feet bls on east side of well and 30 feet bls on west side. Thoretical value for cement needed is 30 bags of 6% bentonite grout to bring cement to land surface.
0825	Finish cementing with 30 bags 6% bentonite. Strong returns noted at surface. Chased with 25 gallons of water.
0930	Driller to remain onsite today and prepare for pilot hole drilling.
1000	R. Dean leaves site for the day.

Recorded By: R. Dean/CH2M HILL

Date : 5/17/00

CH2M HILL DAILY SUMMARY

Day/Date: Thursday/5-18-00
Project No.: 157775.A1.03
Client: City of Ft. Myers
Contractor: Well Water Systems, Inc.
Well No.: P-3
Weather: Sunny, 90 degrees F

Activity: Pilot Hole Drilling
Starting Depth: 88 feet bls

Bit Size: 12.25
Ending Depth: 465 feet bls

<u>Time</u>	<u>Description</u>
0655	Randy Dean arrives onsite. Driller is arriving onsite.
0700	Driller is waiting for mud cuttings to be tankered offsite before pilot hole drilling begins today.
0720	R. Dean instructs B. Balmer to drill pilot hole to 480 feet bls on both wells P-3 and P-4.
0725	First drill rod in hole.
0930	Pilot hole to 124 feet bls.
1150	Pilot hole to 200 feet bls.
1305	Pilot hole to 258 feet bls.
1626	Pilot hole to 366 feet bls.
1734	Pilot hole to 396 feet bls.
1906	Pilot hole to 458 feet bls. R. Dean notifies Driller that pilot hole to be drilled to 485 feet bls to allow for logging to 480 feet bls.
1955	Pilot hole drilling stops for day at 465 feet bls.
2000	R. Dean leaves site for the day. Driller will leave site shortly.

Recorded By: R. Dean/CH2M HILL

Date : 5/18/00

CH2M HILL DAILY SUMMARY

Day/Date: Friday/5-19-00
Project No.: 157775.A1.03
Client: City of Ft. Myers
Contractor: Well Water Systems, Inc.
Well No.: P-3
Weather: Sunny, 90 degrees F

Activity: Pilot Hole Drilling. Logging
Starting Depth: 465 feet bls

Bit Size: 12.25
Ending Depth: 552 feet bls

<u>Time</u>	<u>Description</u>
0755	Randy Dean arrives onsite. Driller is already onsite and tripping drill rods into hole. Driller will recirculate drilling mud and resume pilot hole drilling shortly.
0850	Pilot hole to 470 feet bls.
0954	Pilot hole to 475 feet bls. Drilling is very slow.
1000	John Vincent and Steve Miller of MV Geophysical (Loggers) arrive onsite.
1010	Drilling reaches 476 feet bls. Driller notes increase in drilling speed.
1025	Driller states he is drilling through limestone. No cuttings returns noted yet.
1035	R. Dean instructs Driller to continue pilot hole to 500 feet bls.
1045	Pilot hole to 490 feet bls.
1100	Bill Beddow/CH2M HILL arrives onsite. B. Beddow instructs Driller to complete current rod in hole to bring total depth to 521 feet bls.
1140	B. Beddow instructs Driller to add drill rod to bring depth to 550 feet bls.
1230	Pilot hole drilling stops at depth of 552.32 feet bls.
1315	Geophysical logging begins. Logs to be run are LSN, SP Electric, Gamma, and XY Caliper.
1400	Logger tags bottom of hole at 549.5 feet bls.
1430	Logger is done on this site. Driller will prepare to begin reaming Monday 5/22/00.

Recorded By: R. Dean/CH2M HILL

Date : 5/19/00

CH2M HILL DAILY SUMMARY

Day/Date: Monday/5-22-00
Project No.: 157775.A1.03
Client: City of Ft. Myers
Contractor: Well Water Systems, Inc.
Well No.: P-3
Weather: Sunny, 90 degrees F

Activity: Reaming

Bit Size: 22.5-inches

Starting Depth: 97 feet bls

Ending Depth: 330 feet bls

<u>Time</u>	<u>Description</u>
0655	R. Dean arrives onsite. Driller is onsite and preparing to begin reaming pilot hole with a 22.5-inch bit.
1130	Reamed hole to 195 feet bls. Reaming has stopped because mud tank is full.
1145	Tanker onsite to empty mud tank.
1750	Driller has finished reaming for the day and is preparing to leave the site for the day. Reaming depth of 330 feet bls reached.

Recorded By: R. Dean/CH2M HILL

Date : 5/22/00

CH2M HILL DAILY SUMMARY

Day/Date: Tuesday/5-23-00
Project No.: 157775.A1.03
Client: City of Ft. Myers
Contractor: Well Water Systems, Inc.
Well No.: P-3
Weather: Sunny, 90 degrees F

Activity: Reaming
Starting Depth: 330 feet bls

Bit Size: 22.5-inches
Ending Depth: feet bls

<u>Time</u>	<u>Description</u>
0730	R. Dean arrives onsite. Driller is tripping into hole to continue reaming.
0915	Reaming continues. Depth is approximately 348 feet bls.
1045	Brief rainfall at site.
1125	Driller notifies R. Dean that the universal joint has failed on the rig. Reaming will stop until it can be fixed

Recorded By: R. Dean/CH2M HILL

Date : 5/23/00

CH2M HILL DAILY SUMMARY

Day/Date: Wednesday/5-24-00
Project No.: 157775.A1.03
Client: City of Ft. Myers
Contractor: Well Water Systems, Inc.
Well No.: P-3
Weather: Sunny, 90 degrees F

Activity: Reaming
Starting Depth: 460 feet bls

Bit Size: 22.5-inches
Ending Depth: 515 feet bls

<u>Time</u>	<u>Description</u>
0715	R. Dean arrives onsite. Driller is tripping into hole to continue reaming. Reaming depth at end of yesterday was 460 feet bls. Driller noted there was a hard section to get through at approximately 400 feet bls. He put some extra weight on the bit to get it through.
0740	Reaming resumes. Driller plans to ream to 515 feet bls today. Driller will make wiper pass using single drill rods today. Hole will be geophysically logged with gamma and caliper logs tomorrow. Casing is planned to follow logging tomorrow.
0905	Reaming depth to 465 feet bls.
1030	R. Dean discusses cementing plan with B. Balmer. B. Balmer to provide detailed cementing plan indicating theoretical volume and lift calculations, mud and cement weights, pressure required to lift cement in annulus, and heat of hydration/collapse pressure calculations. R. Dean notifies B. Balmer that Contractor is responsible for contacting the required regulatory agencies (Lee County Health Department, FDEP, SFWMD) to notify them of plans to cement well tomorrow.
1300	Reaming depth to 475 feet bls.
1530	R. Dean leaves site for the day. Driller will continue to ream hole to total depth of 515 feet bls.

Recorded By: R. Dean/CH2M HILL

Date : 5/24/00

CH2M HILL DAILY SUMMARY

Day/Date: Thursday/5-25-00
Project No.: 157775.A1.03
Client: City of Ft. Myers
Contractor: Well Water Systems, Inc.
Well No.: P-3
Weather: Sunny, 90 degrees F

Activity: Installing casing and cement grout
Starting Depth: 0 feet bls

Bit Size: NA
Ending Depth: 515 feet bls

<u>Time</u>	<u>Description</u>
0710	R. Dean arrives onsite. Driller is onsite and circulating mud in hole.
0715	B. Balmer contacted B. Kohlmeier to verify that the required agencies were contacted regarding the cementing activities today. B. Kohlmeier verifies.
1037	Begin installing 510 feet of 16" SDR-17 PVC casing.
1300	PVC casing installed into hole.
1415	Begin mixing first of 4 batches of neat cement.
1430	Begin pressure grouting first batch.
1447	Begin pressure grouting second batch.
1503	Begin pressure grouting third batch.
1520	Begin pressure grouting fourth batch.
1525	Total 4 batches neat cement, 120 bags pumped.
1600	R. Dean leaves site for the day.

Recorded By: R. Dean/CH2M HILL

Date : 5/25/00

CH2M HILL DAILY SUMMARY

Day/Date: Friday/5-26-00
Project No.: 157775.A1.03
Client: City of Ft. Myers
Contractor: Well Water Systems, Inc.
Well No.: P-3
Weather: Sunny, 90 degrees F

Activity: 2nd stage cement grout
Starting Depth: 243 feet bls

Bit Size: NA
Ending Depth: 32 feet bls

<u>Time</u>	<u>Description</u>
0700	R. Dean arrives onsite. Driller is onsite and preparing to tag inside of casing.
0705	Inside of casing tagged at 504 feet bls.
0725	R. Dean instructs B. Balmer to tag annulus on two sides.
1115	Four attempts were made to install tremmie for tag in annulus. Driller will try to "jet" through clay with tremmie pipe.
1210	Setting up for jetting.
1300	Tremmie pipe advanced ~6-inches in over 30 minutes. Bill Beddow of CH2M HILL decides to grout from top of cement.
1344	Tremmie pipe set at 235 feet bls. Tremmie advanced to 243 feet bls. Plan is to pump 200 bags neat cement to bring grout into surface casing.
1400	Andy Fanguaire of CH2M HILL arrives onsite.
1500	Pumping of 200 bags neat cement complete.
1545	R. Dean leaves site for the day.
1625	A. Fanguaire leaves site for the day.

Recorded By: R. Dean, A. Fanguaire/CH2M HILL

Date : 5/26/00

CH2M HILL DAILY SUMMARY

Day/Date: Saturday/5-27-00
Project No.: 157775.A1.03
Client: City of Ft. Myers
Contractor: Well Water Systems, Inc.
Well No.: P-3
Weather: Sunny, 90 degrees F

Activity: Cementing

Bit Size: N/A

Starting Depth: 510 feet bls

Ending Depth: 510 feet bls

<u>Time</u>	<u>Description</u>
0650	A. Fanguiare on-site. Driller on-site
0655	Driller tripping in tubing for tag.
0700	Tag depth – 37 ft bls
0705	Called B. Beddow – Driller will cement to surface level. Cement Plan: 40 bags neat, 208 gallons of water, no chase 5.22 gallons/sack, 1.18 ft ³ per sack, 1.05 sacks/foot x 40 = 42 bags Driller performing maintenance on truck.
0750	Begin mixing cement
0800	Begin pumping cement
0806	Finish pumping. To bring cement to surface level, ½ batch will be added.
0815	Begin pumping ½ batch.
0818	Pushing cement out of hole, stop pumping. Driller beginning clean-up.
0830	AF off-site for day

Recorded By: A. Fanguiare/CH2M HILL

Date : 5/27/00

CH2M HILL DAILY SUMMARY

Day/Date: Tuesday/5-30-00
Project No.: 157775.A1.03
Client: City of Ft. Myers
Contractor: Well Water Systems, Inc.
Well No.: P-3
Weather: Sunny, 90 degrees F

Activity: Clean-up/Equipment Fabrication
Starting Depth: 510 feet bls

Bit Size: N/A
Ending Depth: 510 feet bls

<u>Time</u>	<u>Description</u>
0655	A. Fanguiare on-site. Driller on-site, cleaning area around well.
1200	Driller manufacturing barrel tool to test straightness of casing.
1700	Driller continuing work on barrel tool. AF off-site for day.

Recorded By: A. Fanguiare/CH2M HILL

Date : 5/30/00

CH2M HILL DAILY SUMMARY

Day/Date: Wednesday/5-31-00
Project No.: 157775.A1.03
Client: City of Ft. Myers
Contractor: Well Water Systems, Inc.
Well No.: P-3
Weather: Sunny, 90 degrees F

Activity: **Bit Size:** N/A
Starting Depth: 510 feet bls **Ending Depth:** 510 feet bls

<u>Time</u>	<u>Description</u>
0630	A. Fanguiaire arrives on-site. Drillers on-site
0645	Lowering barrel into well. Barrel is 32' long, 12.75" OD. With sub, barrel is 33.65
0705	Barrel in well – TD 33.65
0737	First pipe in well – 59.16, TD 92.81
0742	Second pipe in well – 60.72, TD 153.53
0745	Third pipe in well – 62.14, TD 215.67
0805	Lowering Fourth pipe in well, encountered obstruction, cannot lower past 217 feet
0815	Removing pipe and barrel from well.
0840	Bobby from Well Water on-site.
0845	Pipe and barrel out of well.
0850	Driller measured and determined sub to be off by approx. ½ inch, beginning repairs.
0900	Running 12" drill bit at end of pipe into well.
0913	Approximately 240' in well, no obstructions.
0915	Approximately 300' in well, no obstructions. No apparent significant deviations.
0950	B. Beddow on-site.
1110	Repairs on barrel complete, lowering into well.
1120	Barrel in well.
1130	First pipe in well – 59.16, TD 92.81
1133	Second pipe in well – 60.72, TD 153.53
1136	Third pipe in well – 62.14, TD 215.67
1138	Lowering Fourth pipe in well, encountered obstruction, cannot lower past 217 feet
1140	Turning pipe 90° and attempting to lower. Unsuccessful.
1145	Removing pipe and barrel from well.
1207	Pipe and barrel out of well. B. Beddow agrees to allow Well Water to attempt with A 12" OD pipe. Driller will find pipe and bring to site.
1215	AF, B. Beddow off-site for lunch.;
1315	AF on-site. Driller has procured 12" OD pipe, 31' 11" long. Begin work on sub.
1435	Barrel work is complete, lowering barrel into well.

1445 Barrel in hole
1455 First pipe in well – 59.16, TD 92.81
1458 Second pipe in well – 60.72, TD 153.53
1501 Third pipe in well – 62.14, TD 215.67
1507 Fourth pipe in well -
1515 Fifth pipe in well, lowered to TD of 300'. No obstructions encountered.
Removing pipe and barrel from well.
1530 B. Beddow off-site for day
1545 Pipe and barrel out of well. Driller will clean up and begin pumping mud from well.
1730 AF off-site for day.

Recorded By: A. Fanguiaire/CH2M HILL

Date : 5/31/00

CH2M HILL DAILY SUMMARY

Day/Date: Thursday/6-1-00
Project No.: 157775.A1.03
Client: City of Ft. Myers
Contractor: Well Water Systems, Inc.
Well No.: P-3
Weather: Sunny, 90 degrees F

Activity: Reverse-air drilling
Starting Depth: 510 feet bls

Bit Size: 7.785"
Ending Depth: 550 feet bls

<u>Time</u>	<u>Description</u>
0700	R. Dean arrives onsite. Driller is onsite and is preparing for reverse-air drilling. Driller is trying to clean out hole.
1700	Driller has reached 550 feet bls. No formation water has been encountered. Driller will resume drilling tomorrow.

Recorded By: R. Dean /CH2M HILL

Date : 6/1/00

CH2M HILL DAILY SUMMARY

Day/Date: Friday/6-2-00
Project No.: 157775.A1.03 -
Client: City of Ft. Myers
Contractor: Well Water Systems, Inc.
Well No.: P-3
Weather: Sunny, 90 degrees F

Activity: Reverse-air drilling
Starting Depth: 550 feet bls

Bit Size: 7.785"
Ending Depth: 646 feet bls

<u>Time</u>	<u>Description</u>
0700	R. Dean arrives onsite. Driller is onsite and is preparing to continue reverse-air drilling.
0730	Driller states there is no formation water at 550 feet bls. R. Dean instructs Driller to continue drilling to 581 feet bls.
0930	Driller is preparing for specific capacity test.
1148	Begin specific capacity test at 581 feet bls. Static water level (WL) is 13.5 feet above land surface (als). Tank level is 33-inches.
1208	Test ends. Water sample collected. Cl = 960 mg/L, Conductivity=3780 umhos. Total drawdown=77.83 feet. Tank level-16". Tank is 149.6 gallons/inch depth. Specific capacity is 1.6 gpm/ft drawdown.
1345	Drilling reaches 614 feet bls.
1410	Driller closes in well for specific capacity test.
1455	Specific capacity is 1.61 gpm/ft.
1600	Drilling reaches 646 feet bls.
1633	Begin specific capacity test.
1650	Air line broken. Test abandoned. Test will be conducted again Monday morning.
1700	R. Dean off site. Drillers have completed work for the day and will be leaving shortly.

Recorded By: R. Dean /CH2M HILL

Date : 6/2/00

CH2M HILL DAILY SUMMARY

Day/Date: Monday/6-5-00
Project No.: 157775.A1.03
Client: City of Ft. Myers
Contractor: Well Water Systems, Inc.
Well No.: P-3
Weather: Sunny, 90 degrees F

Activity: Reverse-air drilling
Starting Depth: 646 feet bls

Bit Size: 7.875"
Ending Depth: 800 feet bls

<u>Time</u>	<u>Description</u>
0700	R. Dean arrives onsite. Driller is onsite and is preparing to continue reverse-air drilling. Static water level 13.75 feet.
0800	Driller has circulated hole and well is closed for specific capacity test.
0806	Begin test at 646 feet bls. Static WL is 13.33 feet als. Tank level is 31-inches.
0841	R. Dean notices siphon hose from holding tank is allowing discharge to leave. Test must be rerun.
0903	Specific capacity test at 646 feet bls resumes.
0925	Specific capacity test ends. Specific capacity=2.25 gpm/ft.
1020	Drilling reaches 676 feet bls.
1036	Start specific capacity test.
1101	End test. Specific capacity = 3.6 gpm/ft.
1300	Drilling reaches 707 feet bls. Preparing for specific capacity test.
1343	Test complete. Specific capacity=9.2 gpm/ft.
1455	Drilling reaches 739 feet bls. Well has been closed in. Preparing to begin test.
1523	End test. Specific capacity = 9.8 gpm/ft
1600	Drilling reaches 770 feet bls. Well closed in.
1627	Begin specific capacity test.
1650	Test complete. Specific capacity = 30 gpm/ft
1735	Drilling reaches 800 feet bls.
1800	Begin specific capacity test.
1825	Specific capacity = 32 gpm/ft.
1830	R. Dean to WTP for water quality analyses. WQ summary:
	Depth Conductivity Chlorides
	614 3800 1020
	646 4010 1002
	677 3790 974
	707 3900 967
	739 3800 930

770 3510 847
800 3460 810

1845 R. Dean leaves site for the day. Driller will leave site shortly.

Recorded By: R. Dean /CH2M HILL

Date : 6/5/00

CH2M HILL DAILY SUMMARY

Day/Date: Tuesday/6-6-00
Project No.: 157775.A1.03
Client: City of Ft. Myers
Contractor: Well Water Systems, Inc.
Well No.: P-3
Weather: Sunny, 90 degrees F

Activity: Reverse-air drilling
Starting Depth: 800 feet bls

Bit Size: 7.875"
Ending Depth: 894 feet bls

<u>Time</u>	<u>Description</u>
0715	R. Dean arrives onsite. Driller is onsite and preparing to resume reverse-air drilling. Static water level is 12.16 feet als.
0830	Drilling reaches 817 feet bls. Driller notices very hard drilling.
0900	Drilling reaches 832 feet bls. Closing in well.
1004	Specific capacity test complete. Specific capacity – 28 gpm/ft.
1240	Drilling reaches 864 feet bls. Preparing for specific capacity test.
1326	Test complete. Specific capacity = 37 gpm/ft.
1440	R. Dean leaves the site for lunch.
1510	R. Dean returns to site.
1545	Drilling reaches 894 feet bls. Preparing for final specific capacity test.
1640	Specific capacity = 36.5 gpm/ft.
1645	R. Dean leaves site for the day. Driller is cleaning site and will follow shortly.

Recorded By: R. Dean /CH2M HILL

Date : 6/6/00

CH2M HILL DAILY SUMMARY

Day/Date: Wednesday/6-7-00
Project No.: 157775.A1.03
Client: City of Ft. Myers
Contractor: Well Water Systems, Inc.
Well No.: P-3
Weather: Sunny, 90 degrees F

Activity: Preparing for logging
Starting Depth: N/A

Bit Size: 7.875"
Ending Depth: N/A

<u>Time</u>	<u>Description</u>
0700	R. Dean arrives onsite. Driller is finishing closing in well.
0800	Driller has closed in well. No further work on this site today.

Recorded By: R. Dean /CH2M HILL

Date : 6/7/00

APPENDIX D.4

Well P-4 Daily Construction Reports

CH2M HILL DAILY SUMMARY

Day/Date: Monday/5-15-00
Project No.: 157775.A1.03
Client: City of Ft. Myers
Contractor: Well Water Systems, Inc.
Well No.: P-4
Weather: Sunny, 90 degrees F

Activity: Drilling Pilot Hole, Logging, Reaming
Starting Depth: 0 feet bls

Bit Size: 7.785-inches, 29-inches
Ending Depth: 100 feet bls

<u>Time</u>	<u>Description</u>
0655	Randy Dean (Site Engineer) of CH2M HILL arrives onsite. Well Water Systems (Driller) is already onsite and is preparing to begin pilot hole drilling.
0700	Driller is waiting for delivery of power generator. Drilling has not begun.
0915	Pilot hole drilling begins. Nate is the Driller. Bruce Balmer is the Project Drilling Supervisor.
0930	Drilling reaches 8 ft.
1100	Drilling reaches 60 ft.
1200	Drilling reaches 100 ft.
1215	Southern Resources Exploration (Logger) arrives onsite.
1230	Logging begins on P-4. Logs to be conducted are LSN, SP Electric, Gamma, and Caliper.
1320	Logging complete on P-4.
1400	Begin reaming P-3 to 30-inch diameter for surface casing.
1600	R Dean notifies B. Balmer that surface casing in wells P-3 and P-4 will be set at a depth of 90 feet bls. R. Dean leaves site for the day.

Recorded By: R. Dean/CH2M HILL

Date : 5/15/00

CH2M HILL DAILY SUMMARY

Day/Date: Tuesday/5-16-00
Project No.: 157775.A1.03
Client: City of Ft. Myers
Contractor: Well Water Systems, Inc.
Well No.: P-4
Weather: Sunny, 90 degrees F

Activity: Reaming Pilot Hole, Installing Surface Casing **Bit Size:** 29-inches
Starting Depth: 10 feet bls **Ending Depth:** 94 feet bls

<u>Time</u>	<u>Description</u>
0700	Randy Dean arrives onsite. Driller is already onsite and is pilot hole reaming is beginning.
0810	Reamed hole to 67 feet bls.
0945	Reaming reaches 94 feet bls.
0950	Begin tripping out of hole for geophysical logging.
1015	Caliper log run on P-4.
1035	Rig down for repairs.
1120	R. Dean leaves site to speak with Byron Weightman at WTP.
1135	R. Dean returns to site.
1200	Rig still down. Problem is with hydraulic lift on drill mast.
1230	Rig is repaired. Beginning to install surface casing.
1325	Welding last joint of surface casing together.
1445	Starting to inject first batch of cement. Casing will be pressure grouted from 94 feet bls to land surface with neat cement. Each batch is 40 bags of cement.
1500	Second batch of cement is injected.
1515	Third batch of cement is pressure grouted.
1530	Fourth batch of cement is pressure grouted.
1550	Fifth batch of cement is pressure grouted.
1605	Sixth batch of cement is pressure grouted. Total of 240 bags of neat cement is cemented into casing. No returns noted at surface. Well will be left alone overnight and cemented tomorrow.

Recorded By: R. Dean/CH2M HILL

Date : 5/16/00

CH2M HILL DAILY SUMMARY

Day/Date: Wednesday/5-17-00
Project No.: 157775.A1.03
Client: City of Ft. Myers
Contractor: Well Water Systems, Inc.
Well No.: P-4
Weather: Sunny, 90 degrees F

Activity: Tag Cement Depth, Cement Surface Casing
Starting Depth: 11 feet bls

Bit Size: NA
Ending Depth: 0 feet bls

<u>Time</u>	<u>Description</u>
0800	Casing annulus is tagged at 11 feet bls on south, west, and east sides. Tagged at 13 feet bls on north side.
0850	Tag on inside of casing is at 90 feet bls. Thoretical value for cement needed is 10 bags of 6% bentonite grout to bring cement to land surface.
0950	Finish cementing with 10 bags 6% bentonite. Strong returns noted at surface. Driller to remain onsite today and prepare for pilot hole drilling.
1000	R. Dean leaves site for the day.

Recorded By: R. Dean/CH2M HILL

Date : 5/17/00

CH2M HILL DAILY SUMMARY

Day/Date: Thursday/5-18-00
Project No.: 157775.A1.03
Client: City of Ft. Myers
Contractor: Well Water Systems, Inc.
Well No.: P-4
Weather: Sunny, 90 degrees F

Activity: Pilot Hole Drilling
Starting Depth: 90 feet bls

Bit Size: 7.785
Ending Depth: 470 feet bls

<u>Time</u>	<u>Description</u>
0655	Randy Dean arrives onsite. Driller is arriving onsite.
0735	Mud pump has broken down. Drilling stops.
0805	Pump is running. Drilling continues.
0915	Pilot hole to 124 feet bls.
1025	Pilot hole to 165 feet bls.
1155	Pilot hole to 220 feet bls.
1315	Pilot hole to 310 feet bls.
1436	Pilot hole to 325 feet bls. Drilling through clay. Very slow.
1631	Pilot hole to 376 feet bls.
1744	Pilot hole to 420 feet bls.
1810	Pilot hole to 451 feet bls.
1955	Pilot hole drilling stops for day at 470 feet bls.
2000	R. Dean leaves site for the day. Driller will leave site shortly.

Recorded By: R. Dean/CH2M HILL

Date : 5/18/00

CH2M HILL DAILY SUMMARY

Day/Date: Friday/5-19-00
Project No.: 157775.A1.03
Client: City of Ft. Myers
Contractor: Well Water Systems, Inc.
Well No.: P-4
Weather: Sunny, 90 degrees F

Activity: Pilot Hole Drilling. Logging
Starting Depth: 470 feet bls

Bit Size: 7.785
Ending Depth: 562 feet bls

<u>Time</u>	<u>Description</u>
0755	Randy Dean arrives onsite. Driller is already onsite and tripping drill rods into hole. Driller will recirculate drilling mud and resume pilot hole drilling shortly.
0900	Pilot hole to 462 feet bls.
0945	Pilot hole to 465 feet bls.
1000	John Vincent and Steve Miller of MV Geophysical (Loggers) arrive onsite.
1010	R. Dean notifies driller to continue drilling to 500 feet bls.
1030	Pilot hole to 490 feet bls. Intermixed limestone and clay returns noted.
1055	R. Dean instructs Driller to continue pilot hole to 530 feet bls.
1126	Pilot hole to 532.03 feet bls. B. Beddow instructs Driller to complete current rod in hole to bring total depth to 562 feet bls.
1230	Pilot hole to 550 feet bls. Driller will continue to 560 feet bls.
1615	Geophysical logging begins. Logs to be run are LSN, SP Electric, Gamma, and XY Caliper.
1630	Logger tags bottom of hole at 562 feet bls.
1800	Logger is done on this site. Driller to begin reaming Monday 5/22/00.

Recorded By: R. Dean/CH2M HILL

Date : 5/19/00

CH2M HILL DAILY SUMMARY

Day/Date: Monday/5-22-00
Project No.: 157775.A1.03
Client: City of Ft. Myers
Contractor: Well Water Systems, Inc.
Well No.: P-4
Weather: Sunny, 90 degrees F

Activity: Reaming
Starting Depth: 94 feet bls

Bit Size: 22.5-inches
Ending Depth: 175 feet bls

<u>Time</u>	<u>Description</u>
0655	R. Dean arrives onsite. Driller is onsite and preparing to begin reaming pilot hole with a 22.5-inch bit.
1100	Rig is down temporarily.
1135	Reaming resumes. Reamed hole to 112 feet bls.
1700	Driller has finished reaming for the day. Reaming depth of 175 feet bls reached.

Recorded By: R. Dean/CH2M HILL

Date : 5/22/00

CH2M HILL DAILY SUMMARY

Day/Date: Tuesday/5-23-00
Project No.: 157775.A1.03
Client: City of Ft. Myers
Contractor: Well Water Systems, Inc.
Well No.: P-4
Weather: Sunny, 90 degrees F

Activity: Reaming
Starting Depth: 175 feet bls

Bit Size: 22.5-inches
Ending Depth: feet bls

<u>Time</u>	<u>Description</u>
0730	R. Dean arrives onsite. Driller is tripping into hole to continue reaming.
0930	Depth is approximately 270 feet bls. Reaming stops to wait for mud tanks to be emptied.
1045	Brief rainfall at site.
1130	Reaming reaches 330 feet bls.

Recorded By: R. Dean/CH2M HILL

Date : 5/23/00

CH2M HILL DAILY SUMMARY

Day/Date: Wednesday/5-24-00
Project No.: 157775.A1.03
Client: City of Ft. Myers
Contractor: Well Water Systems, Inc.
Well No.: P-4
Weather: Sunny, 90 degrees F

Activity: Reaming

Bit Size: 22.5-inches

Starting Depth: 420 feet bls

Ending Depth: 515 feet bls

<u>Time</u>	<u>Description</u>
0715	R. Dean arrives onsite. Mud tank is being emptied and no work has been started on this site today. Final reaming depth yesterday was 420 feet bls.
0900	Reaming depth to 424 feet bls.
1330	Reaming depth to 478 feet bls.
1500	Reaming depth to 500 feet bls. Driller will ream to 515 feet bls.
1530	R. Dean leaves site for the day.

Recorded By: R. Dean/CH2M HILL

Date : 5/24/00

CH2M HILL DAILY SUMMARY

Day/Date: Thursday/5-25-00
Project No.: 157775.A1.03
Client: City of Ft. Myers
Contractor: Well Water Systems, Inc.
Well No.: P-4
Weather: Sunny, 90 degrees F

Activity: None
Starting Depth: N/A

Bit Size: N/A
Ending Depth: N/A

<u>Time</u>	<u>Description</u>
-------------	--------------------

0700	No work completed on this site today.
------	---------------------------------------

Recorded By: R. Dean/CH2M HILL

Date : 5/25/00

CH2M HILL DAILY SUMMARY

Day/Date: Friday/5-26-00
Project No.: 157775.A1.03
Client: City of Ft. Myers
Contractor: Well Water Systems, Inc.
Well No.: P-4
Weather: Sunny, 90 degrees F

Activity: Reaming and Cementing
Starting Depth: 515 feet bls

Bit Size: 22-inches
Ending Depth: 518 feet bls

<u>Time</u>	<u>Description</u>
0700	R. Dean onsite. Driller will ream hole additional 3 feet to prepare for installation of cement plug.
1300	Reaming to 518 feet bls. Driller will pump 8 bags of neat cement to plug reamed hole and hole from stinger bit.
1400	A. Fanguaire on-site, R. Dean on-site.
1545	R. Dean off-site
1600	Begin mixing 8 bags of cement for plug. Cement plan: 8 bags neat, 41.78 gallons of water, 190 gallon chase.
1610	Begin pumping cement.
1625	Finish pumping, driller beginning cleanup, AF off-site for day.

Recorded By: R. Dean, A. Fanguaire/CH2M HILL

Date : 5/26/00

CH2M HILL DAILY SUMMARY

Day/Date: Tuesday/5-30-00
Project No.: 157775.A1.03
Client: City of Ft. Myers
Contractor: Well Water Systems, Inc.
Well No.: P-4
Weather: Sunny, 90 degrees F

Activity: Reaming
Starting Depth: 515 feet bls

Bit Size: 22"
Ending Depth: 515 feet bls

<u>Time</u>	<u>Description</u>
0655	A. Fanguiare on-site, driller on-site, tripping in hole to begin reaming.
0700	Begin reaming.
0830	Continue reaming. Depth – 290 feet bls
0950	Bottom tagged by drill, 517 feet bls
1130	AF off-site for lunch
1200	AF on-site, driller continuing to develop hole.
1345	Driller tripped out of hole.
1530	Informed B. Beddow of tag depth. He is concerned by smallness of plug, requests 4.5 additional bags of cement be poured.
1600	Spoke with B. Balmer. Driller on rig did not calculate additional 2' at end of drill bit, actual tag depth is 515. B. Beddow is satisfied with this depth, no new cement is necessary.
1700	AF off-site for day.

Recorded By: A. Fanguiare/CH2M HILL

Date : 5/30/00

CH2M HILL DAILY SUMMARY

Day/Date: Wednesday/5-31-00
Project No.: 157775.A1.03
Client: City of Ft. Myers
Contractor: Well Water Systems, Inc.
Well No.: P-4
Weather: Sunny, 90 degrees F

Activity: Logging/Reaming
Starting Depth: 515 feet bls

Bit Size: 22"
Ending Depth: 515 feet bls

<u>Time</u>	<u>Description</u>
0630	A. Fanguiare on-site, driller on-site, tripping in hole to begin reaming.
0700	Begin wiper pass.
0830	Wiper pass complete, waiting for logger.
0915	MV Geophysical logger on-site.
0930	Lowering caliper log into well.
0940	Bottom tagged by caliper log – 515' 4". Spoke with B. Balmer about casing. Casing to be set to depth of 510' bls. He will use 25 20' long PVC pieces and one 11'2" piece, which includes extra 1'2" for elevator and I-beams.q
0950	B. Beddow on-site. First pass with caliper log complete. Begin lowering for second pass.
1015	Second pass complete. Logs indicate several areas with diameter less than 22". Driller will continue to ream hole, and logger will return tomorrow 8:30 AM
1045	MV off-site Driller tripping in hole to begin reaming.
1730	Driller has reamed hole throughout day. AF off-site for day.

Recorded By: A. Fanguiare/CH2M HILL

Date : 5/31/00

CH2M HILL DAILY SUMMARY

Day/Date: Thursday/6-1-00
Project No.: 157775.A1.03
Client: City of Ft. Myers
Contractor: Well Water Systems, Inc.
Well No.: P-4
Weather: Sunny, 90 degrees F

Activity: Installing casing/grouting
Starting Depth: 0 feet bls

Bit Size: N/A
Ending Depth: 510 feet bls

<u>Time</u>	<u>Description</u>
0700	Driller is completing wiper pass on reamed hole.
0830	MV Geophysical arrives onsite.
0945	MV Geophysical offsite. Caliper log run on reamed hole.
1000	Final 16-inch casing installation begins.
1205	Bobby Kohlmeier speaks with Bill Beddow to discuss cement plan. Agree to pressure grout 120 bags 4% bentonite followed by 80 bags neat.
1426	Casing installed to 510 feet bls. Driller is installing tremmie pipe.
1545	Tremmie installed. Driller is circulating mud in hole.
1724	Begin mixing batch 1 of 4 of 4% bentonite.
1736	Begin mixing batch 2 of 4.
1745	Begin mixing batch 3 of 4. 8 psi.
1803	Begin mixing batch 4 of 4. 10.5 psi. Total 120 bags neat cement pumped.
1807	Begin mixing batch 1 of 2 of neat cement. 14 psi.
1817	Begin mixing batch 2 of 2 of neat cement. 21 psi. Total 80 bags neat cement pumped.
1829	Begin chase with 316 gallons of water.
1845	R. Dean leaves site for the day. Driller is cleaning equipment and will follow shortly.

Recorded By: R. Dean/CH2M HILL

Date : 6/1/00

CH2M HILL DAILY SUMMARY

Day/Date: Friday/6-2-00
Project No.: 157775.A1.03
Client: City of Ft. Myers
Contractor: Well Water Systems, Inc.
Well No.: P-4
Weather: Sunny, 90 degrees F

Activity: Grouting PVC Casing
Starting Depth: 202 feet bls

Bit Size: N/A
Ending Depth: 32 feet bls

<u>Time</u>	<u>Description</u>
0700	R. Dean arrives onsite. Driller is installing tremmie pipe for cement tag.
0900	Driller cannot advance tremmie pipe past 202 feet bls on front side.
1000	Driller cannot advance tremmie pipe past 199 feet bls on back side.
1050	B. Beddow approves to cement casing from 202 feet bls.
1150	Begin mixing first batch (30 bags) of 4% bentonite cement. Tremmie pipe set at 195 feet bls.
1200	First batch pumped. 14 lbs.
1217	Second batch pumped. 14 lbs.
1230	Third batch pumped. 13 lbs.
1251	Fourth batch pumped. 13.5 lbs. One tremmie pipe (21 feet) removed from well.
1309	Fifth batch pumped
1312	Remove 42 feet of tremmie pipe.
1340	Sixth batch pumped. 13.7 lbs.
1700	Tag inside of casing at 38 feet bls. Grouting will be completed 6/5/00.
1715	R. Dean leaves site for the day. Driller to follow shortly. ·

Recorded By: R. Dean/CH2M HILL

Date : 6/2/00

CH2M HILL DAILY SUMMARY

Day/Date: Monday/6-5-00
Project No.: 157775.A1.03
Client: City of Ft. Myers
Contractor: Well Water Systems, Inc.
Well No.: P-4
Weather: Sunny, 90 degrees F

Activity: Grouting PVC Casing/Alignment Test
Starting Depth: 32 feet bls

Bit Size: N/A
Ending Depth: 0 feet bls

<u>Time</u>	<u>Description</u>
0700	R. Dean arrives onsite. Driller is installing tremmie pipe for cement tag.
0810	Cement tagged at 32 feet bls. Driller is mixing 30 bags of 4% bentonite.
0830	Small cement returns noted at surface. Driller is mixing 12 additional bags of neat cement to completely bring cement to surface.
0839	Strong cement returns at surface.
1100	B. Beddow informs R. Dean that Driller may use 12-inch diameter dummy pipe for alignment test.
1105	Driller begins installing 30-foot section of dummy pipe into well.
1200	Driller installs dummy pipe to depth of 300 feet bls with no obstructions. No further work completed at this site today.

Recorded By: R. Dean/CH2M HILL

Date : 6/5/00

CH2M HILL DAILY SUMMARY

Day/Date: Tuesday/6-6-00
Project No.: 157775.A1.03
Client: City of Ft. Myers
Contractor: Well Water Systems, Inc.
Well No.: P-4
Weather: Sunny, 90 degrees F

Activity: Reverse-Air Drilling
Starting Depth: 510 feet bls

Bit Size: 7.785-inches
Ending Depth: 563 feet bls

<u>Time</u>	<u>Description</u>
0700	R. Dean arrives onsite. Driller is preparing for reverse air drilling.
1210	Drilling reaches 532 feet bls. Driller states that no water is being produced in well. R. Dean instructs Driller to proceed to 563 feet bls.
1530	Drilling reaches 563 feet bls. Driller is closing in well for specific capacity test.
1628	Specific capacity = 1.4 gpm/ft.

Recorded By: R. Dean/CH2M HILL

Date : 6/6/00

CH2M HILL DAILY SUMMARY

Day/Date: Wednesday/6-7-00
Project No.: 157775.A1.03
Client: City of Ft. Myers
Contractor: Well Water Systems, Inc.
Well No.: P-4
Weather: Sunny, 90 degrees F

Activity: Reverse-Air Drilling
Starting Depth: 563 feet bls

Bit Size: 7.785-inches
Ending Depth: 688 feet bls

<u>Time</u>	<u>Description</u>
0700	R. Dean arrives onsite. Driller is preparing to collect water sample from 563 feet bls.
0900	Drilling reaches 594 feet bls. Driller is closing in well for specific capacity test.
1009	Specific capacity = 1.8 gpm/ft.
1145	Drilling reaches 625 feet bls. Driller is closing in well for specific capacity test.
1213	Specific capacity = 3.4 gpm/ft.
1320	Drilling reaches 657 feet bls. Driller is closing in well for specific capacity test.
1325	Driller is replacing bushing on well.
1420	Driller closes well in for test.
1501	Specific capacity = 5.7 gpm/ft.
1650	Begin specific capacity test at 688 feet bls.
1716	Specific capacity = 8.1 gpm/ft.
1730	R. Dean leaves site for the day. Driller will follow shortly.

Water Quality Summary

Depth	Cl	Conductivity (mS/cm)
563	620	2660
594	660	2900
625	720	3080
657	780	3300
688	800	3440

Recorded By: R. Dean/CH2M HILL

Date : 6/7/00

CH2M HILL DAILY SUMMARY

Day/Date: Thursday/6-8-00
Project No.: 157775.A1.03
Client: City of Ft. Myers
Contractor: Well Water Systems, Inc.
Well No.: P-4
Weather: Sunny, 90 degrees F

Activity: Reverse-Air Drilling
Starting Depth: 688 feet bls

Bit Size: 7.785-inches
Ending Depth: 814 feet bls

<u>Time</u>	<u>Description</u>
0700	R. Dean arrives onsite. Driller is preparing to resume drilling. Static water level is 15.5 feet als.
0835	Drilling reaches 720 feet bls. Driller is closing in well for specific capacity test.
0916	Specific capacity = 12.7 gpm/ft.
1116	Drilling reaches 751 feet bls. Driller is closing in well for specific capacity test.
1138	Specific capacity = 15.9 gpm/ft.
1348	Drilling reaches 782 feet bls. Driller is closing in well for specific capacity test.
1407	Specific capacity = 24.2 gpm/ft.
1530	Drilling reaches 814 feet bls. Driller is closing in well for specific capacity test.
1619	Specific capacity = 31 gpm/ft.
1640	R. Dean leaves site for the day. Driller will follow shortly.

Water Quality Summary

Depth	Cl	Conductivity (mS/cm)
720	620	2660
751	660	2900
782	740	3130

Recorded By: R. Dean/CH2M HILL

Date : 6/8/00

APPENDIX D.5

Well P-5 Daily Construction Reports

CH2M HILL DAILY SUMMARY

Day/Date: Monday/7-03-00
Project No.: 157775.A1.03
Client: City of Ft. Myers
Contractor: Well Water Systems, Inc.
Well No.: P-5
Weather: Sunny, 90 degrees F

Activity: Pilot Hole Drilling/Geophysical Logging **Bit Size:** 7.785-inches
Starting Depth: 0 feet bls **Ending Depth:** 110 feet bls

<u>Time</u>	<u>Description</u>
0700	R. Dean arrives onsite. Driller is already onsite and is preparing to drill pilot hole.
0745	B. Balmer calls to discuss surface casing setting depth. R. Dean informs him that we will drill to approximately 105 feet bls and decide on casing depth after logging.
0830	B. Beddow calls to discuss surface casing. Notifies R. Dean that he and Bobby Kohlmeier agreed to set 26-inch casing in the remaining wells.
0845	R. Dean speaks to B. Balmer about surface casing. B. Balmer states that he has no plans on using 26-inch casing on P-5.
0905	B. Beddow calls R. Dean. R. Dean informs him that the Driller has no plans to install 26-inch casing. B. Beddow will call B. Kohlmeier.
0925	B. Beddow calls R. Dean. B. Beddow agreed with B. Kohlmeier to use 24-inch casing on well P-5 only. Wells P-7 and P-6 will include 26-inch surface casing. The following items were also decided: <ol style="list-style-type: none">1. Final reamed hole will be a minimum of 23-inches in diameter throughout the entire well or final casing will not be run.2. Reaming stabilizer bit will be 22-inches in diameter.3. Reaming bit will be no less than 22.5-inches in diameter.4. If well P-5 has the same cementing problem as P-3 and P-4, CH2M HILL will not accept the well.
1110	Drilling reaches 105 feet bls. Driller started drilling into rock at 102 feet bls. R. Dean instructs Driller to continue pilot hole to 110 feet bls.
1145	MV Geophysical arrives onsite.
1330	Geophysical logging is complete.
1400	MV Geophysical leaves site. R. Dean leaves site for the day. Driller is preparing for pilot hole reaming

Recorded By: R. Dean/CH2M HILL

Date : 7/03/00

CH2M HILL DAILY SUMMARY

Day/Date: Tuesday/7-04-00
Project No.: 157775.A1.03
Client: City of Ft. Myers
Contractor: Well Water Systems, Inc.
Well No.: P-5
Weather: Sunny, 90 degrees F

Activity: None
Starting Depth: N/A

Bit Size: 7.785-inches
Ending Depth: N/A

Time **Description**

There were no construction activities on site today. Joey Summerall was onsite to grade road between wells P-5 and P-7.

Recorded By: R. Dean/CH2M HILL

Date : 7/04/00

CH2M HILL DAILY SUMMARY

Day/Date: Wednesday/7-05-00
Project No.: 157775.A1.03
Client: City of Ft. Myers
Contractor: Well Water Systems, Inc.
Well No.: P-5
Weather: Sunny, 90 degrees F

Activity: Reaming **Bit Size:** 32-inches
Starting Depth: 0 feet bls **Ending Depth:** 97 feet bls

<u>Time</u>	<u>Description</u>
0710	R. Dean arrives onsite. Driller is onsite and is beginning to ream pilot hole to casing setting depth of 92 feet bls. Driller will ream hole to total depth of 97 feet bls.
1100	Reaming has reached 15 feet bls. R. Dean leaves the site.
1230	R. Dean returns to site.
1520	B. Balmer tells R. Dean that he will provide list of standby time for wells P-3 and P-4 tomorrow.
1540	Reaming reaches depth of 97 feet bls.
1600	R. Dean leaves site for the day.
1610	Drillers leave site for the day. Geophysical logging is scheduled for 0800 tomorrow.

Recorded By: R. Dean/CH2M HILL

Date : 7/05/00

CH2M HILL DAILY SUMMARY

Day/Date: Thursday/7-06-00
Project No.: 157775.A1.03
Client: City of Ft. Myers
Contractor: Well Water Systems, Inc.
Well No.: P-5
Weather: Sunny, 90 degrees F

Activity: Geophysical Logging/Surface Casing **Bit Size:** 32-inches
Starting Depth: 0 feet bls **Ending Depth:** 97 feet bls

<u>Time</u>	<u>Description</u>
0730	R. Dean arrives onsite. Driller is onsite and is completing wiper pass on hole. MV Geophysical is onsite.
0800	B. Balmer notifies R. Dean of cement plan for surface casing. Driller wants to pump only theoretical cement volume today, and will bring cement to surface tomorrow if necessary.
0845	B. Weightman arrives onsite. B. Weightman notifies R. Dean that all construction activities to date are completely satisfactory. No additional work needs to be done on the canal berm except for final grading and reseeding.
1000	Geophysical logging complete. MV Geophysical leaves site.
1100	R. Dean speaks with B. Beddow. Cement plan is to pump 210 bags of 4% bentonite grout today, and then theoretical 4% volume tomorrow to bring cement to approximately 20 feet bls. Cement will set for approximately 4 hours and then neat cement will be used to bring grout to surface.
1200	R. Dean leaves site to check with Eastwood GC personnel. Driller is setting up for cementing.
1220	R. Dean returns to site. Driller is mixing 1 st batch of cement.
1229	30 bags 4% bentonite pressure grouted. 13.0 lbs.
1245	30 bags 4% bentonite pressure grouted. 13.0 lbs.
1300	30 bags 4% bentonite pressure grouted. 13.8 lbs.
1314	30 bags 4% bentonite pressure grouted. 14.0 lbs.
1325	30 bags 4% bentonite pressure grouted. 13.9 lbs.
1338	30 bags 4% bentonite pressure grouted. 14.0 lbs.
1350	30 bags 4% bentonite pressure grouted. 13.7 lbs.
1400	Total 210 bags 4% bentonite pressure grouted into well.
1430	R. Dean leaves site for the day.

Recorded By: R. Dean/CH2M HILL

Date : 7/06/00

CH2M HILL DAILY SUMMARY

Day/Date: Friday/7-07-00
Project No.: 157775.A1.03
Client: City of Ft. Myers
Contractor: Well Water Systems, Inc.
Well No.: P-5
Weather: Sunny, 90 degrees F

Activity: Cement Surface Casing
Starting Depth: 40 feet bls

Bit Size: 32-inches
Ending Depth: 0 feet bls

<u>Time</u>	<u>Description</u>
0700	R. Dean arrives onsite. Driller is onsite and preparing to tag cement depth.
0710	Driller tags cement on two sides of casing at 40 feet bls. Driller tags inside of casing at 88 feet bls.
0855	First batch of 4% bentonite pumped (30 bags).
0907	Second batch of 4% bentonite pumped (30 bags).
0928	Third batch of 4% bentonite pumped (30 bags).
0943	Fourth batch of 4% bentonite pumped (30 bags). Total 120 bags 4% bentonite pumped.
1230	R. Dean leaves site for lunch.
1305	R. Dean returns to site.
1410	Tag cement in annular zone at 8 feet on one side and 10 feet on other side.
1440	Mix 20 bags neat cement.
1445	Mix 20 bags neat cement.
1455	Cement returns noted at surface. Driller will top off cement to surface on Monday.
1530	R. Dean leaves site. Driller is finished with activities today and will leave the site shortly.
1730	R. Dean returns to site.
1800	R. Dean leaves site for the day.

Recorded By: R. Dean/CH2M HILL

Date : 7/07/00

CH2M HILL DAILY SUMMARY

Day/Date: Monday/7-10-00
Project No.: 157775.A1.03
Client: City of Ft. Myers
Contractor: Well Water Systems, Inc.
Well No.: P-5
Weather: Sunny, 90 degrees F

Activity: Pilot Hole Drilling
Starting Depth: 110 feet bls

Bit Size: 7.785-inches
Ending Depth: 320 feet bls

<u>Time</u>	<u>Description</u>
0700	R. Dean arrives onsite. Driller is onsite and preparing install flange on surface casing. Driller will then proceed with pilot hole drilling to +/- 550 feet bls.
1000	Drilling has reached 190 feet bls.
1300	Drilling has reached 270 feet bls.
1500	Generator is down for repairs. Drilling has stopped.
1530	Driller notifies R. Dean that drilling is done for the day. The generator will either be fixed today or replaced in the morning to start drilling at 0700.
1750	R. Dean leaves the site for the day.

Recorded By: R. Dean/CH2M HILL

Date : 7/10/00

CH2M HILL DAILY SUMMARY

Day/Date: Thursday/7-13-00
Project No.: 157775.A1.03
Client: City of Ft. Myers
Contractor: Well Water Systems, Inc.
Well No.: P-5
Weather: Partly Sunny, 90 degrees F

Activity: Ream Hole Drilling
Starting Depth: 160 feet bls
Bit Size: 23.25-inches
Ending Depth: 316 feet bls

<u>Time</u>	<u>Description</u>
0730	R. Dean and Dan Jablonski onsite. TD = 160 feet bls with 23.25-inch ream hole.
0800	R. Dean and D. Jablonski met with Byron at WTP facility. Informed Byron that D. Jablonski will be onsite from 7/13/00 to 7/21/00 in place of R. Dean.
1330	D. Jablonski onsite to trailer. WWS making repairs to P-7 drill rig.
1400	TD at P-5 = 290 feet bls.
1630	TD = 310 feet bls. Tally of 47 strings of 20 ' , 16" PVC casing onsite.
1645	WWS tripping out drill rods. Finished drilling for the day. End TD at P-5 = 316 feet bls.
1700	D. Jablonski offsite for the day.

Recorded By: Dan Jablonski/CH2M HILL

Date : 7/13/00

CH2M HILL DAILY SUMMARY

Day/Date: Friday/7-14-00
Project No.: 157775.A1.03
Client: City of Ft. Myers
Contractor: Well Water Systems, Inc.
Well No.: P-5
Weather: Partly Sunny, 90 degrees F

Activity: Ream Hole Drilling
Starting Depth: 316 feet bls
Bit Size: 23.25-inches
Ending Depth: 430 feet bls

<u>Time</u>	<u>Description</u>
0730	Dan J. onsite to trailer. Spoke with Bill Beddow via cell-phone. Bill will call back after speaking to Randy Dean. Start TD at P-5 with ream bit = 316 feet bls.
0830	Dan J. onsite to P-5. TD = 319 feet bls. Still drilling through clay confinement.
0900	Spoke with Bill B. and Randy D. regarding final casing setting depth for P-5. Agreed upon casing setting depth of 480 feet bls pending approval from Mark McNeal. Bill also requested WWS to weld tabs onto P-7 24-inch diameter reaming bit for final casing. This will increase the bit size to a nominal 24.25 inches.
1030	TD at P-5 = 325 feet bls. Drilling very slow through clay confinement. Instructed Bruce Balmer to clean up loose equipment near P-3 and P-4 and excavate oil contaminated soil near wellheads.
1200	Dan J. offsite for lunch.
1300	Dan J. onsite to trailer. Verified Mike's drill rod tally for P-5. Tally is correct.
1400	Dan J. to P-7 site. 5 strings of 26-inch steel surface casing onsite. Casing is approximately 40 feet in length and 0.375 inches in diameter. Heat numbers are labeled onto stickers for 3 strings. Two strings have heat numbers painted on the inside of casing. Heat numbers = G05643.
1445	TD at P-5 = 380 feet bls. Tripping out. Adding a drill rod.
1545	Bruce B. submitted mill certificate for P-7 surface casing. Heat number OK. Bruce informed Dan J. that standby time for P-7 ended at 1530.
1600	Dan J. offsite to Tampa. End TD at P-5 = 430 feet bls.

Recorded By: Dan Jablonski/CH2M HILL

Date : 7/14/00

CH2M HILL DAILY SUMMARY

Day/Date: Monday/7-17-00
Project No.: 157775.A1.03
Client: City of Ft. Myers
Contractor: Well Water Systems, Inc.
Well No.: P-5
Weather: Partly Sunny, 90 degrees F

Activity: Ream Hole Drilling
Starting Depth: 430 feet bls
Bit Size: 23.25-inches
Ending Depth: 486 feet bls

<u>Time</u>	<u>Description</u>
0830	Dan J. onsite to trailer. Spoke with Bill Beddow via cell-phone regarding update on drilling activities.
0900	Dan J. onsite to P-5. WWS making a wiper pass to 430 feet bls while tripping in drill rods. Bruce Balmer making repairs to P-7 drill rig. Bearings onsite. Reaming should commence within 2 to 3 hours. Spoke with Randy Dean via cell-phone. Randy requested Dan J. to obtain a purchase order for P-7 surface casing to confirm beginning of Standby Time.
1030	Onsite to P-7. Still making repairs to drill rig.
1200	Dan J. offsite for lunch.
1300	Dan J. onsite. Submitted cement plan for P-5 to Bill Beddow. Will pump 84 sacks of neat cement and 120 sacks of 4% bentonite cement.
1400	TD at P-5 = 485 feet bls plus 1 foot of lead bit. Limestone returns. Circulating borehole. Will trip out and make a wiper pass to total depth.
1415	Still making repairs to P-7 drill rig.
1630	Tripping out rods at P-5. Wiper pass complete. No major obstructions were noted during the wiper pass.
1645	Dan J. offsite for the day.

Recorded By: Dan Jablonski/CH2M HILL

Date : 7/17/00

CH2M HILL DAILY SUMMARY

Day/Date: Tuesday/7-18-00
Project No.: 157775.A1.03
Client: City of Ft. Myers
Contractor: Well Water Systems, Inc.
Well No.: P-5
Weather: Partly Sunny, 90 degrees F

Activity: Set final casing
Starting Depth: 486 feet bls
Bit Size: 23.25-inches
Ending Depth: 486 feet bls

<u>Time</u>	<u>Description</u>
0715	Dan J. onsite. WWS making wiper pass to TD. Measured 24 strings of 16-inch diameter casing. Each string 20 feet in length. First string will have an extra 2.75 feet of casing splined to bottom. First string = 22.75 feet in length.
0900	TD = 486 feet bls with wiper pass. Circulating borehole.
0945	Tripping out drill rods. MV Geophysical Surveys, Inc. onsite.
1045	Tripped out drill rods plus reaming barrel and bit. Preparing to conduct caliper log.
1100	TD at bottom of hole = 490 feet bls (original pilot hole from 486 feet bls to 490 feet bls).
1200	Logs complete. Faxing logs to Bill Beddow.
1215	Begin setting 16-inch diameter PVC final casing (SDR 17) Casing thickness = 0.07 feet Casing OD = 1.31 feet, Casing ID = 1.18 feet Bell OD = 1.45 feet, Bell ID = 1.34 feet
1255	Splining 8 th string of casing.
1330	Splining 17 th string of casing. No obstruction noted.
1415	Casing set at 480 feet bls. Top of 24 th string of casing is approx. 2.75 feet above land surface. Attached header to casing in preparation for pressure grouting.
1500	Installing 11 sticks of 1 ¼ -inch diameter steel tremie in annular space. Each stick is 21 feet in length. Tremie set at 231 feet bls minus 6 feet = 225 feet bls.
1530	Installing 2-inch diameter steel tremie down casing. Updated Bill Beddow on activities. Bill gave permission to install tremie down annular space prior to pressure grouting.
1600	2-inch diameter tremie set at 456 feet bls.
1630	Pumped water down tremie. Checked for circulation. Circulation was OK.
1645	Began pumping first batch (30 sacks) of 4% bentonite cement. Mud returns were observed at land surface. 4% weight = 13.9 lbs per gallon. Note: Mud scale is 0.2 lbs off (scale reads 0.2 lbs lighter than actual values). Verified calibration with water weight.
1650	Began pumping second batch (30 sacks) of 4% bentonite cement. Mud returns were

- observed at land surface. 4 % weight = 13.6 lbs per gallon.
- 1708 Began pumping third batch (30 sacks) of 4% bentonite cement. Mud returns were observed at land surface. 4% weight = 14.1 lbs per gallon.
- 1720 Began pumping fourth batch (30 sacks) of 4% bentonite cement. Mud returns were observed at land surface. 4% weight = 14.2 lbs per gallon.
- 1735 Began pumping first batch (42 sacks) of neat cement. Mud returns were observed at land surface. Neat weight = 15.0 lbs per gallon.
- 1745 Began pumping second batch (42 sacks) of neat cement. Mud returns were observed at land surface. Neat weight = 15.7 lbs per gallon.
- 1752 Chased neat cement with 242 gallons of water. Mud returns were observed at land surface. The well was shut-in at 37 psi.
- 1800 Dan J. offsite for the day. The total number of sacks pumped today was 120 sacks of 4% bentonite cement and 84 sacks of neat cement.
WWS will pull 3 to 4 sticks of tremie at 10 PM tonight.
-

Recorded By: Dan Jablonski/CH2M HILL

Date : 7/18/00

CH2M HILL DAILY SUMMARY

Day/Date: Wednesday/7-19-00
Project No.: 157775.A1.03
Client: City of Ft. Myers
Contractor: Well Water Systems, Inc.
Well No.: P-5
Weather: Partly Cloudy, 93 degrees F

Activity: Stage 2 cementing of final casing
Starting Depth: 486 feet bls

Bit Size: 23.25-inches
Ending Depth: 486 feet bls

<u>Time</u>	<u>Description</u>
0700	Dan J. onsite. WWS onsite. Tagged cement inside casing at 462 feet bls. Tripping out 2-inch diameter tremie from inside casing.
0750	Tagged annular cement at 356 feet bls. 17 sticks (21 feet each) plus one 8-foot piece minus 5 feet floor minus 4 feet of tremie.
0800	Lowering 1 ¼-inch diameter tremie on opposite side of casing.
0830	Tagged cement at 357 feet bls (17 sticks below land surface).
0845	Phone Bill Beddow regarding tag depth and cement plan for the day. Bruce proposed to pump 180 sacks of 4% bentonite cement. The theoretical lift is approx. 140 feet.
0900	1 ¼-inch diameter steel tremie set at 335 feet bls in annular space (16 sticks plus one 8 foot stick).
0930	Began pumping first batch (30 sacks) of 4% bentonite cement. Water/mud returns observed at land surface. (mud level prior to pumping was approx. 30 feet bls inside annular space). 4% weight = 13.1 lbs per gallon.
0945	Began pumping second batch (30 sacks) of 4% bentonite cement. Mud returns observed at land surface. 4% weight = 14.0 lbs per gallon.
0950	Pulled one stick of tremie out of annular space.
0955	Began pumping third batch (30 sacks) of 4% bentonite cement. Mud returns observed at land surface. 4% weight = 13.9 lbs per gallon.
1010	Began pumping fourth batch (30 sacks) of 4% bentonite cement. Mud returns observed at land surface. 4% weight = 14.0 lbs per gallon.
1015	Pulling second stick of tremie out of annular space.
1025	Began pumping fifth batch (30 sacks) of 4% bentonite cement. Mud returns observed at land surface. 4% weight = 13.9 lbs per gallon.
1045	Finished sixth batch (30 sacks) of 4% bentonite cement. Mud returns observed at land surface. 4% weight = 14.3 lbs per gallon. A total of 180 sacks of 4% bentonite cement were used for Stage 2.
1100	Dan J. offsite. WWS pulling up tremie.
1200	Dan J. onsite to trailer.
1400	Dan J. inspected area near wells P-3 and P-4. Most of the debris and equipment has

been removed from the site. Drill rods and tremie pipe are still located near P-4.
Dan J. to P-7 location for the day.

Recorded By: Dan Jablonski/CH2M HILL

Date : 7/19/00

CH2M HILL DAILY SUMMARY

Day/Date: Thursday/7-20-00
Project No.: 157775.A1.03
Client: City of Ft. Myers
Contractor: Well Water Systems, Inc.
Well No.: P-5
Weather: Partly Cloudy, 90 degrees F

Activity: Stage 3 cementing of final casing **Bit Size:** N/A
Starting Depth: N/A **Ending Depth:** N/A

<u>Time</u>	<u>Description</u>
0700	Dan J. onsite. WWS onsite. Checked cement samples from yesterday's cementing. Cement samples had set.
0715	Tagged annular cement at 163 feet bls. (8 sticks of 1 ¼-inch diameter tremie plus one 8-footer minus 5 foot floor minus 8 feet of tremie).
0800	Tagged opposite side of annulus at 167 feet bls.
0815	Phoned Bill Beddow regarding cement tag depth and cement plan.
0840	1 ¼-inch diameter steel tremie set at 146 feet bls (7 sticks plus one 8-footer).
0945	Preparing to pump 4% bentonite cement.
0955	Began pumping first batch (30 sacks) of 4% bentonite cement. Mud returns observed at land surface. 4% weight = 13.6 lbs per gallon.
1005	Began pumping second batch (30 sacks) of 4% bentonite cement. Mud returns observed at land surface. 4% weight = 13.8 lbs per gallon.
1018	Began pumping third batch (30 sacks) of 4% bentonite cement. Good mud returns observed at land surface. 4% weight = 13.9 lbs per gallon.
1030	Began pumping fourth batch (30 sacks) of 4% bentonite cement. Good mud returns observed at land surface. 4% weight = 13.8 lbs per gallon.
1045	Began pumping fifth batch (30 sacks) of 4% bentonite cement. Good mud returns observed at land surface. 4% weight = 13.8 lbs per gallon.
1100	Began pumping sixth batch (30 sacks) of 4% bentonite cement. Good mud returns observed at land surface. 4% weight = 13.8 lbs per gallon. No cement returns evident.
1105	Dan J. offsite to P-7 location. Pumped a total of 180 sacks of 4% bentonite cement pumped for Stage 3.

Recorded By: Dan Jablonski/CH2M HILL

Date : 7/20/00

CH2M HILL DAILY SUMMARY

Day/Date: Monday/7-24-00
Project No.: 157775.A1.03
Client: City of Ft. Myers
Contractor: Well Water Systems, Inc.
Well No.: P-5
Weather: Partly Cloudy, 90 degrees F

Activity: Reverse-air drilling
Starting Depth: 480 feet bls

Bit Size: 7.875 inches
Ending Depth: 616 feet bls

<u>Time</u>	<u>Description</u>
0700	R. Dean onsite. Driller is onsite and preparing for reverse air drilling.
1120	Drilling reaches 492 feet
1320	Drilling reaches 523 feet bls. Specific capacity = 0.45 gpm/ft.
1445	Drilling reaches 554 feet bls. S.C. = 1.37 gpm/ft.
1657	Drilling reaches 585 feet bls. S.C. = 2.75 gpm/ft.
1805	Drilling reaches 616 feet bls. S.C. = 8 gpm/ft.
1830	Drilling activities are complete for the day.
1900	R. Dean leaves site for the day.

Recorded By: Randy Dean/CH2M HILL

Date : 7/24/00

CH2M HILL DAILY SUMMARY

Day/Date: Tuesday/7-25-00
Project No.: 157775.A1.03
Client: City of Ft. Myers
Contractor: Well Water Systems, Inc.
Well No.: P-5
Weather: Partly Cloudy, 90 degrees F

Activity: Reverse-air drilling
Starting Depth: 480 feet bls

Bit Size: 7.875 inches
Ending Depth: 832 feet bls

<u>Time</u>	<u>Description</u>
0700	R. Dean onsite. Driller is onsite and preparing for reverse air drilling. Static water level is 19.5 feet als.
0830	Drilling reaches 635 feet bls.
0915	Drilling reaches 647 feet bls. Specific capacity = 10.3 gpm/ft.
1015	Drilling reaches 677 feet bls. S.C. = 17.5 gpm/ft.
1110	Drilling reaches 708 feet bls. S.C. = 32 gpm/ft.
1310	Drilling reaches 739 feet bls. S.C. = 39.4 gpm/ft.
1453	Drilling reaches 770 feet bls. S.C. = 45.8 gpm/ft.
1600	Drilling reaches 801 feet bls. S.C. = 58 gpm/ft.
1700	B. Beddow instructs to continue drilling to 832 feet bls.
1845	Drilling reaches 832 feet bls. S.C. = 45.2 gpm/ft
1905	R. Dean to WTP to run water quality samples.
1920	R. Dean leaves site for the day.

Recorded By: Randy Dean/CH2M HILL

Date : 7/25/00

CH2M HILL DAILY SUMMARY

Day/Date: Wednesday/7-26-00
Project No.: 157775.A1.03
Client: City of Ft. Myers
Contractor: Well Water Systems, Inc.
Well No.: P-5
Weather: Partly Cloudy, 90 degrees F

Activity: None
Starting Depth: N/A

Bit Size: 7.875 inches
Ending Depth: None

<u>Time</u>	<u>Description</u>
0700	R. Dean arrives onsite. Driller is onsite and is waiting directions from Engineer. Static water level is 19.25 feet als.
0725	R. Dean notifies B. Balmer to close in well. No further drilling will take place before logging.
0830	Well is closed in. No further activity on this site until 0830 tomorrow.

Recorded By: Randy Dean/CH2M HILL

Date : 7/26/00

CH2M HILL DAILY SUMMARY

Day/Date: Thursday/7-27-00
Project No.: 157775.A1.03
Client: City of Ft. Myers
Contractor: Well Water Systems, Inc.
Well No.: P-5
Weather: Partly Cloudy, 95 degrees F

Activity: Geophysical Logging
Starting Depth: 0 feet bls

Bit Size: 7.875 inches
Ending Depth: 831 feet bls

<u>Time</u>	<u>Description</u>
0700	R. Dean arrives onsite. Driller is onsite. Static water level is 19' 8" als.
0800	MV Geophysical arrives onsite.
0830	Begin geophysical logging.
1400	Static and dynamic logs complete.
1425	MV Geophysical leaves site.

Recorded By: Randy Dean/CH2M HILL

Date : 7/27/00

CH2M HILL DAILY SUMMARY

Day/Date: Monday/7-31-00
Project No.: 157775.A1.03
Client: City of Ft. Myers
Contractor: Well Water Systems, Inc.
Well No.: P-5
Weather: Partly Cloudy, 95 degrees F

Activity: Reaming **Bit Size:** 13.25 inches
Starting Depth: 740 feet bls **Ending Depth:** 832 feet bls

<u>Time</u>	<u>Description</u>
0730	R. Dean arrives onsite. Driller is onsite. Reaming has reached 740 feet bls.
0900	R. Dean instructs Driller to ream to 832 feet bls.
1320	Reaming reaches 822 feet bls.
1345	Reaming reaches 832 feet bls. Driller will trip out until video logging tomorrow.

Recorded By: Randy Dean/CH2M HILL

Date : 7/31/00

CH2M HILL DAILY SUMMARY

Day/Date: Tuesday/8-1-00
Project No.: 157775.A1.03
Client: City of Ft. Myers
Contractor: Well Water Systems, Inc.
Well No.: P-5
Weather: Partly Cloudy, 95 degrees F

Activity: Geophysical Logging
Starting Depth: 0 feet bls

Bit Size: 13.25 inches
Ending Depth: 832 feet bls

<u>Time</u>	<u>Description</u>
0800	R. Dean arrives onsite. Driller is onsite.
0900	MV Geophysical arrives onsite.
0925	Begin video logging. Well is very cloudy. Fracture is producing sediment and making well too cloudy to video log the well. Well will be relogged.
1100	MV Geophysical leaves site.

Recorded By: Randy Dean/CH2M HILL

Date : 8/1/00

APPENDIX D.6

Well P-6 Daily Construction Reports

CH2M HILL DAILY SUMMARY

Day/Date: Monday/8-07-00
Project No.: 157775.A1.03
Client: City of Ft. Myers
Contractor: Well Water Systems, Inc.
Well No.: P-6
Weather: Partly Cloudy, 93 degrees F

Activity: Site Preparation **Bit Size:** N/A
Starting Depth: N/A **Ending Depth:** N/A

<u>Time</u>	<u>Description</u>
0700	R. Dean onsite. Driller is onsite. Driller is preparing rig and site for drilling.

Recorded By: Randy Dean/CH2M HILL

Date : 8/07/00

CH2M HILL DAILY SUMMARY

Day/Date: Tuesday/8-08-00
Project No.: 157775.A1.03
Client: City of Ft. Myers
Contractor: Well Water Systems, Inc.
Well No.: P-6
Weather: Partly Cloudy, 93 degrees F

Activity: Site Preparation
Starting Depth: N/A

Bit Size: N/A
Ending Depth: N/A

<u>Time</u>	<u>Description</u>
0700	R. Dean onsite. Driller is onsite. Driller is preparing rig and site for drilling.

Recorded By: Randy Dean/CH2M HILL

Date : 8/08/00

CH2M HILL DAILY SUMMARY

Day/Date: Wednesday/8-09-00
Project No.: 157775.A1.03
Client: City of Ft. Myers
Contractor: Well Water Systems, Inc.
Well No.: P-6
Weather: Partly Cloudy, 93 degrees F

Activity: Site Preparation **Bit Size:** N/A
Starting Depth: N/A **Ending Depth:** N/A

<u>Time</u>	<u>Description</u>
0700	R. Dean onsite. Driller is onsite. Driller is preparing rig and site for drilling.

Recorded By: Randy Dean/CH2M HILL Date : 8/09/00

CH2M HILL DAILY SUMMARY

Day/Date: Thursday/8-10-00
Project No.: 157775.A1.03
Client: City of Ft. Myers
Contractor: Well Water Systems, Inc.
Well No.: P-6
Weather: Partly Cloudy, 93 degrees F

Activity: Site Preparation
Starting Depth: N/A

Bit Size: N/A
Ending Depth: N/A

<u>Time</u>	<u>Description</u>
0700	R. Dean onsite. Driller is onsite. Driller is preparing to drill pilot hole.
0855	Driller reaches 92 feet bls. Logger will be onsite at 0930.
0925	MV Geophysical arrives onsite.
1040	Logging complete. Logger is not available until 10/16/00. Driller will wait to ream hole until 10/16/00. No work will be completed on this site until 10/16/00

Recorded By: Randy Dean/CH2M HILL

Date : 8/10/00

CH2M HILL DAILY SUMMARY

Day/Date: Wednesday/8-16-00
Project No.: 157775.A1.03
Client: City of Ft. Myers
Contractor: Well Water Systems, Inc.
Well No.: P-6
Weather: Partly Cloudy, 93 degrees F

Activity: Logging, Casing, Cementing **Bit Size:** N/A
Starting Depth: N/A **Ending Depth:** N/A

<u>Time</u>	<u>Description</u>
0800	R. Dean onsite. Driller is onsite. Driller is reaming pilot hole.
1300	MV Geophysical arrives onsite.
1345	Driller ready for logging.
1410	Logging begins. TD = 92 feet bls.
1420	Caliper arms (45") are not long enough to reach borehole wall. R. Dean requests adding 62" arms on caliper tool.
1450	Logging complete.
1500	MV Geophysical leaves site.
1605	26-inch steel casing set at 85 feet bls.
1710	79 feet tremmie pipe installed.
1736	Pumped batch #1 neat cement. 40 bags/14.7 lbs/gal
1748	Pumped batch #2 neat cement. 40 bags/15.1 lbs/gal
1800	Pumped batch #3 neat cement. 40 bags/15.1 lbs/gal
1812	Pumped batch #1 4% bentonite cement. 30 bags/14.3 lbs/gal
1825	Pumped batch #2 4% bentonite cement. 30 bags/13.7 lbs/gal
1840	Pumped batch #3 4% bentonite cement. 30 bags/13.8 lbs/gal
1854	Pumped batch #4 4% bentonite cement. 30 bags/14.0 lbs/gal
	TOTAL = 120 Bags Neat cement and 120 bags 4% bentonite
1900	R. Dean leaves site for the day.

Recorded By: Randy Dean/CH2M HILL

Date : 8/16/00

CH2M HILL DAILY SUMMARY

Day/Date: Thursday/8-17-00
Project No.: 157775.A1.03
Client: City of Ft. Myers
Contractor: Well Water Systems, Inc.
Well No.: P-6
Weather: Partly Cloudy, 93 degrees F

Activity: Cementing
Starting Depth: 42 feet bls
Bit Size: N/A
Ending Depth: 0 feet bls

<u>Time</u>	<u>Description</u>
0700	R. Dean onsite. Driller is onsite.
0730	Driller tags cement in annulus at 42 feet bls.
0755	Pumped batch #1 6% bentonite cement. 30 bags/13.3 lbs/gal
0815	Pumped batch #2 6% bentonite cement. 30 bags/13.3 lbs/gal
0830	Pumped batch #3 6% bentonite cement. 30 bags/13.3 lbs/gal
0904	Pumped batch #4 6% bentonite cement. 30 bags/13.1 lbs/gal
0925	Pumped batch #5 6% bentonite cement. 30 bags/13.3 lbs/gal
0955	Pumped batch #6 6% bentonite cement. 30 bags/13.3 lbs/gal
1033	Pumped batch #7 6% bentonite cement. 30 bags/13.4 lbs/gal
1055	Pumped batch #8 6% bentonite cement. 30 bags/12.6 lbs/gal Cement returns noted at surface. Approximately 10-15 bags were pumped.
1100	R. Dean leaves site.
1205	R. Dean returns to site.

Recorded By: Randy Dean/CH2M HILL

Date : 8/17/00

CH2M HILL DAILY SUMMARY

Day/Date: Friday/8-18-00
Project No.: 157775.A1.03
Client: City of Ft. Myers
Contractor: Well Water Systems, Inc.
Well No.: P-6
Weather: Partly Cloudy, 93 degrees F

Activity: Cementing, Drilling **Bit Size:** 7.785-inches
Starting Depth: 92 **Ending Depth:** 153 feet bls

<u>Time</u>	<u>Description</u>
0700	R. Dean onsite. Driller is onsite.
0730	Driller tags cement in annulus at 8 feet bls. Driller will top off cement. Driler is preparing to resume mud drilling of pilot hole.
1425	Drilling resumes.
1545	Drilling reaches 143 feet bls. R.Dean is informed by B. Balmer that drilling will cease today at 1600. R. Dean leaves site for the day.

Recorded By: Randy Dean/CH2M HILL

Date : 8/18/00

CH2M HILL DAILY SUMMARY

Day/Date: Monday/8-28-00
Project No.: 157775.A1.03
Client: City of Ft. Myers
Contractor: Well Water Systems, Inc.
Well No.: P-6
Weather: Sunny, 90 degrees F

Activity: Drilling
Starting Depth: 153 feet bls
Bit Size: 7.785-inches
Ending Depth: 357 feet bls

<u>Time</u>	<u>Description</u>
0700	R. Dean arrives onsite.
1000	Drilling resumes from 153 feet bls.
1615	Drilling reaches 357 feet bls. Drilling is complete for the day.
1730	R. Dean leaves site for the day.

Recorded By: Randy Dean/CH2M HILL

Date : 8/28/00

CH2M HILL DAILY SUMMARY

Day/Date: Wednesday/8-30-00
Project No.: 157775.A1.03
Client: City of Ft. Myers
Contractor: Well Water Systems, Inc.
Well No.: P-6
Weather: Sunny, 90 degrees F

Activity: Pilot-hole Drilling
Starting Depth: 357 feet bls
Bit Size: 7.785-inches
Ending Depth: 461 feet bls

<u>Time</u>	<u>Description</u>
0700	R. Dean onsite.
1015	Driller reaches bottom of pilot hole at 461 feet bls.
1405	MV Geophysical onsite
1620	Geophysical logging complete. Logging includes caliper, gamma, dual induction.
1720	MV Geophysical leaves site.
1800	R. Dean leaves site for the day.

Recorded By: Randy Dean/CH2M HILL

Date : 8/29/00

APPENDIX D.7

Well P-7 Daily Construction Reports

CH2M HILL DAILY SUMMARY

Day/Date: Tuesday/7-18-00
Project No.: 157775.A1.03
Client: City of Ft. Myers
Contractor: Well Water Systems, Inc.
Well No.: P-7
Weather: Partly Cloudy, 93 degrees F

Activity: Reaming surface casing pilot hole
Starting Depth: 0 feet bls

Bit Size: 30-inches
Ending Depth: 10 feet bls

<u>Time</u>	<u>Description</u>
0800	Dan J. onsite to P-7. WWS began drilling out pilot hole using a 30-inch diameter reaming bit. Swivel to kelly is leaking drilling fluid.
0815	TD = 4 feet bls.
1000	TD = 10 feet bls. WWS shut down drill rig. Swivel was leaking too much drilling fluid to continue to operate the drill rig. A new component to the swivel will arrive onsite tomorrow. Until then, the P-7 drill rig will be shut down.

Recorded By: Dan Jablonski/CH2M HILL

Date : 7/18/00

CH2M HILL DAILY SUMMARY

Day/Date: Wednesday/7-19-00
Project No.: 157775.A1.03
Client: City of Ft. Myers
Contractor: Well Water Systems, Inc.
Well No.: P-7
Weather: Partly Cloudy, 93 degrees F

Activity: Reaming surface casing pilot hole
Starting Depth: 10 feet bls

Bit Size: 30-inches
Ending Depth: ? feet bls

<u>Time</u>	<u>Description</u>
1400	Dan J. onsite to P-7. TD approx. 10 feet bls with reaming bit. Repairs have been completed to drill rig.

Recorded By: Dan Jablonski/CH2M HILL

Date : 7/19/00

CH2M HILL DAILY SUMMARY

Day/Date: Monday/7-24-00
Project No.: 157775.A1.03
Client: City of Ft. Myers
Contractor: Well Water Systems, Inc.
Well No.: P-7
Weather: Partly Cloudy, 93 degrees F

Activity: Pilot hole drilling
Starting Depth: 127 feet bls

Bit Size: 7.875-inches
Ending Depth: 345 feet bls

<u>Time</u>	<u>Description</u>
0700	R. Dean arrives onsite. Driller is onsite
1130	Drilling reaches 250 feet bls.
1500	Drilling reaches 345 feet bls. Mud shaker under repair.
1700	Driller leaves site for the day.

Recorded By: Randy Dean/CH2M HILL

Date : 7/24/00

CH2M HILL DAILY SUMMARY

Day/Date: Tuesday/7-25-00
Project No.: 157775.A1.03
Client: City of Ft. Myers
Contractor: Well Water Systems, Inc.
Well No.: P-7
Weather: Partly Cloudy, 93 degrees F

Activity: Pilot hole drilling
Starting Depth: 345 feet bls

Bit Size: 7.875-inches
Ending Depth: 438 feet bls

<u>Time</u>	<u>Description</u>
0700	R. Dean arrives onsite. Driller is onsite
1030	Drilling reaches 362 feet bls. Mud shaker under repair.
1605	Drilling reaches 410 feet bls.
1725	Drilling reaches 435 feet bls.
1740	Drilling reaches 438 feet bls. Mud shaker under repair. B. Balmer states that drilling activities are complete for the day.

Recorded By:

Randy Dean/CH2M HILL

Date : 7/25/00

CH2M HILL DAILY SUMMARY

Day/Date: Wednesday/7-26-00
Project No.: 157775.A1.03
Client: City of Ft. Myers
Contractor: Well Water Systems, Inc.
Well No.: P-7
Weather: Partly Cloudy, 93 degrees F

Activity: Pilot hole drilling, geophysical logging **Bit Size:** 7.875-inches
Starting Depth: 438 feet bls **Ending Depth:** 470 feet bls

<u>Time</u>	<u>Description</u>
0700	R. Dean arrives onsite. Driller is onsite. B. Balmer states that mud shaker is still down and drilling should resume around 0930.
1045	Drilling reaches 470 feet bls. B. Beddow decides to stop drilling. MV Geophysical to be onsite at 1500.
1245	R. Dean leaves site for lunch.
1345	R. Dean returns to site.
1600	R. Dean contacts MV Geophysical. MV states they will be onsite at 1800.
1700	MV verifies they will be onsite at 1800. R. Dean leaves site.
1745	R. Dean returns to site.
1805	MV Geophysical onsite.
1825	Begin gamma/caliper logging.
1905	Begin Dual induction logging.
1935	Geophysical logging complete.
2000	R. Dean, Driller, MV Geophysical leave site for the day

Recorded By: Randy Dean/CH2M HILL

Date : 7/26/00

CH2M HILL DAILY SUMMARY

Day/Date: Thursday/7-27-00
Project No.: 157775.A1.03
Client: City of Ft. Myers
Contractor: Well Water Systems, Inc.
Well No.: P-7
Weather: Partly Cloudy, 93 degrees F *

Activity: Sand backfill
Starting Depth: 470 feet bls
Bit Size: 7.875-inches
Ending Depth:

<u>Time</u>	<u>Description</u>
0700	R. Dean arrives onsite. Driller is onsite.
0800	R. Dean informs B. Balmer of plans to backfill pilot hole with sand and cement.
0855	R. Dean speaks with B. Beddow about final backfill plan. Fill with sand to 453 feet bls with sand. Top with 10 bags neat cement.
1026	Sand arrives onsite. Notify B. Balmer to put sand to 453 feet bls and set casing at 445 feet bls.
1115	Place 19 bags sand in well.
1125	Place 5 bags sand in well. Letting sand settle in well.
1400	B. Balmer states that drill rod is plugged. Tripping out to unplug.
1415	Pipe cleared. Driller cleans sand from hole down to 454 feet bls.
1425	Begin pumping 10 bags neat cement.
1440	Begin pumping water chase. No further work on this site today.
1700	R. Dean leaves site for the day.

Recorded By: Randy Dean/CH2M HILL

Date : 7/27/00

CH2M HILL DAILY SUMMARY

Day/Date: Friday/7-28-00
Project No.: 157775.A1.03
Client: City of Ft. Myers
Contractor: Well Water Systems, Inc.
Well No.: P-7
Weather: Partly Cloudy, 93 degrees F

Activity: Cement tag/Reaming
Starting Depth:

Bit Size: 24-inches
Ending Depth:

<u>Time</u>	<u>Description</u>
0700	R. Dean arrives onsite. Driller is onsite.
0800	Driller tags cement at 426 feet bls. Driller is tripping out and will begin reaming.
0800	R. Dean leaves site for the day.

Recorded By: Randy Dean/CH2M HILL

Date : 7/28/00

CH2M HILL DAILY SUMMARY

Day/Date: Monday/7-31-00
Project No.: 157775.A1.03
Client: City of Ft. Myers
Contractor: Well Water Systems, Inc.
Well No.: P-7
Weather: Partly Cloudy, 93 degrees F

Activity: Reaming **Bit Size:** 24-inches
Starting Depth: 127 feet bls **Ending Depth:** 281 feet bls

<u>Time</u>	<u>Description</u>
0730	R. Dean arrives onsite. Driller is onsite. Driller states that sand at approximately 120 feet bls closed in over the weekend.
1325	Reaming reaches 221 feet bls.
1700	R. Dean leaves site for the day.

Recorded By: Randy Dean/CH2M HILL

Date : 7/31/00

CH2M HILL DAILY SUMMARY

Day/Date: Tuesday/8-01-00
Project No.: 157775.A1.03
Client: City of Ft. Myers
Contractor: Well Water Systems, Inc.
Well No.: P-7
Weather: Partly Cloudy, 93 degrees F

Activity: Reaming **Bit Size:** 24-inches
Starting Depth: 281 feet bls **Ending Depth:** 434 feet bls

<u>Time</u>	<u>Description</u>
0800	R. Dean arrives onsite. Driller is onsite. Driller states that sand at approximately 120 feet bls closed in over the weekend.
1700	Reaming reaches 434 feet bls. Strong thunderstorm. Drilling stops for the day.
1730	R. Dean leaves site for the day.

Recorded By: Randy Dean/CH2M HILL

Date : 8/01/00

CH2M HILL DAILY SUMMARY

Day/Date: Wednesday/8-02-00
Project No.: 157775.A1.03
Client: City of Ft. Myers
Contractor: Well Water Systems, Inc.
Well No.: P-7
Weather: Partly Cloudy, 93 degrees F

Activity: Reaming **Bit Size:** 24-inches
Starting Depth: 434 feet bls **Ending Depth:** 448 feet bls

<u>Time</u>	<u>Description</u>
0700	R. Dean arrives onsite. Driller is onsite.
1000	Reaming reaches 448 feet bls. Driller will ream to bottom and complete wiper pass. Driller will complete final wiper pass tomorrow prior to logging.
1930	R. Dean leaves site for the day.

Recorded By: Randy Dean/CH2M HILL

Date : 8/02/00

CH2M HILL DAILY SUMMARY

Day/Date: Thursday/8-03-00
Project No.: 157775.A1.03
Client: City of Ft. Myers
Contractor: Well Water Systems, Inc.
Well No.: P-7
Weather: Partly Cloudy, 93 degrees F

Activity: Logging, Installing Casing, Cementing
Starting Depth:
Bit Size:
Ending Depth:

<u>Time</u>	<u>Description</u>
0700	R. Dean arrives onsite. Driller is onsite.
0820	MV Geophysical arrives onsite. Driller is rereaming hole and will begin to trip out of hole shortly.
1040	Driller has removed all tools from well.
1057	Logger tags bottom at 449 feet bls.
1200	MV Geophysical leaves site.
1235	Begin installing 16-inch SDR-17 PVC casing to a depth of 445 feet bls.
1440	Casing installed in well.
1645	Driller starts mixing batch 1 of 3 of 4% bentonite grout.
1700	Driller pumps first batch of grout. 13.5 lbs/gal.
1705	Begin mixing batch 2 of 3. 13.4 lbs/gal.
1727	Pumping batch 3 of 3 of 4% grout. 13.5 lbs/gal. Pumped total of 90 bags 4% grout.
1747	Pumping batch 1 of 3 of neat cement. 47 bags. 15.4 lbs/gal.
1759	Pumping batch 2 of 3 of neat cement. 42 bags. 15.5 lbs/gal.
1812	Pumping batch 3 of 3 of neat cement. 42 bags. 15.4 lbs.gal. Pumped total of 131 bags neat cement.
1900	R. Dean leaves site for the day

Recorded By: Randy Dean/CH2M HILL

Date : 8/03/00

CH2M HILL DAILY SUMMARY

Day/Date: Friday/8-04-00
Project No.: 157775.A1.03
Client: City of Ft. Myers
Contractor: Well Water Systems, Inc.
Well No.: P-7
Weather: Partly Cloudy, 93 degrees F

Activity: Cementing
Starting Depth:

Bit Size:
Ending Depth:

<u>Time</u>	<u>Description</u>
0700	R. Dean arrives onsite. Driller is onsite.
0730	Driller tags inside of casing at 435.75 feet bls.
0930	Driller tags backside of casing at 200 feet bls.
1030	Driller tags frontside of casing at 165 feet bls. Driller will try to jet through clay to get to cement tag.
1140	Driller is set up to circulate mud to get through clay. Tremmie is set at 180 feet bls.
1212	Tremmie reaches 189 feet bls.
1232	Tremmie reaches 206 feet bls.
1400	Begin mixing 4% bentonite grout.
1420	Pump batch #1 – 48 bags grout. 15.1 lbs/gal.
1435	Pump batch #2 – 30 bags 4%. 15.4 lbs/gal.
1453	Pump batch #3 – 30 bags 4%. 14.7 lbs/gal.
1507	Pump batch #4 – 30 bags 4%. 14.7 lbs/gal.
1525	Pump batch #5 – 30 bags 4%. 15.0 lbs/gal.
1527	Begin mixing batch #6 – 30 bags 4%. 14.7 lbs/gal.
1600	R. Dean leaves site for day.

Recorded By: Randy Dean/CH2M HILL

Date : 8/04/00

CH2M HILL DAILY SUMMARY

Day/Date: Thursday/8-10-00
Project No.: 157775.A1.03
Client: City of Ft. Myers
Contractor: Well Water Systems, Inc.
Well No.: P-7
Weather: Partly Cloudy, 93 degrees F

Activity: Reverse-Air Drilling **Bit Size:** 7.785-inches
Starting Depth: 502 feet bls **Ending Depth:** 502 feet bls

<u>Time</u>	<u>Description</u>
0700	R. Dean onsite. Driller is onsite.
0900	Driller reaches 533 feet bls.
1025	Begin specific capacity test.
1043	End specific capacity test. S.C. = 14.8 gpm/ft. Drillin rig is down. Driller is repairing rig for remainder of day.

Recorded By: Randy Dean/CH2M HILL

Date : 8/10/00

CH2M HILL DAILY SUMMARY

Day/Date: Thursday/8-17-00
Project No.: 157775.A1.03
Client: City of Ft. Myers
Contractor: Well Water Systems, Inc.
Well No.: P-7
Weather: Partly Cloudy, 93 degrees F

Activity: Cementing
Starting Depth: 42 feet bls
Bit Size: N/A
Ending Depth: 0 feet bls

<u>Time</u>	<u>Description</u>
0700	R. Dean onsite. Driller is onsite.
0730	Driller tags cement in annulus at 42 feet bls.
0755	Pumped batch #1 6% bentonite cement. 30 bags/13.3 lbs/gal
0815	Pumped batch #2 6% bentonite cement. 30 bags/13.3 lbs/gal
0830	Pumped batch #3 6% bentonite cement. 30 bags/13.3 lbs/gal
0904	Pumped batch #4 6% bentonite cement. 30 bags/13.1 lbs/gal
0925	Pumped batch #5 6% bentonite cement. 30 bags/13.3 lbs/gal
0955	Pumped batch #6 6% bentonite cement. 30 bags/13.3 lbs/gal
1033	Pumped batch #7 6% bentonite cement. 30 bags/13.4 lbs/gal
1055	Pumped batch #8 6% bentonite cement. 30 bags/12.6 lbs/gal Cement returns noted at surface. Approximately 10-15 bags were pumped.
1100	R. Dean leaves site.
1205	R. Dean returns to site.

Recorded By: Randy Dean/CH2M HILL

Date : 8/17/00

CH2M HILL DAILY SUMMARY

Day/Date: Friday/8-18-00
Project No.: 157775.A1.03
Client: City of Ft. Myers
Contractor: Well Water Systems, Inc.
Well No.: P-7
Weather: Partly Cloudy, 93 degrees F

Activity: Cementing, Drilling
Starting Depth: 92 feet bls
Bit Size: 7.785-inches
Ending Depth: 153 feet bls

<u>Time</u>	<u>Description</u>
0700	R. Dean onsite. Driller is onsite.
0730	Driller tags cement in annulus at 8 feet bls. Driller will top off cement. Driler is preparing to resume mud drilling of pilot hole.
1425	Drilling resumes.
1645	Drilling reaches 143 feet bls. R.Dean is informed by B. Balmer that drilling will not go past 153 feet bls today. R. Dean leaves site for the day.

Recorded By: Randy Dean/CH2M HILL

Date : 8/18/00

CH2M HILL DAILY SUMMARY

Day/Date: Monday/8-21-00
Project No.: 157775.A1.03
Client: City of Ft. Myers
Contractor: Well Water Systems, Inc.
Well No.: P-7
Weather: Partly Cloudy, 93 degrees F

Activity: Cementing, Drilling
Starting Depth: 92 feet bls
Bit Size: 7.785-inches
Ending Depth: 153 feet bls

<u>Time</u>	<u>Description</u>
-------------	--------------------

Recorded By: Randy Dean/CH2M HILL

Date : 8/21/00

CH2M HILL DAILY SUMMARY

Day/Date: Tuesday/8-29-00
Project No.: 157775.A1.03
Client: City of Ft. Myers
Contractor: Well Water Systems, Inc.
Well No.: P-7
Weather: Partly Cloudy, 93 degrees F

Activity: Pilot-hole Drilling **Bit Size:** 7.785-inches
Starting Depth: 153 feet bls **Ending Depth:** 461 feet bls

<u>Time</u>	<u>Description</u>
0700	R. Dean onsite.

Recorded By: Randy Dean/CH2M HILL

Date : 8/29/00

APPENDIX E

Casing Mill Certificates

검사 증명서(A)

MILL INSPECTION CERTIFICATE

현대강관주식회사
HYUNDAI PIPE CO.,LTD.
 HEAD OFFICE: 4381 YUHOONG, P.O. BOX 10, YONGIN, KOREA
 (U.S.A. BRANCH) TEL: 800-368-7788 FAX: 800-368-7788

CONTRACT NO.: E-9-12-61
 DATE OF ORDER: DEC. 28, 1998
 CONTRACT SPEC.: E483200
 COMPANY: E.R.E. THE CITY
 PROJECT: 121-8271-1 SANJON JUSANG 5438

시공사: 유스시공(주) 770-7700 (115-3128)
 SOIL OFFICE: 71, HUSYONGONG, JOONG-GIL, SEONG, KOREA
 TEL: 345-0388 FAX: 778-7888

PIPE SIZE	DIMENSION (OUTER - THICK - SPACING)	QUANTITY	WEIGHT	GRADE	SPECIFICATION	TEST	RELAT NO	TENSILE TEST			CHEMICAL COMPOSITION						
								YIELD	TENSILE	ELONG	C	Mn	P	S	Si	Cr	Ni
20"	20" x 0.531" x 12.000"	22	379.058	68 G G G G G	G	W3338	4570	31.4	49.5	52.4	19.2	75	15.00	2.1	1.0	2	
20"	20" x 0.531" x 12.000"	1100				W3337	4470	31.4	47.4	50.2	18.1	79	15.8	2.2	2.0	1	
20"	20" x 0.531" x 12.000"					W3338	4470	31.8	47.3	50.0	19.1	79	12.5	2.1	1.0	2	
20"	20" x 0.531" x 12.000"	32	18.748	68 G G G G G	G	W3337	4400	31.7	46.1	48.0	15.2	67	15.7	4.1	2.1	1	
20"	20" x 0.531" x 12.000"					W3338	4370	31.8	47.4	50.3	16.2	50	10.5	3.1	2.0	1	
20"	20" x 0.531" x 12.000"	2	23.378	68 G G G G G	G	W3337	4400	31.7	46.1	48.0	15.2	67	15.7	4.1	2.1	1	
TOTAL		352	281.824				4300										

REMARKS

NOTES

Post-R^o Fax No: 7871

Date: 5-1-01

To: Bobby

From: Aww

Co/Dept:

Co:

Phone #

Phone: 613-425-2116

Fax #

Fax #

THESE MILL TEST REPORTS APPLY TO YOUR P.O.# City of Myers

BARTON STEEL REF.# 21352

WE CERTIFY THAT THE DESCRIBED MATERIAL HAS BEEN PRODUCED IN ACCORDANCE WITH THE PRESCRIBED SPECIFICATION AND ORDER.

HYUNDAI PIPE CO., LTD.

APPENDIX F

Geophysical Logs

See Volume II for Full Geophysical Logs

Report: Appendix F for the Engineering Report on the Construction and Testing of Production Wells P-3 through P-7, Fort Myers, Florida

Well	Log Name	Date	Depths	
			Bottom	Top
P-3, E1		05/15/2000	0001	0101
P-3, E2	Caliper	05/16/2000	0009	0098
P-3, E3	X-Y Caliper, Gamma Ray	05/25/2000	0546	0000
	Dual Induction LL3/SP	05/19/2000	0546	0000
P-3, E4	X-Y Caliper, Gamma Ray	05/25/2000	0519	0000
P-3, E5	Fluid Resistivity Temperature	06/12/2000	0892	0000
	Dual Induction LL3/SP	06/12/2000	0890	0000
	Flowmeter	06/12/2000	0892	0000
	Flowmeter Interpretation	06/12/2000	0892	0493
	X-Y Caliper, Gamma Ray	06/12/2000	0889	0000
P-3, E6	X-Y Caliper, Gamma Ray	06/21/2000	0833	0025
P-4, E1		05/15/2000	0001	0100
P-4, E2	Caliper	05/16/2000	0008	0099
P-4, E3	X-Y Caliper, Gamma Ray	05/19/2000	0560	0000
	Dual Induction LL3/SP	05/19/2000	0560	0090
P-4, E4	X-Y Caliper, Gamma Ray	05/31/2000	0513	0000
	X-Y Caliper, Gamma Ray	06/01/2000	0513	0000
P-4, E5	Flowmeter	06/14/2000	0894	0445
	Flowmeter Interpretation	06/14/2000	0894	0489
	Dual Induction LL3/SP	06/14/2000	0892	0510
	X-Y Caliper, Gamma Ray	06/14/2000	0894	0000
	Fluid Resistivity Temperature	06/14/2000	0894	0000
P-4, E6	X-Y Caliper, Gamma Ray	06/21/2000	0822	0000
P-5, E1	Dual Induction LL3/SP	07/03/2000	0106	0000
	X-Y Caliper, Gamma Ray	07/03/2000	0105	0000
P-5, E2	X-Y Caliper, Gamma Ray	07/06/2000	0098	0000
P-5, E3	Dual Induction LL3/SP	07/12/2000	0521	0092
	X-Y Caliper, Gamma Ray	07/12/2000	0520	0000
P-5, E4	X-Y Caliper, Gamma Ray	07/18/2000	0488	0000
P-5, E5	Flowmeter Interpretation	07/27/2000	0831	0000
	Dual Induction LL3/SP	07/27/2000	0828	0000
	Flowmeter	07/27/2000	0831	0000
	X-Y Caliper, Gamma Ray	07/27/2000	0828	0000
	Fluid Resistivity Temperature	07/27/2000	0828	0000
P-5, E6	X-Y Caliper, Gamma Ray	08/02/2000	0828	0000
P-6, E1	Dual Induction LL3/SP	08/10/2000	0086	0000
	X-Y Caliper, Gamma Ray	08/10/2000	0086	0000
	X-Y Caliper, Gamma Ray	08/16/2000	0092	0000
P-6, E3	Dual Induction LL3/SP	08/29/2000	0459	0085
	X-Y Caliper, Gamma Ray	08/29/2000	0458	0000
P-6, E4	X-Y Caliper, Gamma Ray	09/05/2000	0453	0000
P-6, E5	X-Y Caliper, Gamma Ray	09/14/2000	0799	0000
	Dual Induction LL3/SP	09/14/2000	0800	0445
	Fluid Resistivity Temperature	09/14/2000	0802	0000
	Flowmeter	09/14/2000	0802	0400
	Flowmeter Interpretation	09/14/2000	0802	0400
P-6, E6	X-Y Caliper, Gamma Ray	09/19/2000	0800	0000

**Report: Appendix F for the Engineering Report on the Construction and Testing of
Production Wells P-3 through P-7, Fort Myers, Florida**

Well	Log Name	Date		Depths
P-7, E1	X-Y Caliper, Gamma Ray	07/10/2000	0103	0000
	Dual Induction LL3/SP	07/10/2000	0104	0000
P-7, E2	X-Y Caliper, Gamma Ray	07/20/2000	0080	0000
P-7, E3	X-Y Caliper, Gamma Ray	07/26/2000	0467	0000
	Dual Induction LL3/SP	07/26/2000	0466	0075
P-7, E4	X-Y Caliper, Gamma Ray	08/03/2000	0447	0000
P-7, E5	X-Y Caliper, Gamma Ray	08/17/2000	0795	0000
	Flowmeter Interpretation	08/17/2000	0796	0400
	Flowmeter	08/17/2000	0796	0400
	Dual Induction LL3/SP	08/17/2000	0796	0445
	Fluid Resistivity Temperature	08/17/2000	0795	0000
P-7, E-6	X-Y Caliper, Gamma Ray	08/23/2000	0795	0000

APPENDIX G

Video Surveys

APPENDIX G.1

Video Survey Summary

**Fort Myers MWTP
Production Well P-3
Video Survey Summary**

Date: 21-Jun-00
Observer: Randy Dean

Depth in feet below pad level		Observations
From	To	
0	100	Casing joints at 20 feet, 40 feet, 60 feet, 80 feet, and 100 feet bls.
100	200	Casing joints at 120 feet, 140 feet, 160 feet, 180 feet, and 200 feet bls.
200	300	Casing joints at 220 feet, 240 feet, 260 feet, 280 feet, and 300 feet bls.
300	400	Casing joints at 320 feet, 340 feet, 360 feet, 380 feet, and 400 feet bls.
400	500	Casing joint at 420 feet, 440 feet, 460 feet, 480 feet, and 500 feet bls.
500	510	Bottom of casing at 510 feet bls.
510	600	Gauged borehole.
600	700	Gauged borehole. Cavernous flow zone at 688 feet bls.
700	800	Gauged borehole. Cavernous flow zone at 724 feet bls.
800	836	Gauged borehole. Bottom of borehole at 836 feet bls.

bls=below land surface

**Fort Myers MWTP
Production Well P-4
Video Survey Summary**

Date: 21-Jun-00
Observer: Randy Dean

Depth in feet below pad level		Observations
From	To	
0	100	Casing joints at 20 feet, 40 feet, 60 feet, 80 feet, and 100 feet bls.
100	200	Casing joints at 120 feet, 140 feet, 160 feet, 180 feet, and 200 feet bls.
200	300	Casing joints at 220 feet, 240 feet, 260 feet, 280 feet, and 300 feet bls.
300	400	Casing joints at 320 feet, 340 feet, 360 feet, 380 feet, and 400 feet bls.
400	500	Casing joint at 420 feet, 440 feet, 460 feet, 480 feet, and 500 feet bls.
500	510	Bottom of casing at 510 feet bls.
510	600	Gauged borehole.
600	700	Gauged borehole. Cavernous flow zone at 670 feet bls.
700	800	Gauged borehole. Fracture at 736 feet bls.
800	825	Gauged borehole. Bottom of borehole at 825 feet bls.

bls=below land surface

**Fort Myers MWTP
Production Well P-5
Video Survey Summary**

Date: 2-Aug-00
Observer: Randy Dean

Depth in feet below pad level		Observations
From	To	
0	100	Casing joints at 20 feet, 40 feet, 60 feet, 80 feet, and 100 feet bls.
100	200	Casing joints at 120 feet, 140 feet, 160 feet, 180 feet, and 200 feet bls.
200	300	Casing joints at 220 feet, 240 feet, 260 feet, 280 feet, and 300 feet bls.
300	400	Casing joints at 320 feet, 340 feet, 360 feet, 380 feet, and 400 feet bls.
400	480	Casing joint at 420 feet, 440 feet, 460 feet, and 480 feet bls. Bottom of casing at 480 feet bls.
480	500	Bottom of casing at 510 feet bls.
500	600	Gauged borehole.
600	700	Gauged borehole. Cavernous flow zone at 638 feet bls. Small fracture producing sand/silt at 678 feet bls.
700	800	Gauged borehole.
800	832	Gauged borehole. Bottom of borehole at 832 feet bls.

bls=below land surface

**Fort Myers MWTP
Production Well P-6
Video Survey Summary**

Date: 19-Sep-00
Observer: Randy Dean

Depth in feet below pad level		Observations
From	To	
0	100	Casing joints at 20 feet, 40 feet, 60 feet, 80 feet, and 100 feet bls.
100	200	Casing joints at 120 feet, 140 feet, 160 feet, 180 feet, and 200 feet bls.
200	300	Casing joints at 220 feet, 240 feet, 260 feet, 280 feet, and 300 feet bls.
300	400	Casing joints at 320 feet, 340 feet, 360 feet, 380 feet, and 400 feet bls.
400	445	Casing joint at 420 feet and 440 feet bls. Bottom of casing at 445 feet bls.
445	500	Gauged borehole.
500	600	Gauged borehole.
600	700	Gauged borehole. Cavernous flow zone at 638 feet bls.
700	800	Gauged borehole. Cavernous flow zone at 712 feet bls. Bottom of borehole at 800 feet bls.
800	805	Bottom of borehole at 805 feet bls.

bls=below land surface

**Fort Myers MWTP
Production Well P-7
Video Survey Summary**

Date: 23-Aug-00
Observer: Randy Dean

Depth in feet below pad level		Observations
From	To	
0	100	Casing joints at 20 feet, 40 feet, 60 feet, 80 feet, and 100 feet bls.
100	200	Casing joints at 120 feet, 140 feet, 160 feet, 180 feet, and 200 feet bls.
200	300	Casing joints at 220 feet, 240 feet, 260 feet, 280 feet, and 300 feet bls.
300	400	Casing joints at 320 feet, 340 feet, 360 feet, 380 feet, and 400 feet bls.
400	445	Casing joint at 420 feet and 440 feet bls. Bottom of casing at 445 feet bls.
445	500	Gauged borehole.
500	600	Gauged borehole.
600	700	Gauged borehole. Cavernous flow zone at 628 feet bls.
700	800	Gauged borehole. Cavernous flow zone at 704 feet bls. Bottom of borehole at 800 feet bls.

bls=below land surface

APPENDIX G.2

Video Survey

See Volume III for Borehole Video Tapes

APPENDIX H

Pumping Tests Water Level Data

**Fort Myers Well P-3 Pumping Test
Wells P-3 and P-4 Water Level Data
November 1-5, 2000**

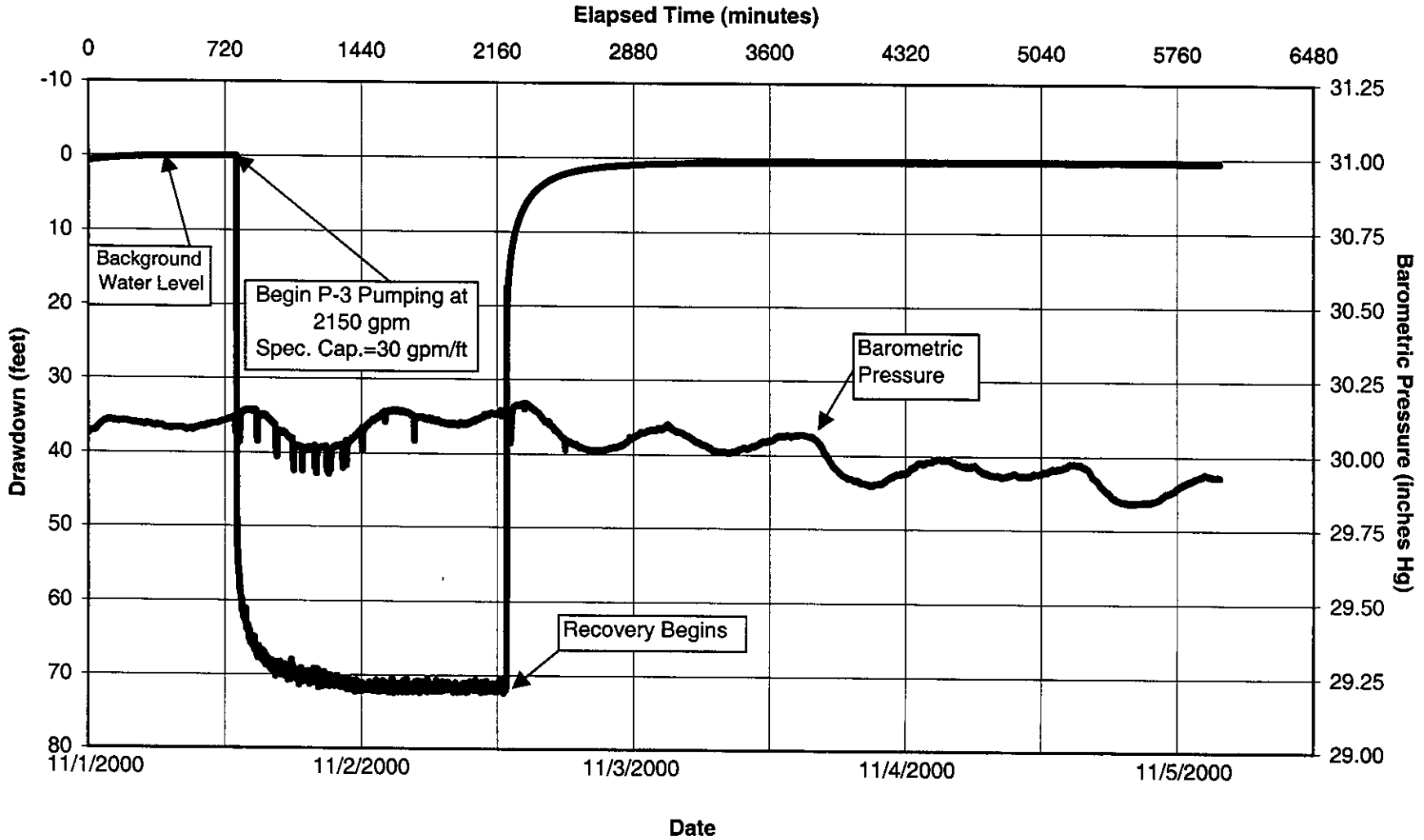

2M HILL CONSTRUCTORS, INC.

CONTINGENCY LOG

PROJECT NO. 155074

DATE PRINTED 04/03/2001

PROJECT NAME Hillsborough River WTP Expansion

CONTINGENCY AMOUNT \$ 1,300,000.00

REQUEST NUMBER	REQUESTED BY		DATE	DESCRIPTION	AMOUNT REQUESTED	STATUS	DATE APPROVED	AMOUNT APPROVED	APP AMOUNT	PEN AMOUNT	REJ AMOUNT
	CONTR.	OWNER									
1	X		10/09/00	Pre-Con / pile operations	91,284.37	APP	11/22/2000	91,284.37	\$91,284.37	\$0.00	\$0.00
2	X		10/24/00	PCI Wedeco - flow control loops to ozone diffusers	58,520.04	APP	11/22/2000	58,520.04	\$58,520.04	\$0.00	\$0.00
3									\$0.00	\$0.00	\$0.00
4									\$0.00	\$0.00	\$0.00
5									\$0.00	\$0.00	\$0.00
6									\$0.00	\$0.00	\$0.00
7									\$0.00	\$0.00	\$0.00
8									\$0.00	\$0.00	\$0.00
9									\$0.00	\$0.00	\$0.00
0									\$0.00	\$0.00	\$0.00
									\$149,804.41	\$0.00	\$0.00

STATUS

	CODE	AMOUNT
APPROVED	APP	\$149,804.41
PENDING	PEN	\$0.00
REJECTED	REJ	\$0.00
REMAINING CONTINGENCY		1,150,195.59

**Fort Myers Well P-3 Pumping Test
Well P-4 Water Level Data
November 1-5, 2000**

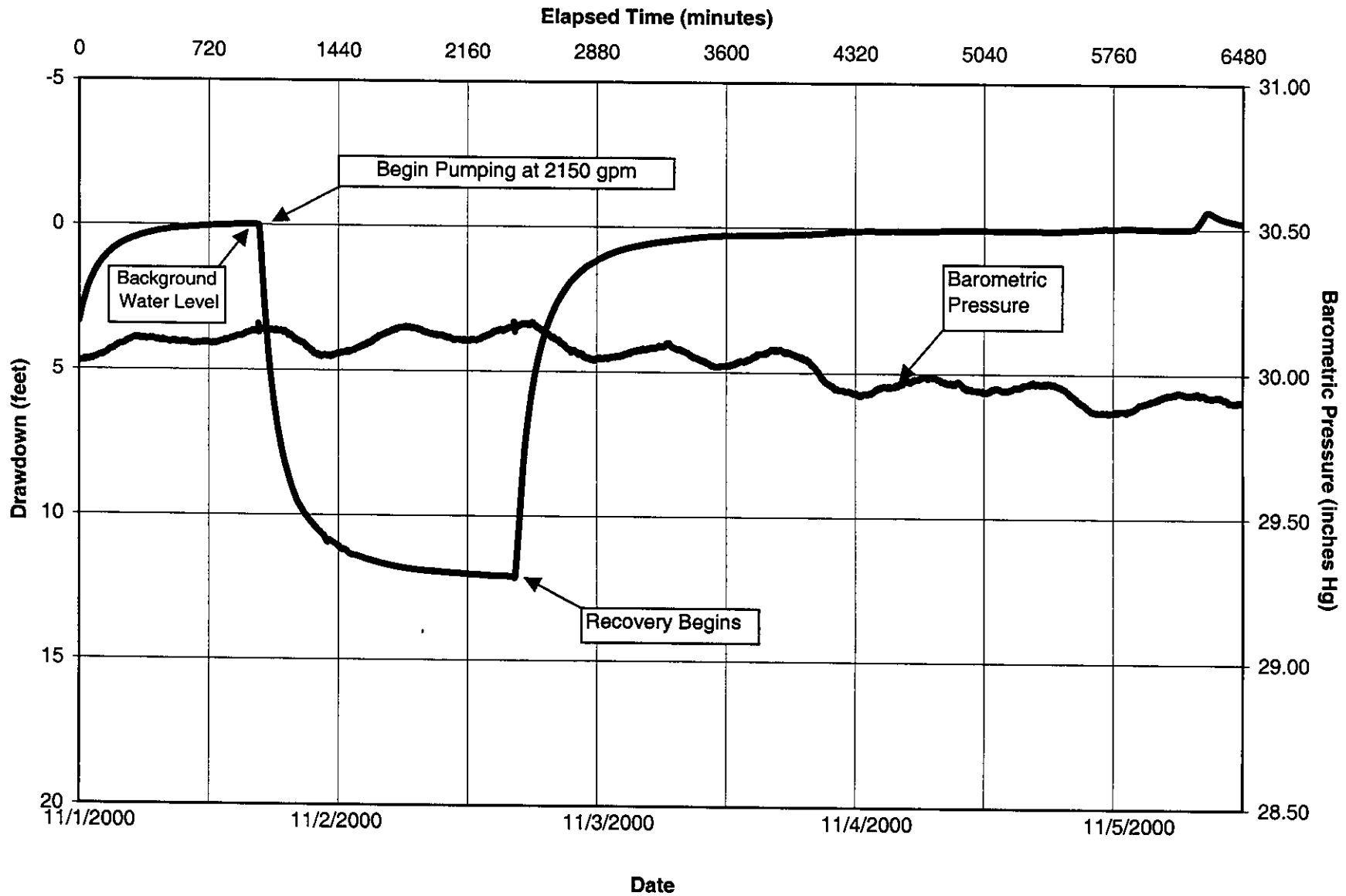

**Fort Myers Well P-4 Pumping Test
Well P-4 Water Level Data
November 8-13, 2000**

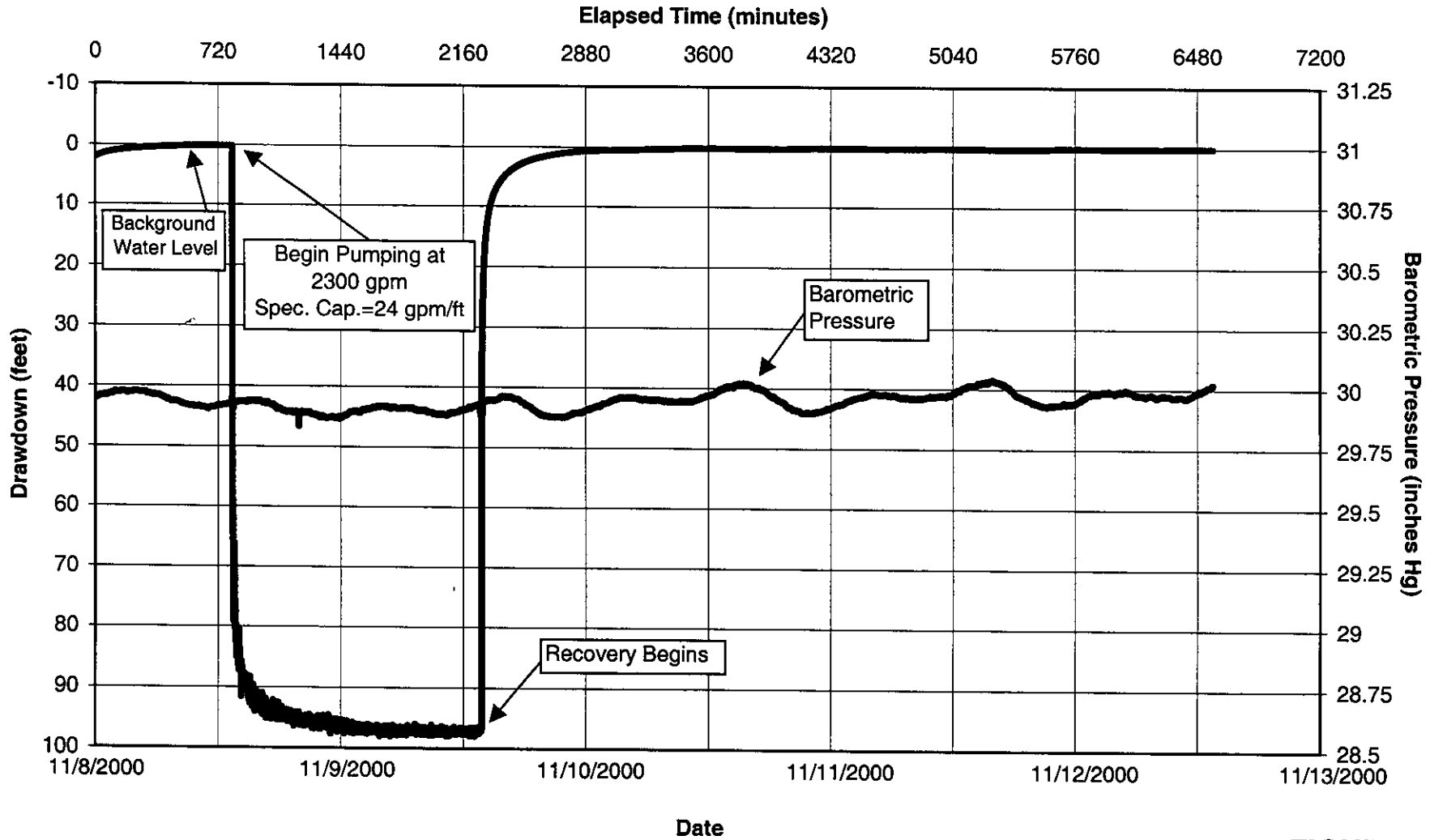

**Fort Myers Well P-4 Pumping Test
Well P-3 Water Level Data
November 8-13, 2000**

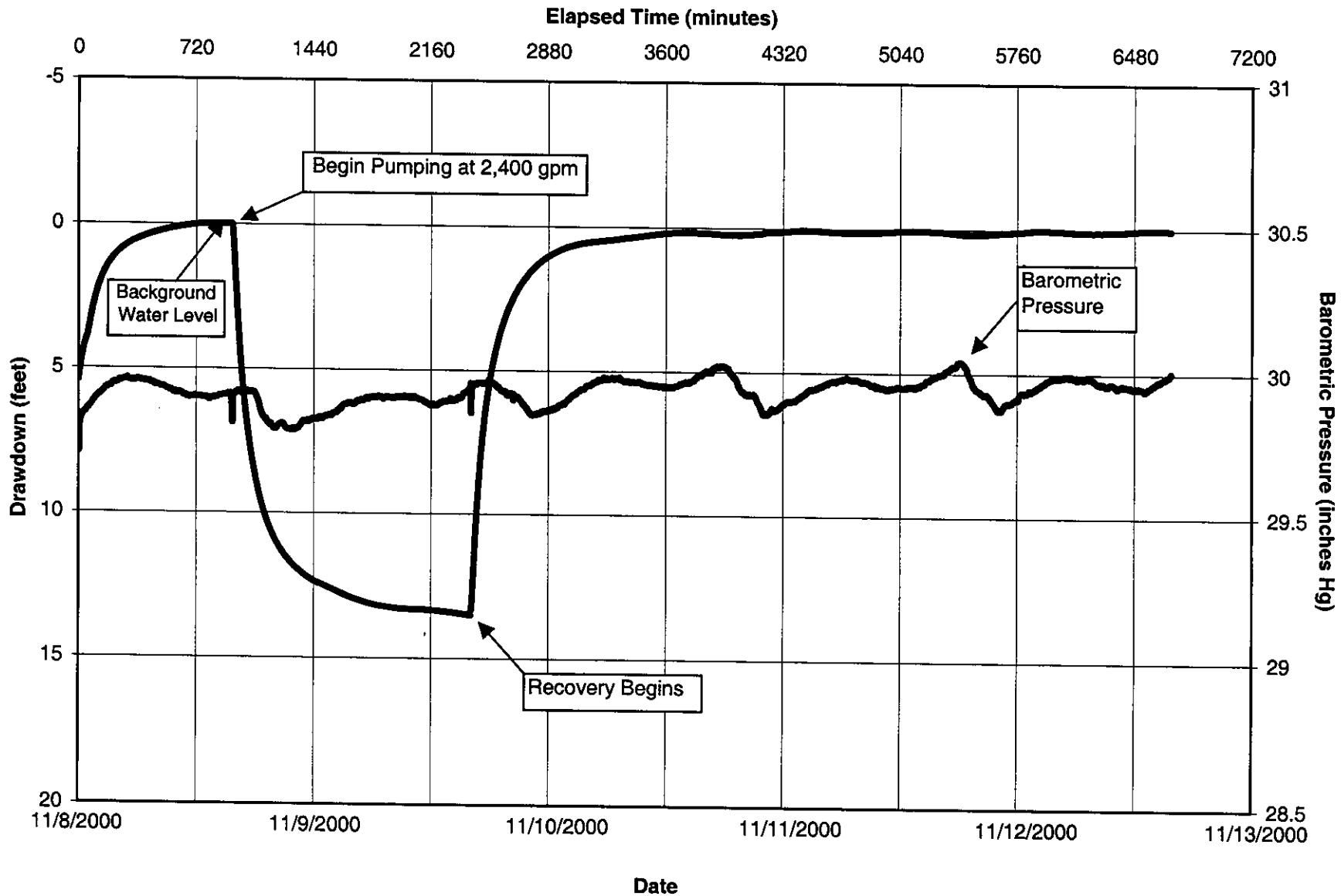

**Fort Myers Well P-5 Pumping Test
Well P-5 Water Level Data
November 27-December 5, 2000**

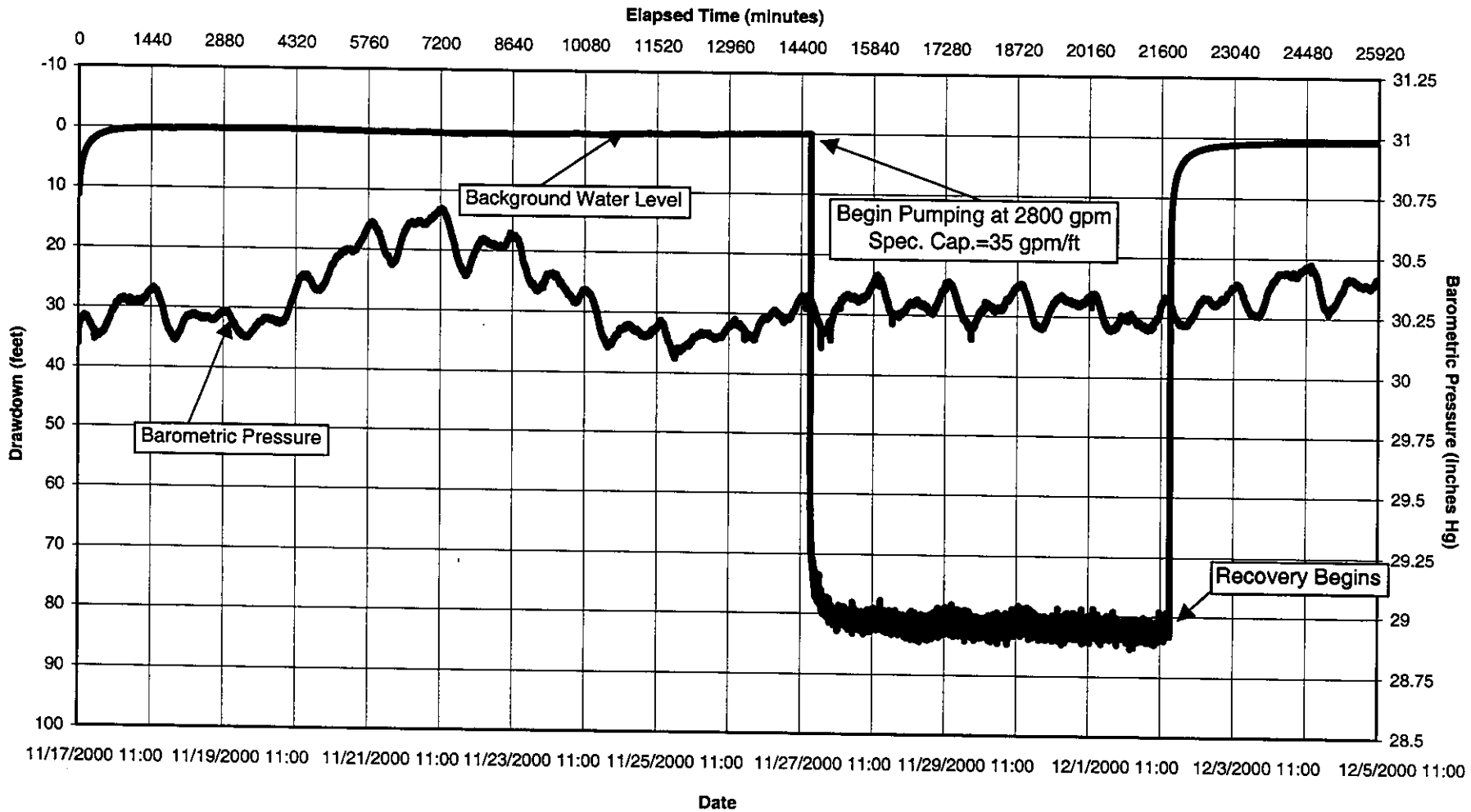
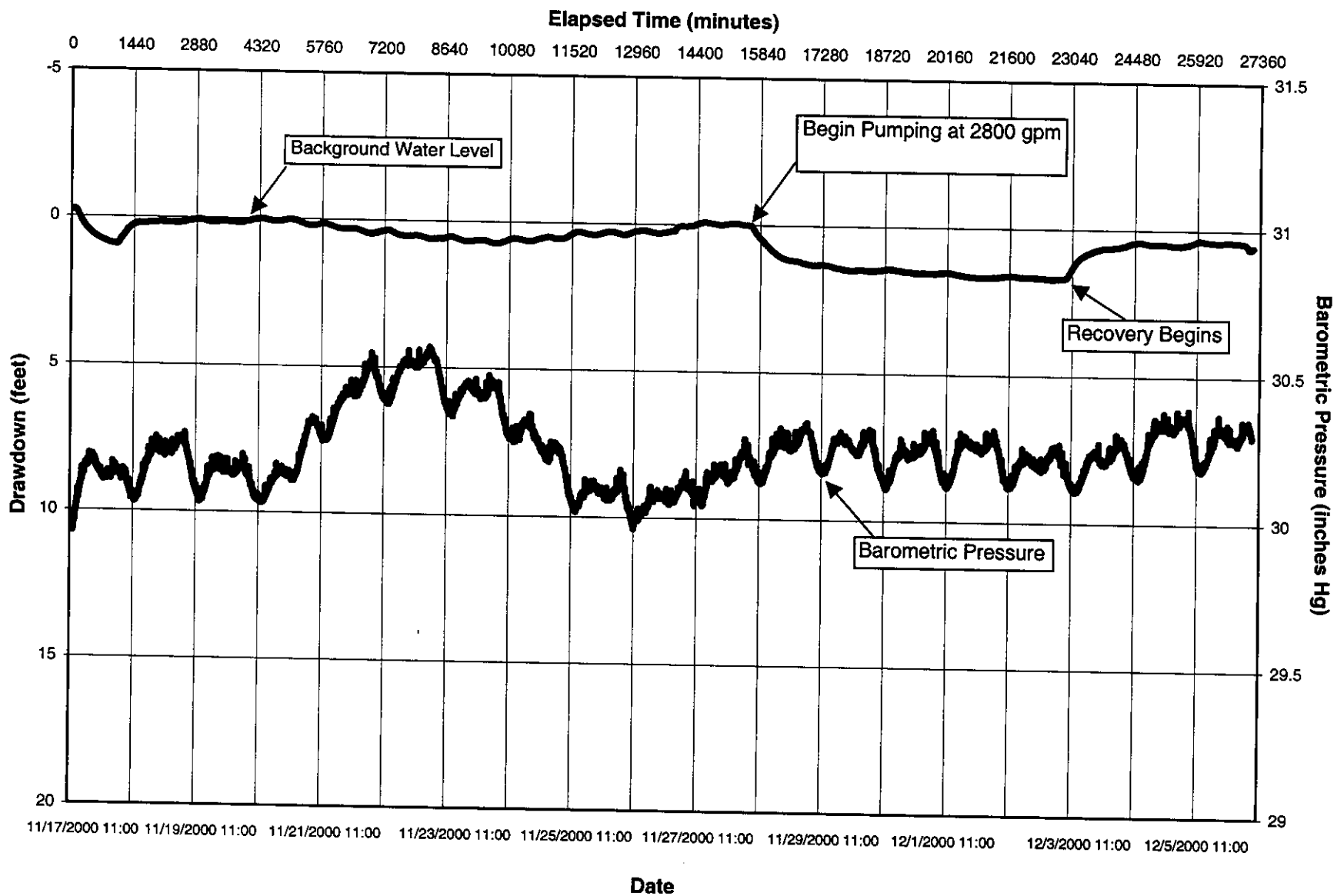

FIGURE H-5

P-5 Pumping Test Water Level Summary Data

**Fort Myers Well P-5 Pumping Test
Well P-2 Water Level Data
November 27- December 5, 2000**



**Fort Myers Well P-5 Pumping Test
Well P-3 Water Level Data
November 27- December 5, 2000**

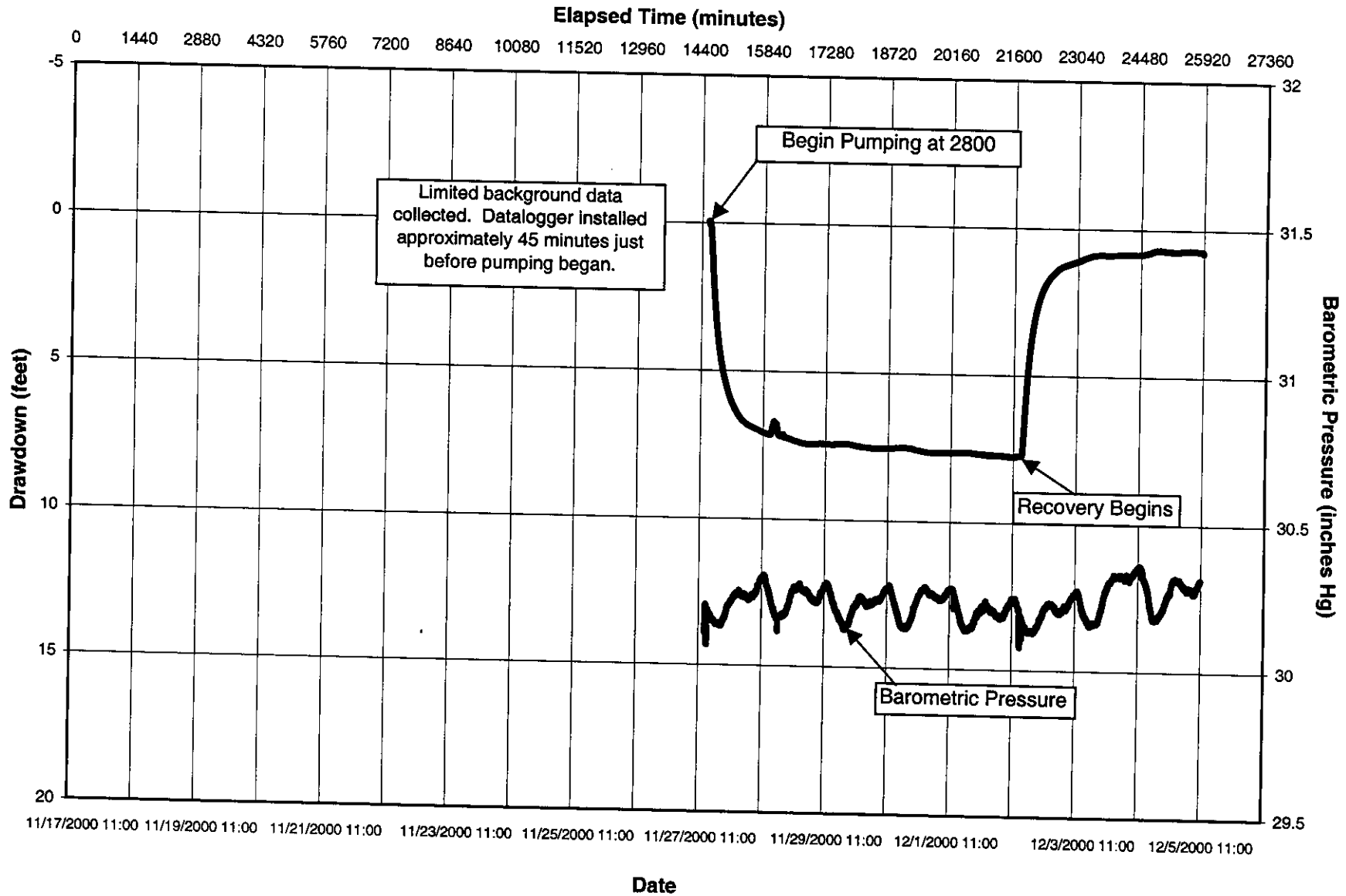

**Fort Myers Well P-5 Pumping Test
Well P-4 Water Level Data
November 27- December 5, 2000**

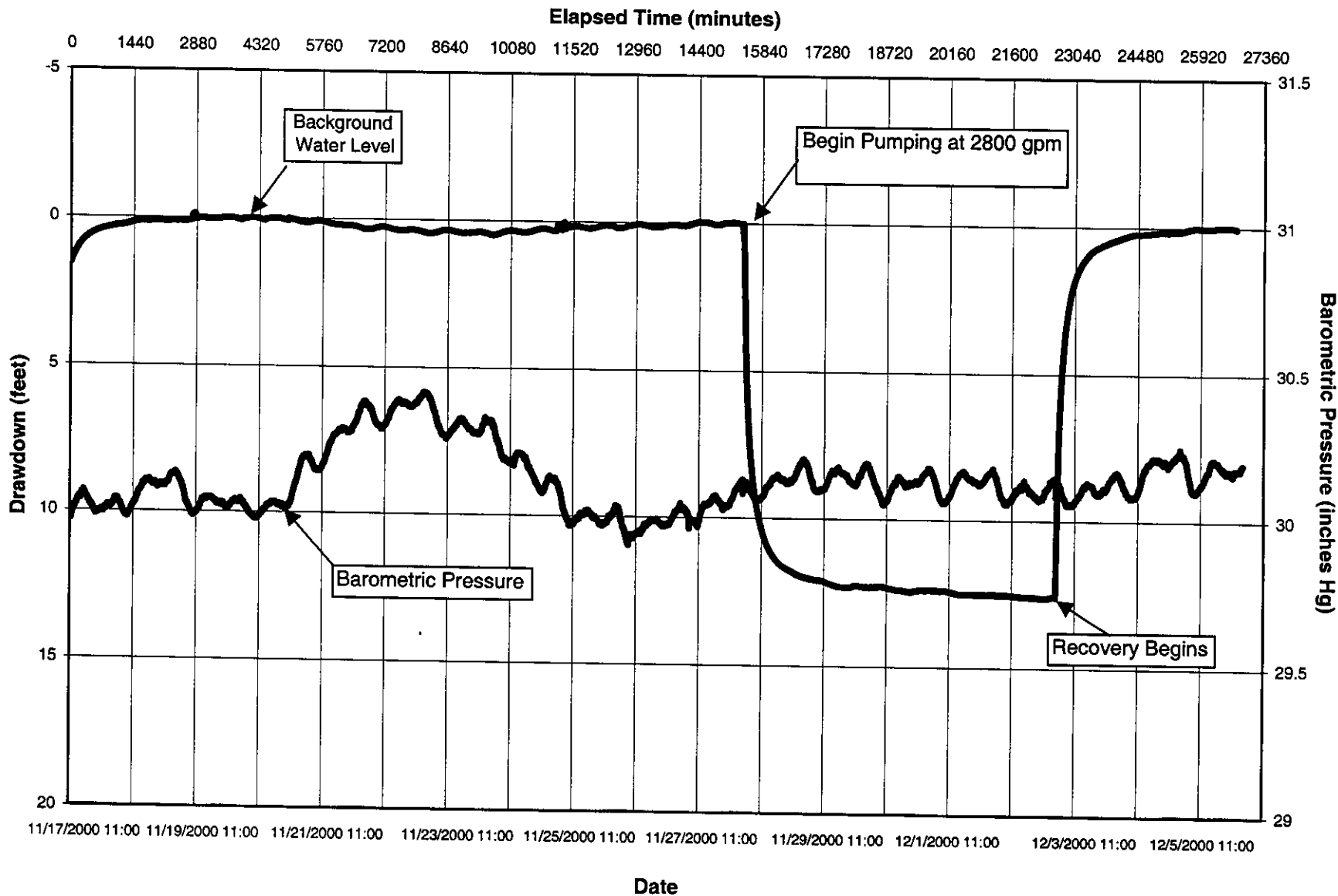

**Fort Myers Well P-5 Pumping Test
Well P-6 Water Level Data
November 27- December 5, 2000**

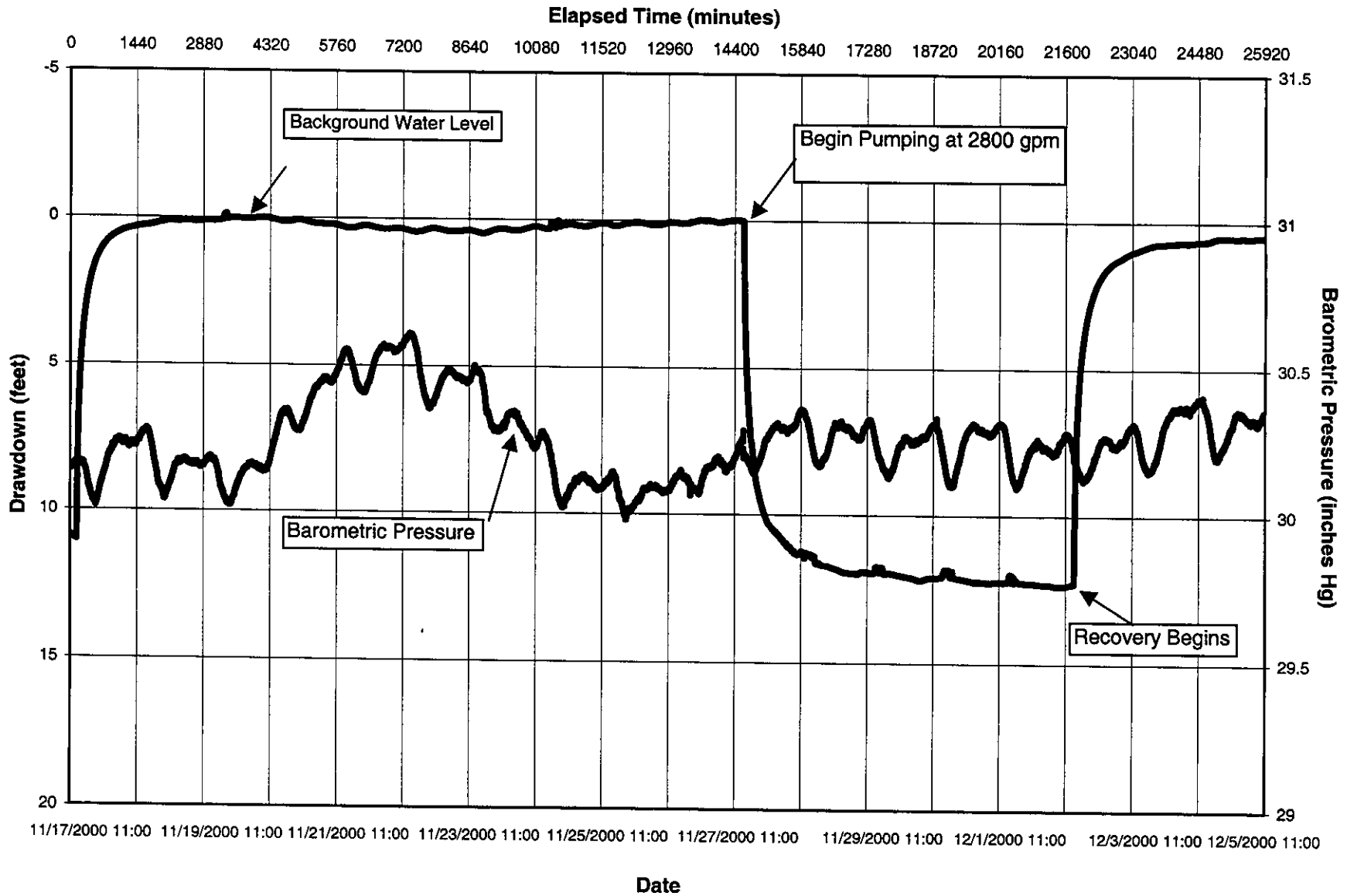

**Fort Myers Well P-5 Pumping Test
Well P-7 Water Level Data
November 27- December 5, 2000**

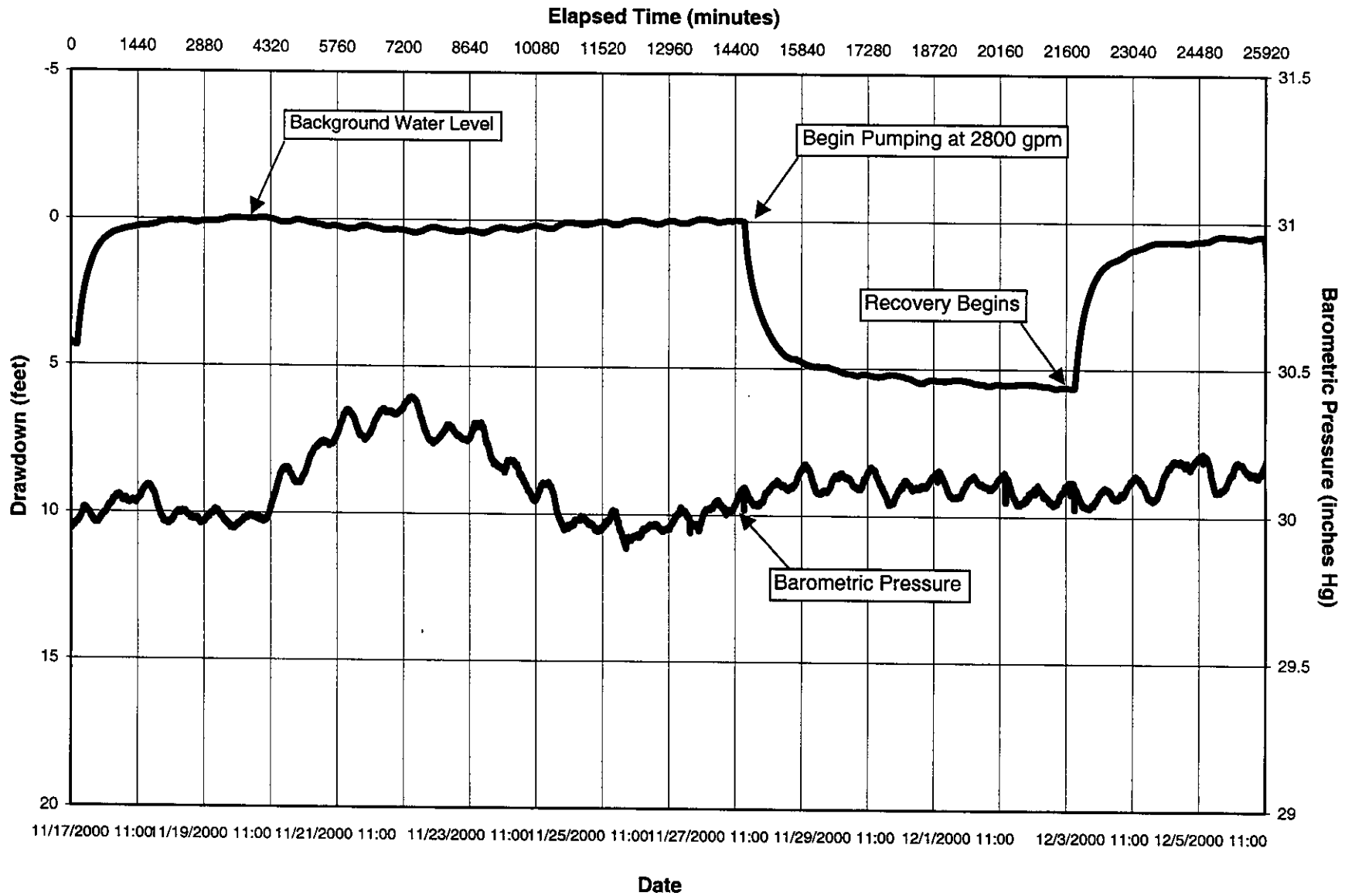

**Fort Myers Well P-6 Pumping Test
Well P-6 Water Level Data
October 16-23, 2000**

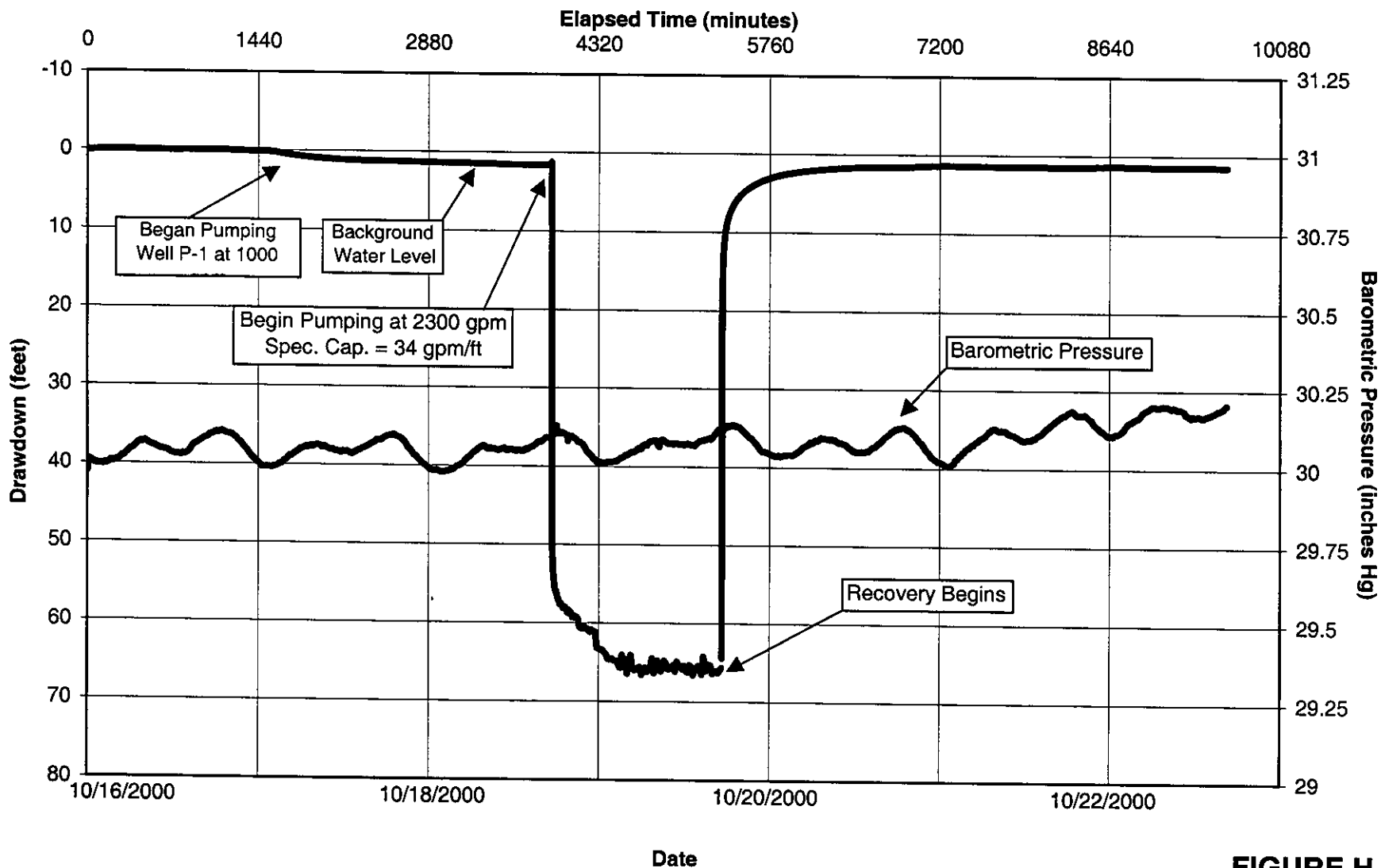

**Fort Myers Well P-6 Pumping Test
Well P-7 Water Level Data
October 16-23, 2000**

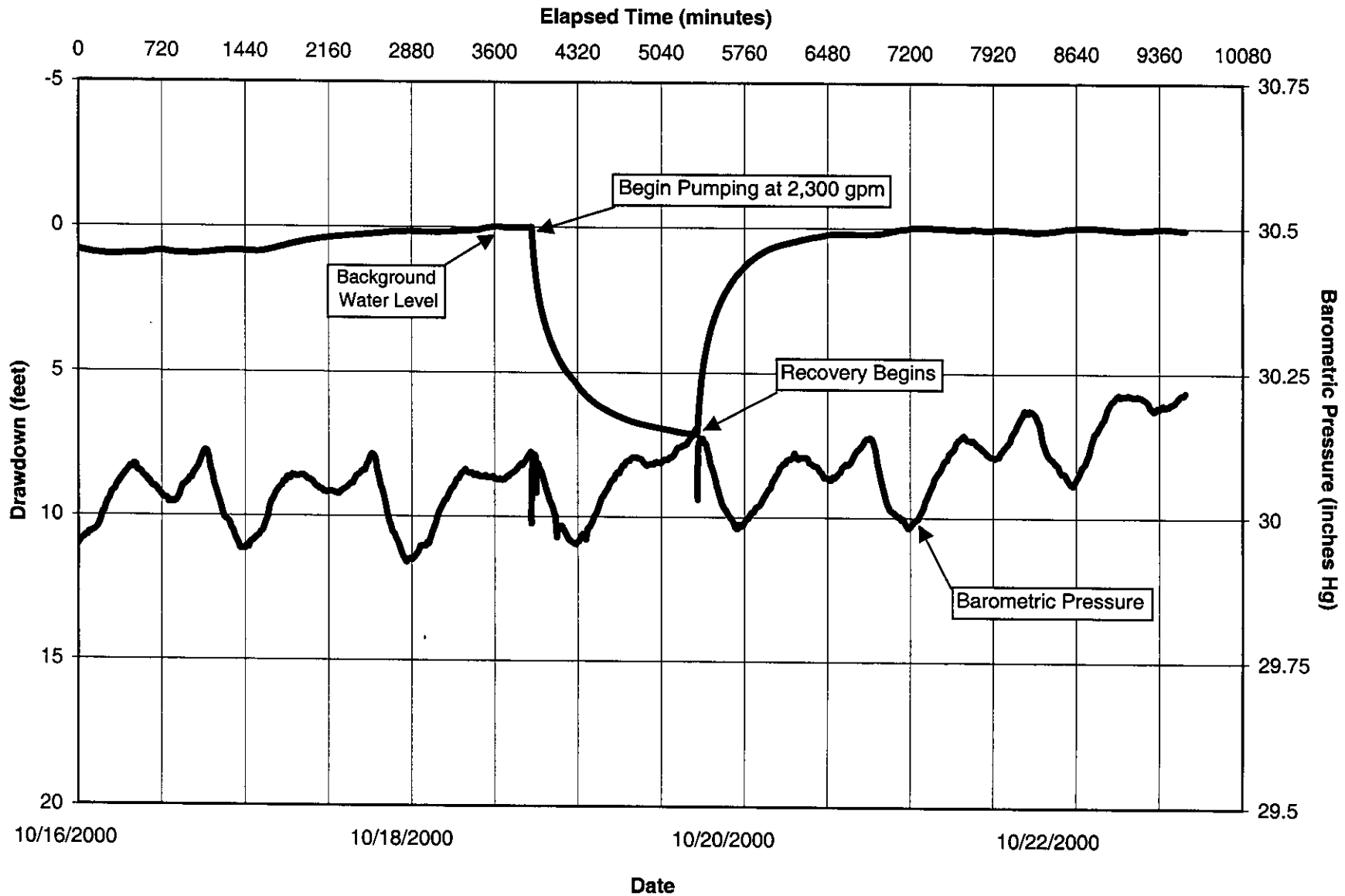

**Fort Myers Well P-7 Pumping Test
Well P-7 Water Level Data
October 26-30, 2000**

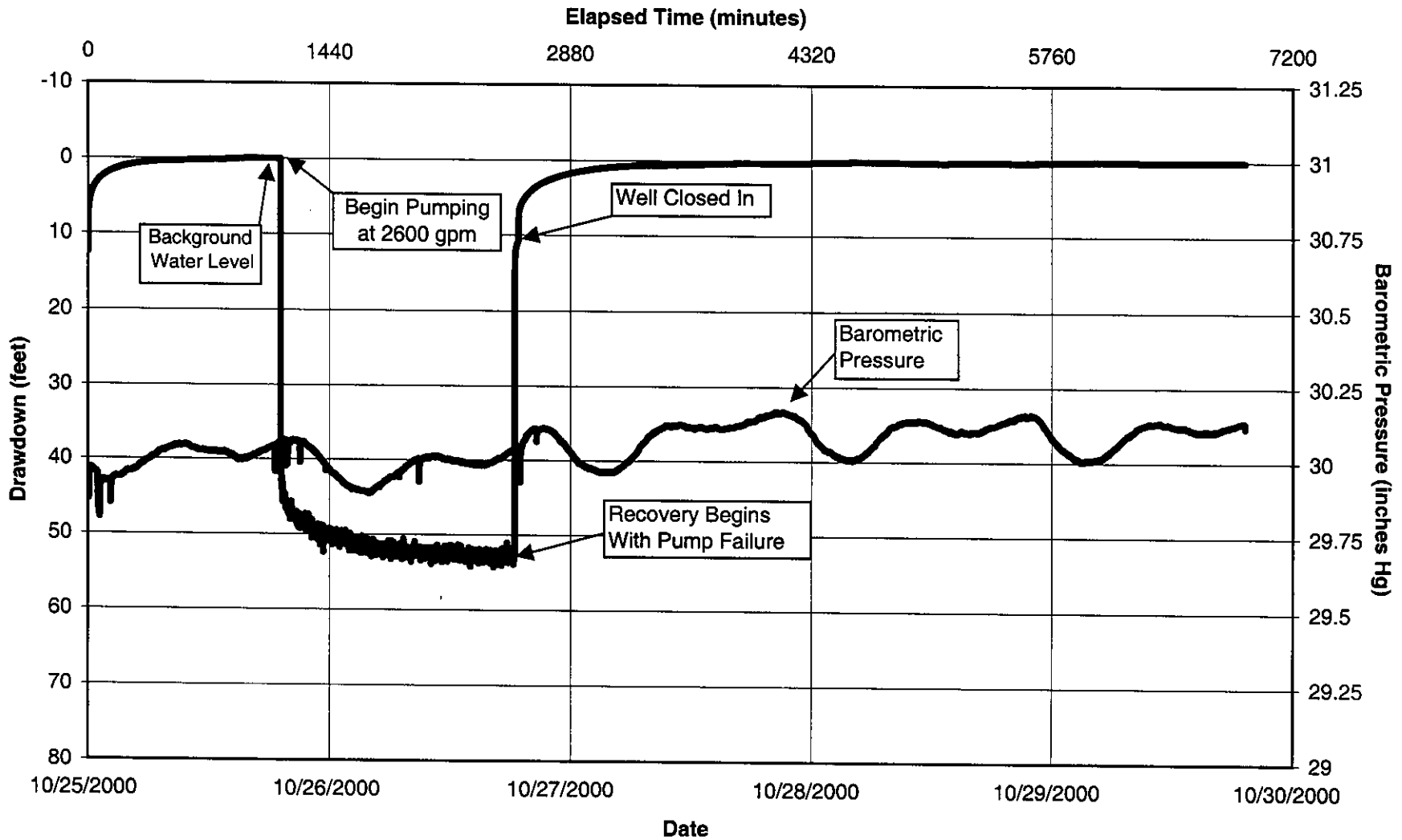

**Fort Myers Well P-7 Pumping Test
Well P-6 Water Level Data
October 26-30, 2000**

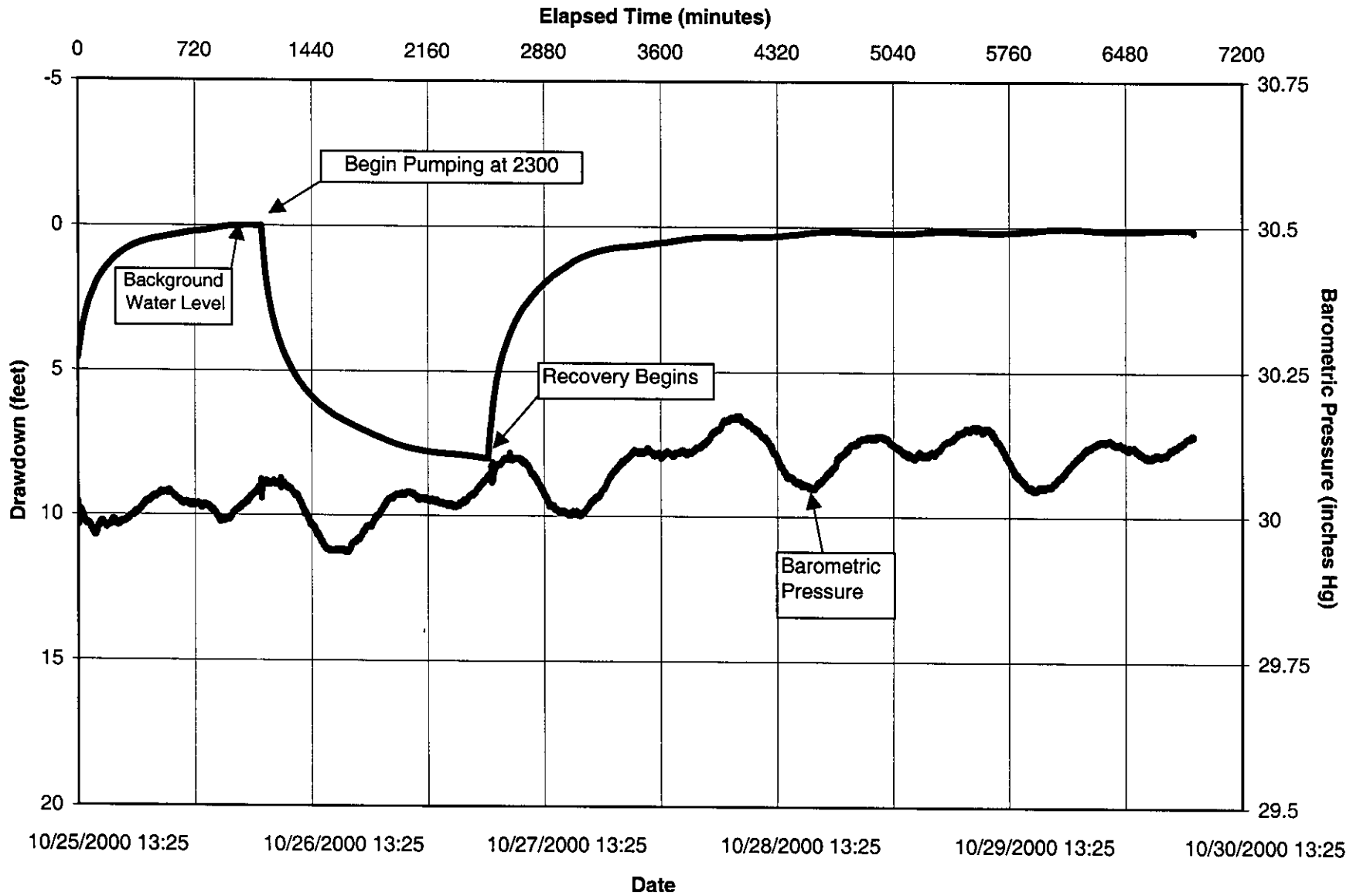

APPENDIX I

Pumping Tests Analyses Plots

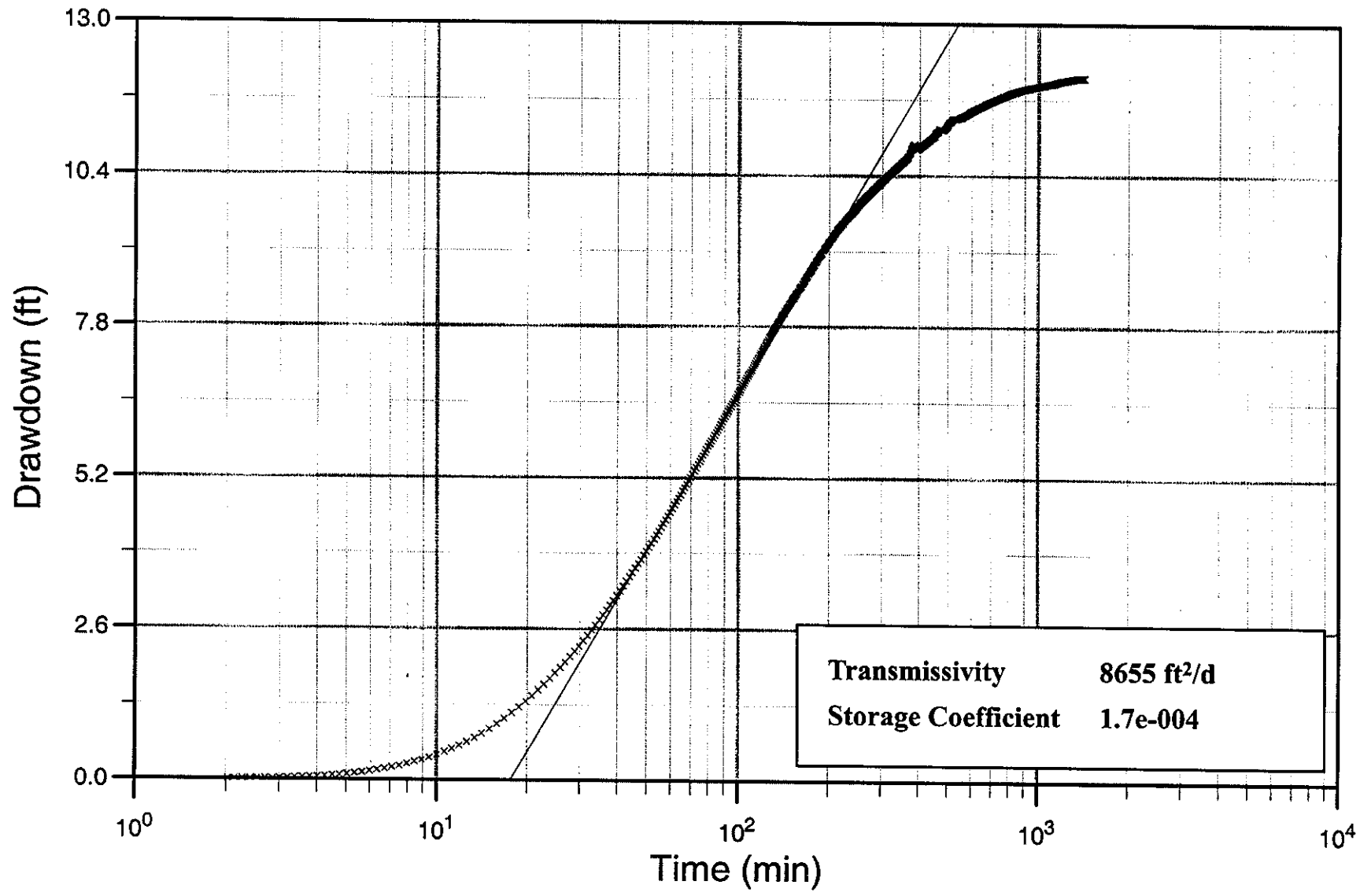

FIGURE I-1
 Well P-3 Aquifer Performance Test
 Well P-4 Observation of Well P-3 Pumping Data – Cooper-Jacob Analysis

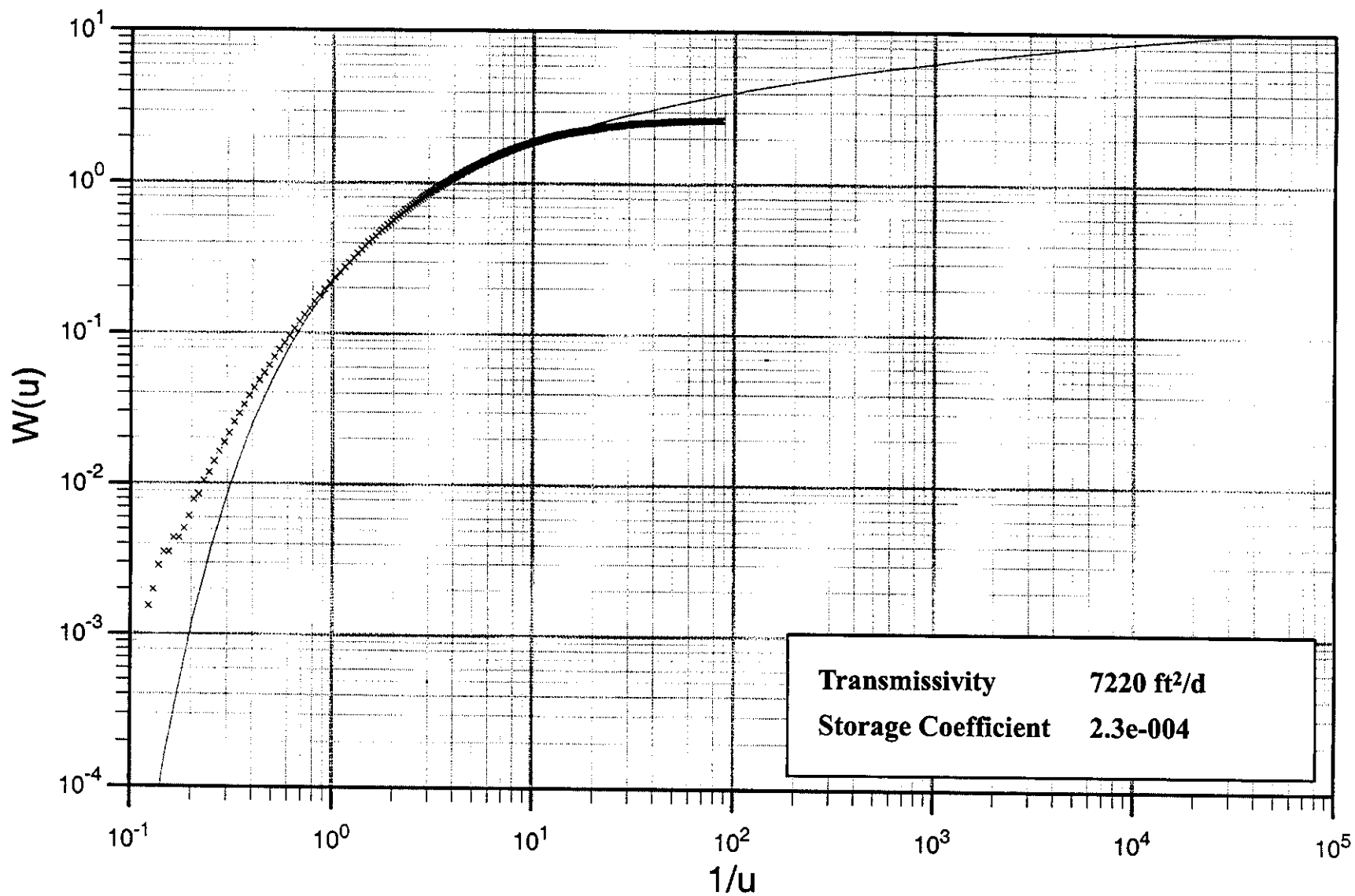

FIGURE I-2

Well P-3 Aquifer Performance Test
 Well P-4 Observation of Well P-3 Pumping Data – This Analysis

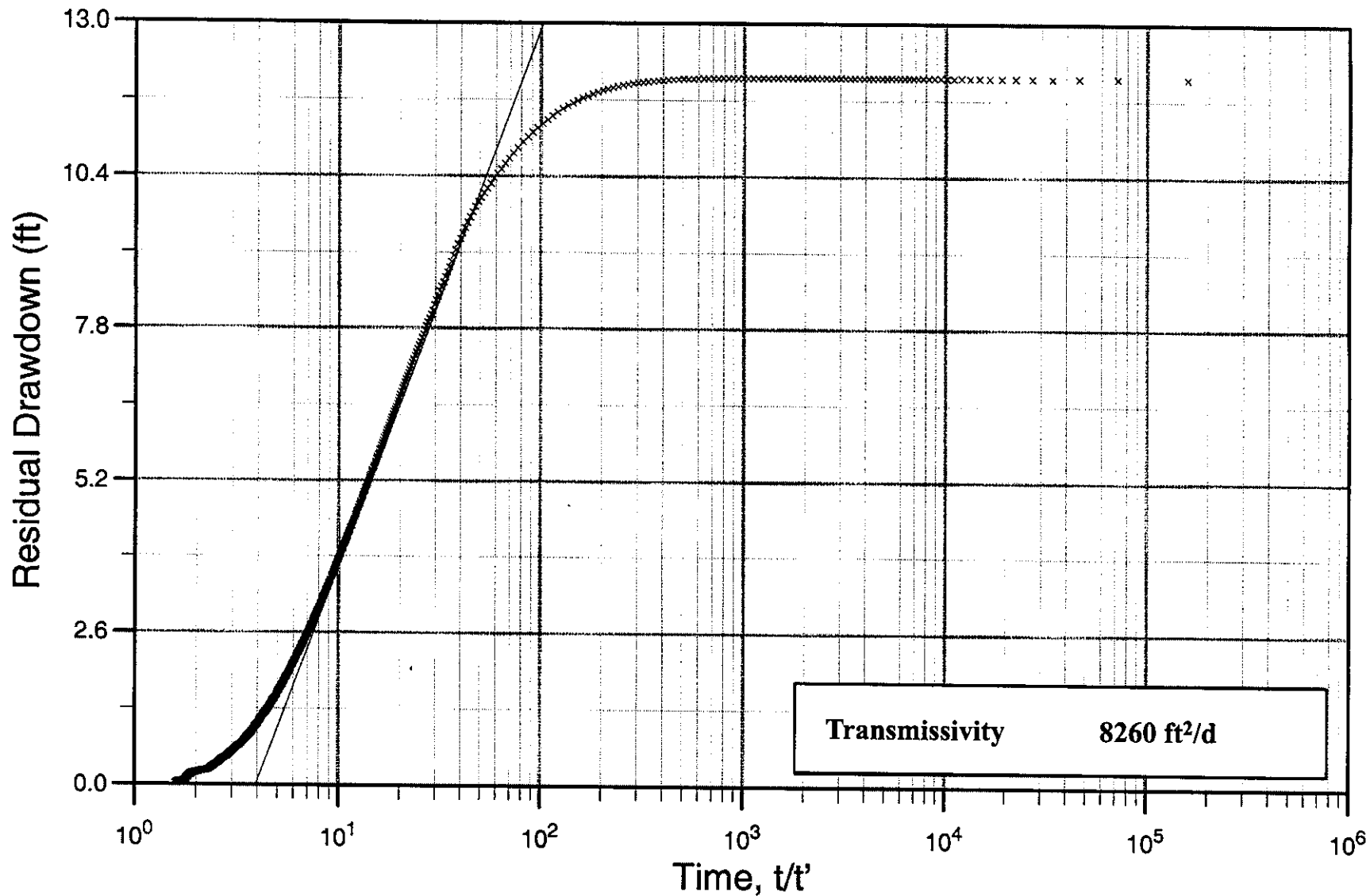

FIGURE I-3

Well P-3 Aquifer Performance Test

Well P-4 Observation of Well P-3 Test Recovery Data – This Recovery Analysis

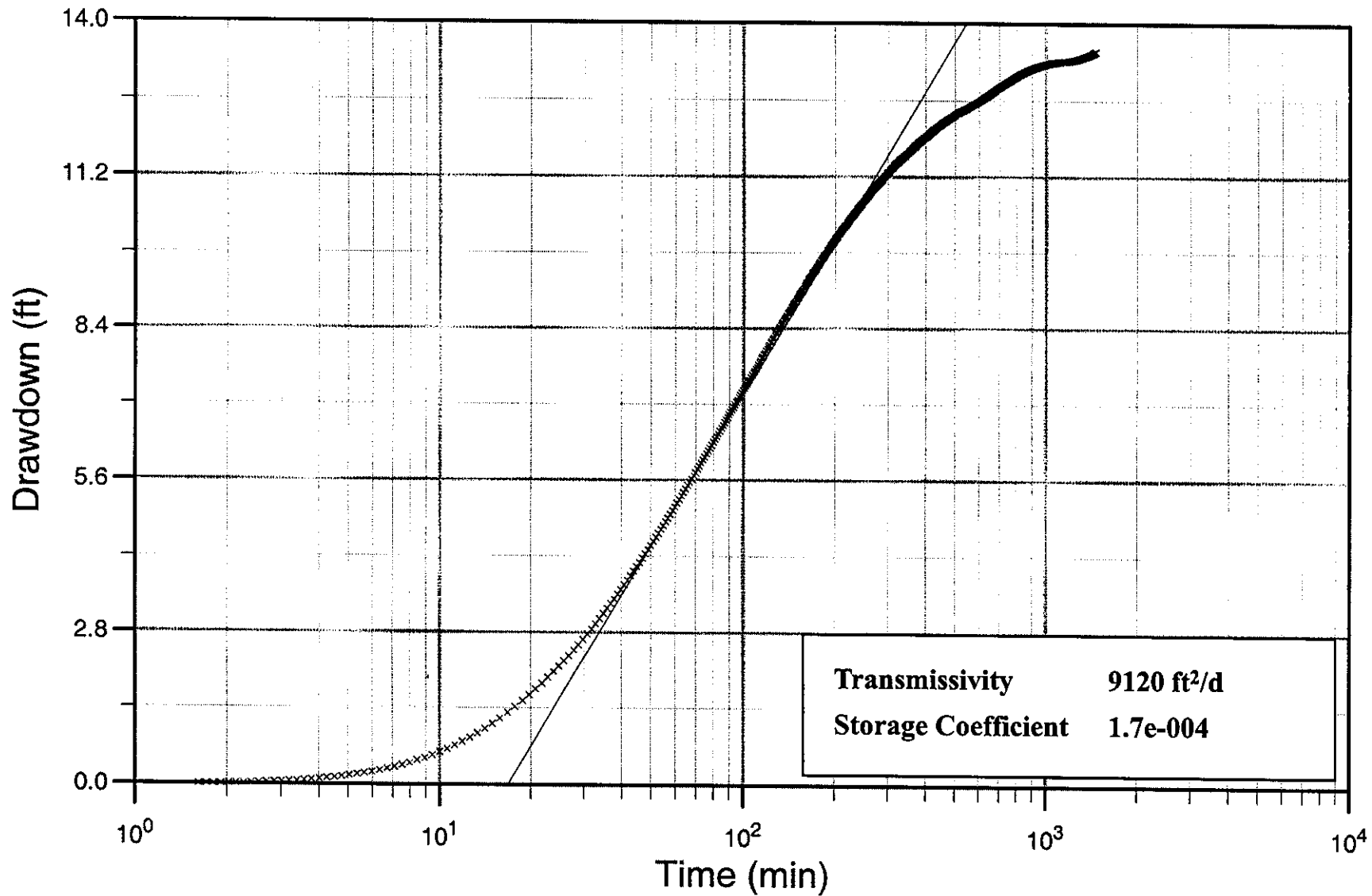

FIGURE I-4

Well P-4 Aquifer Performance Test
 Well P-3 Observation of Well P-4 Pumping Data – Cooper-Jacob Analysis

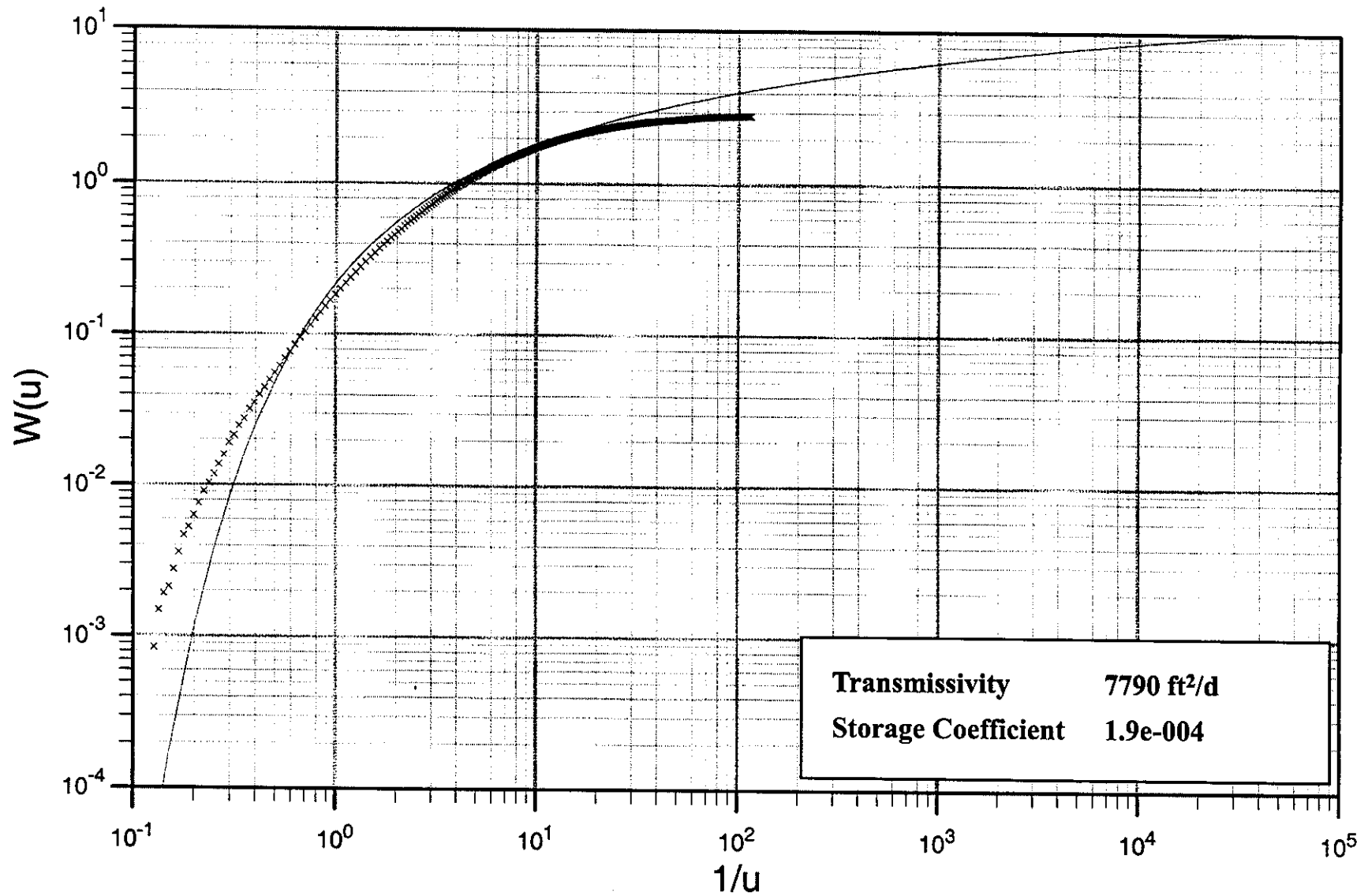

FIGURE I-5
Well P-4 Aquifer Performance Test
Well P-3 Observation of Well P-4 Pumping Data – This Analysis

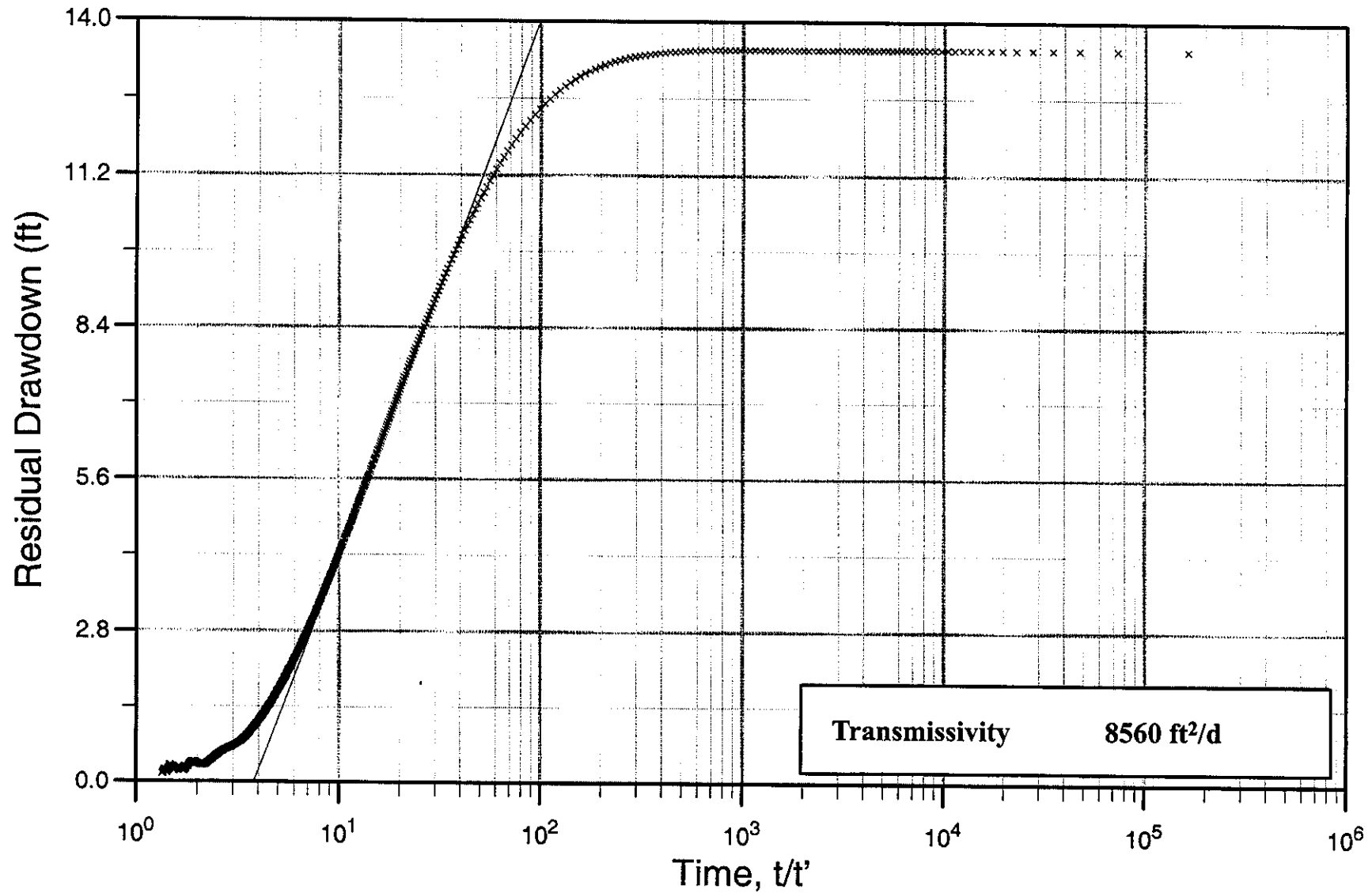

FIGURE I-6

Well P-4 Aquifer Performance Test

Well P-3 Observation of Well P-4 Test Recovery Data – This Recovery Analysis

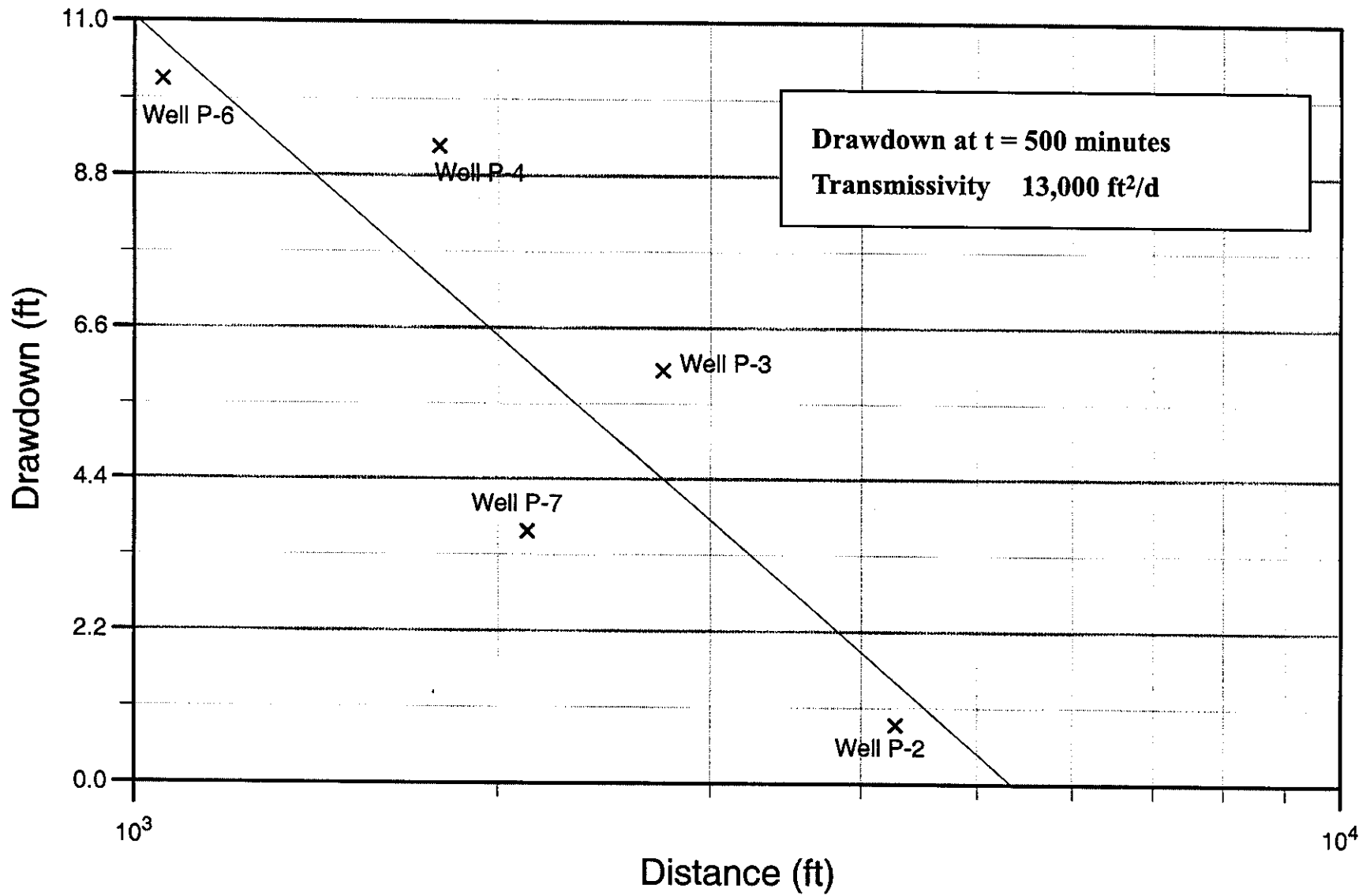

FIGURE I-7

Well P-5 Aquifer Performance Test

Wells P-2, P-3, P-4, P-6 and P-7 Observation of Well P-5 Pumping Data – This Analysis

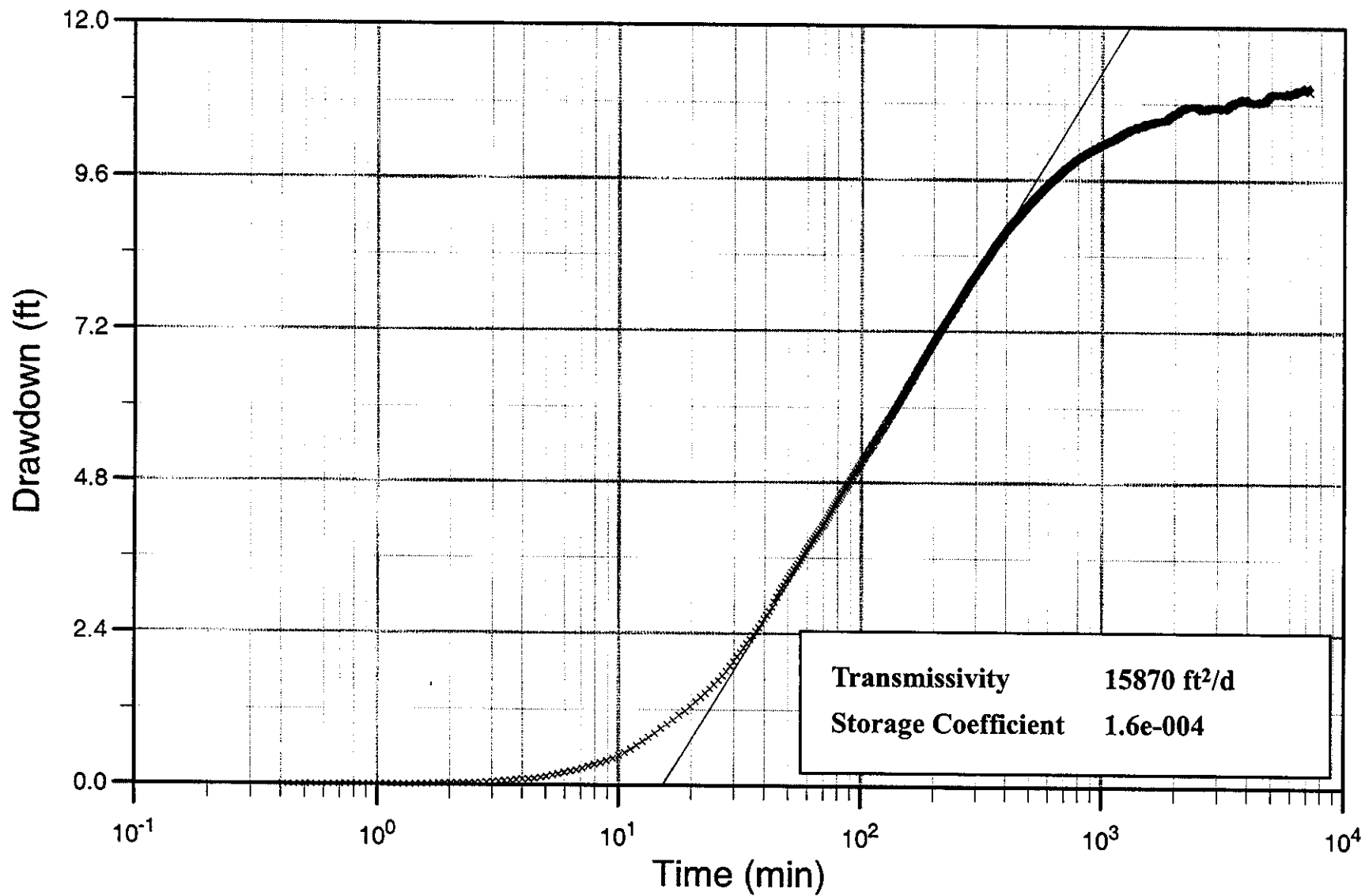

FIGURE I-8

Well P-5 Aquifer Performance Test

Well P-4 Observation of Well P-5 Pumping Data – Cooper-Jacob Analysis

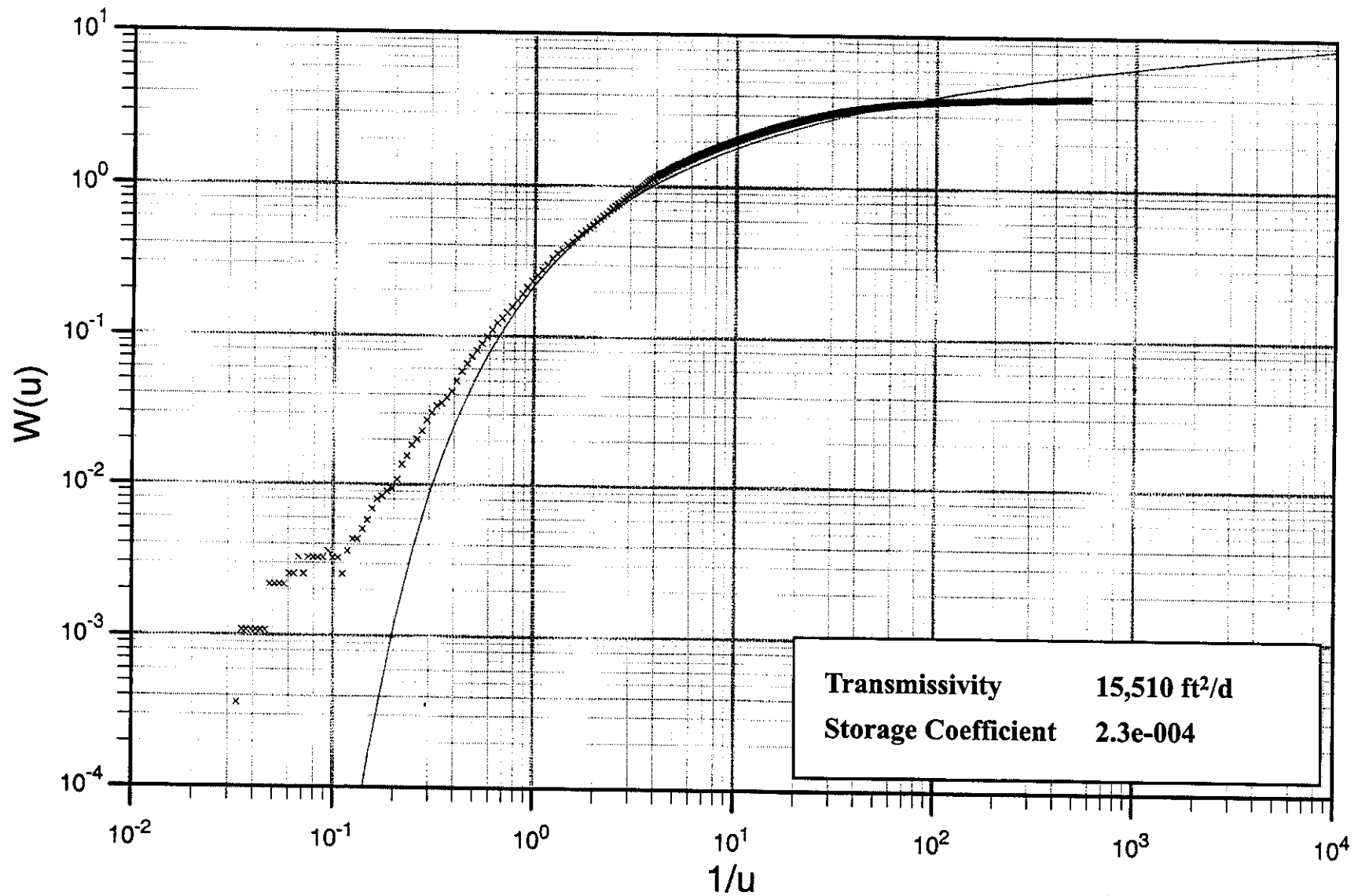

FIGURE I-9
 Well P-5 Aquifer Performance Test
 Well P-4 Observation of Well P-5 Pumping Data – This Analysis

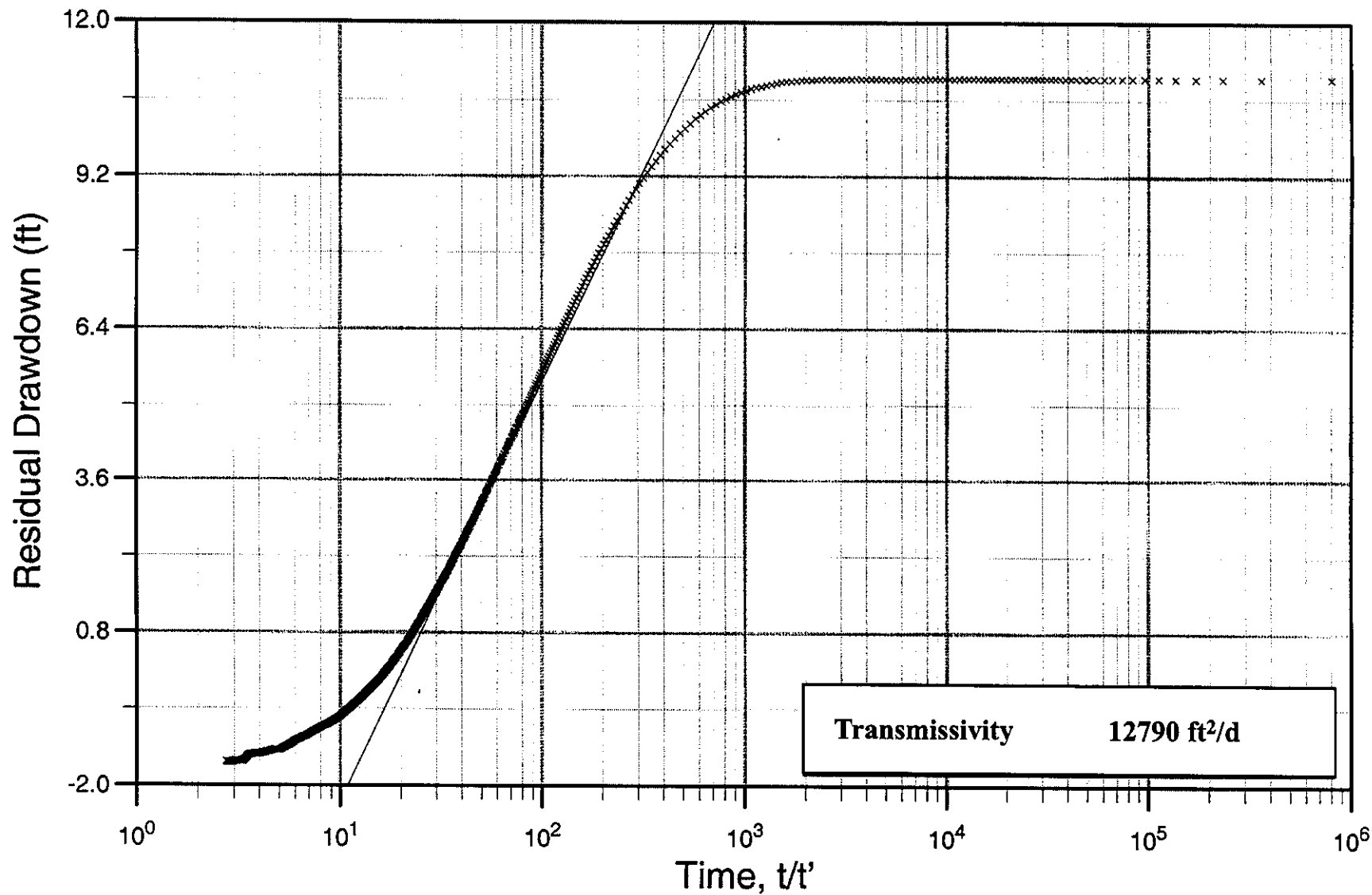

FIGURE I-10

Well P-5 Aquifer Performance Test

Well P-4 Observation of Well P-5 Test Recovery Data – This Recovery Analysis

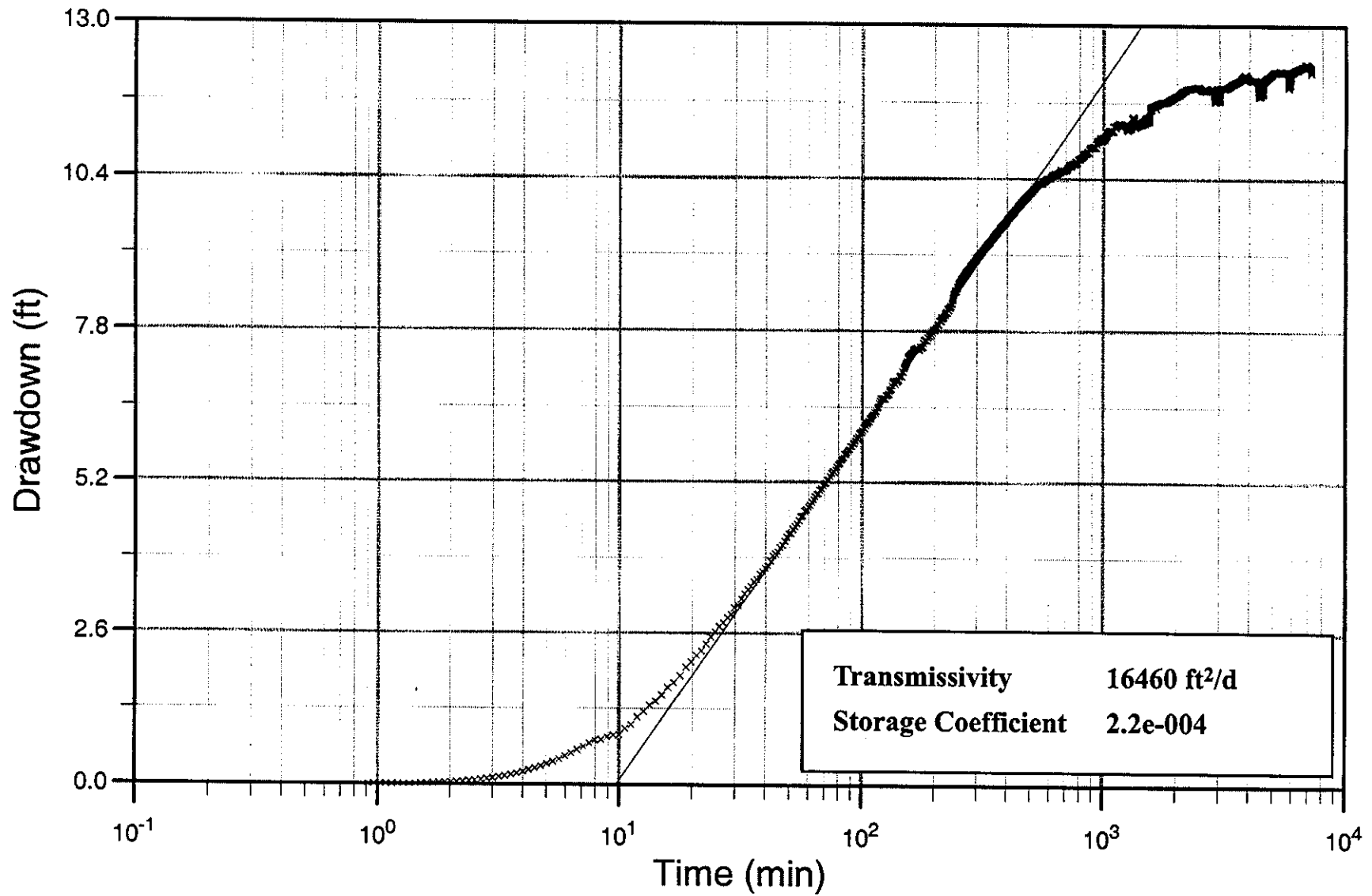

FIGURE I-11
 Well P-5 Aquifer Performance Test
 Well P-6 Observation of Well P-5 Pumping Data – Cooper-Jacob Analysis

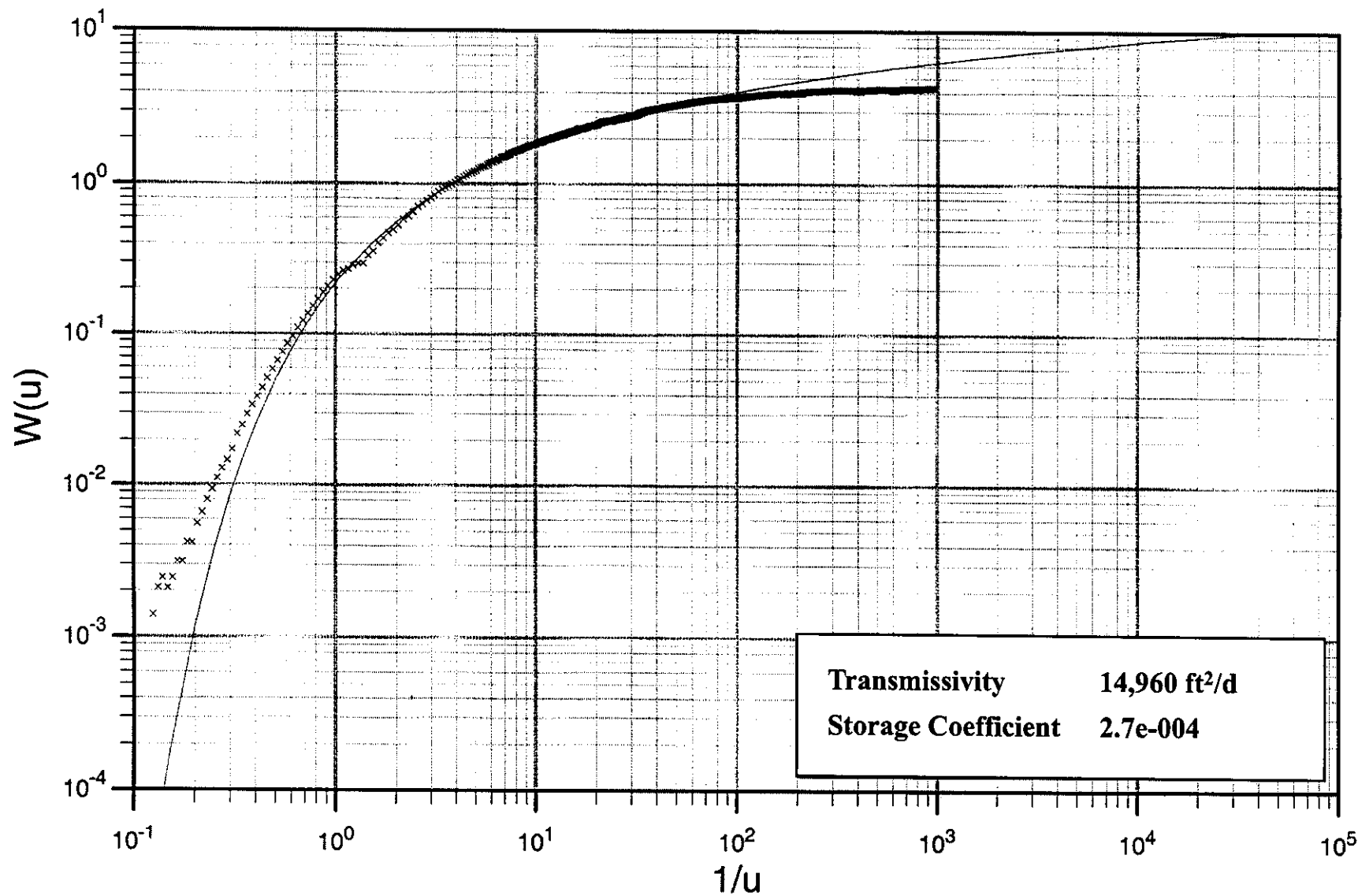

FIGURE I-12

Well P-5 Aquifer Performance Test
 Well P-6 Observation of Well P-5 Pumping Data – This Analysis

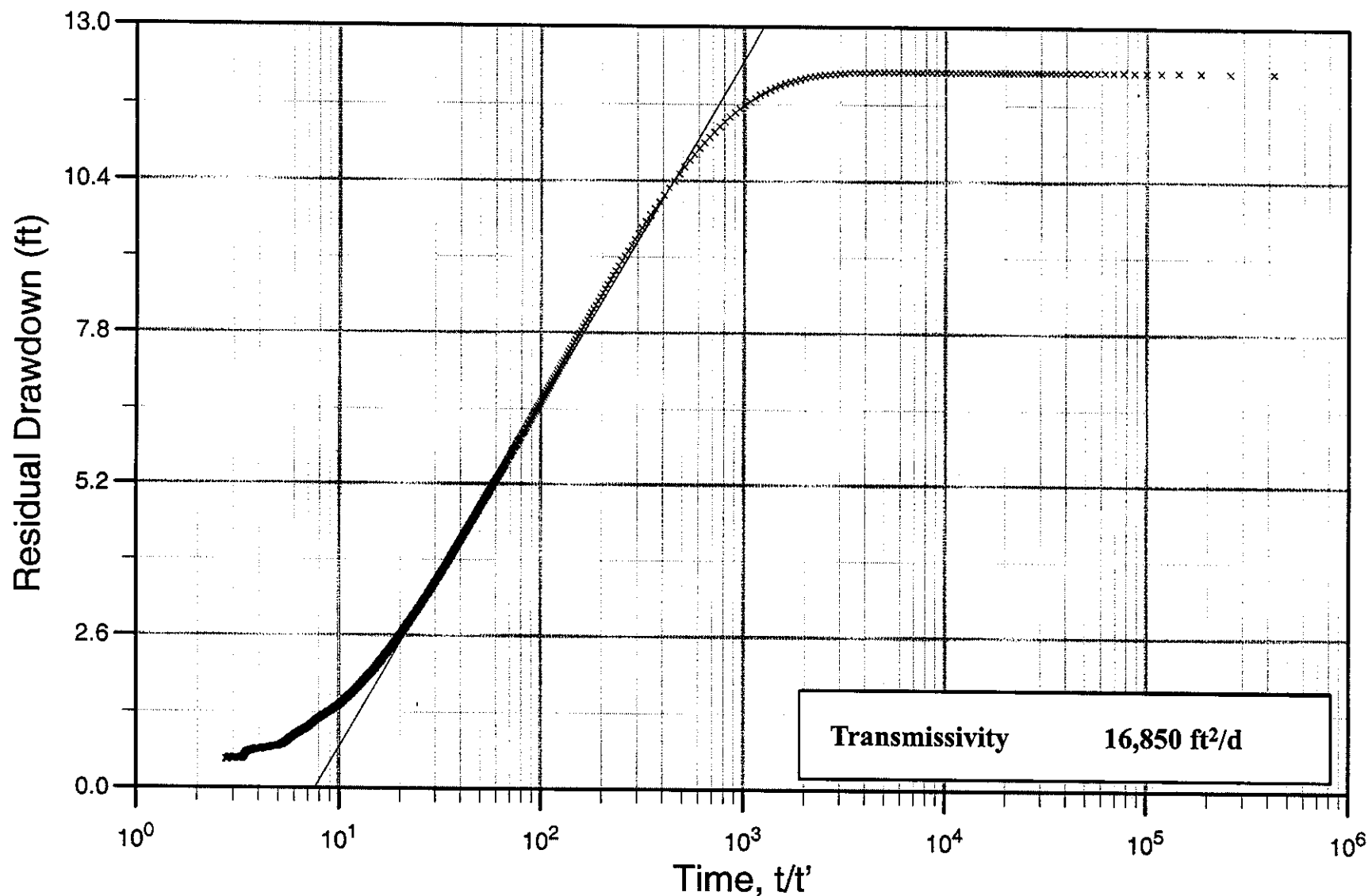

FIGURE I-13

Well P-5 Aquifer Performance Test

Well P-6 Observation of Well P-5 Test Recovery Data – This Recovery Analysis

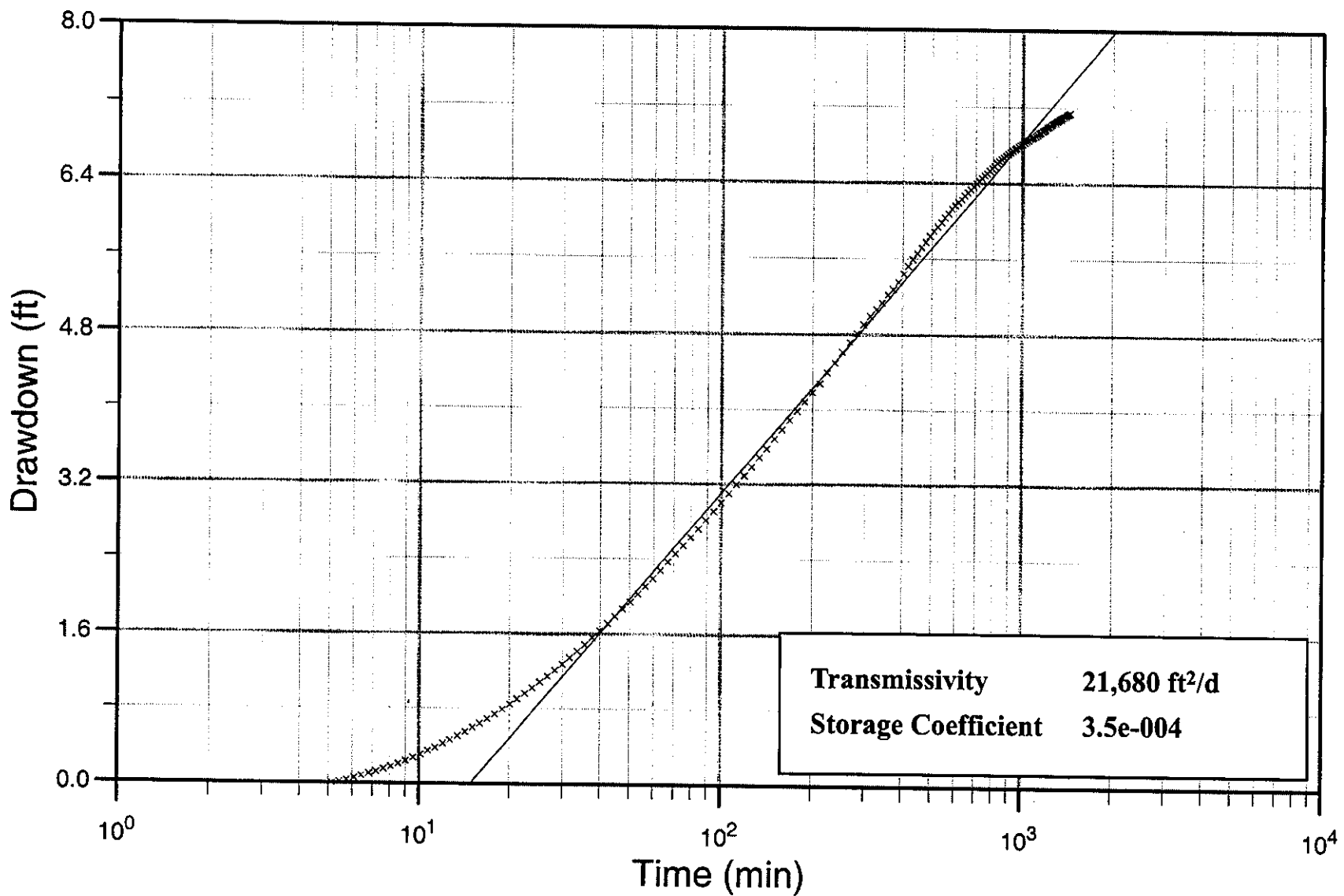

FIGURE I-14

Well P-6 Aquifer Performance Test

Well P-7 Observation of Well P-6 Pumping Data – Cooper-Jacob Analysis

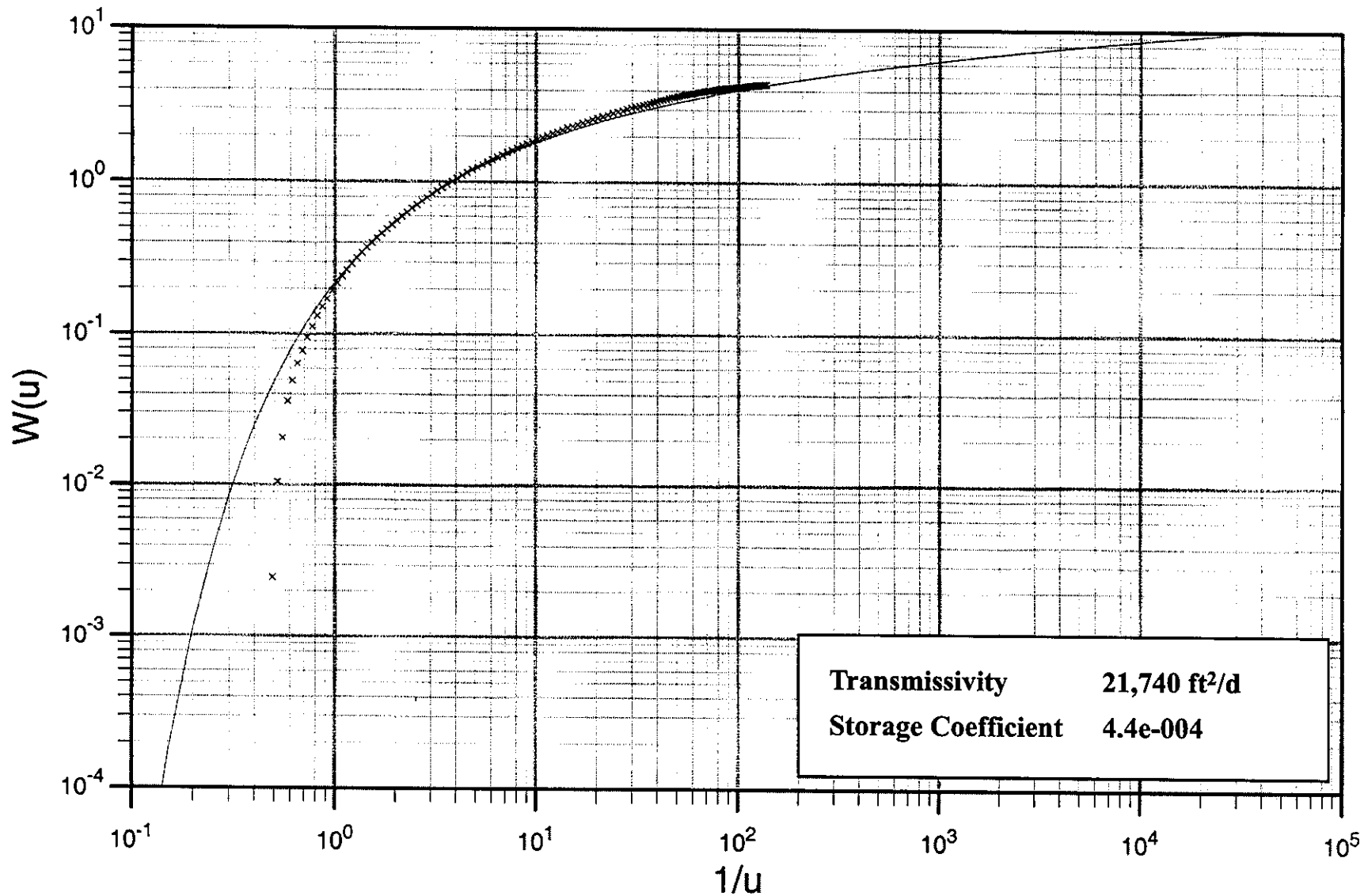

FIGURE I-15
 Well P-6 Aquifer Performance Test
 Well P-7 Observation of Well P-6 Pumping Data – This Analysis

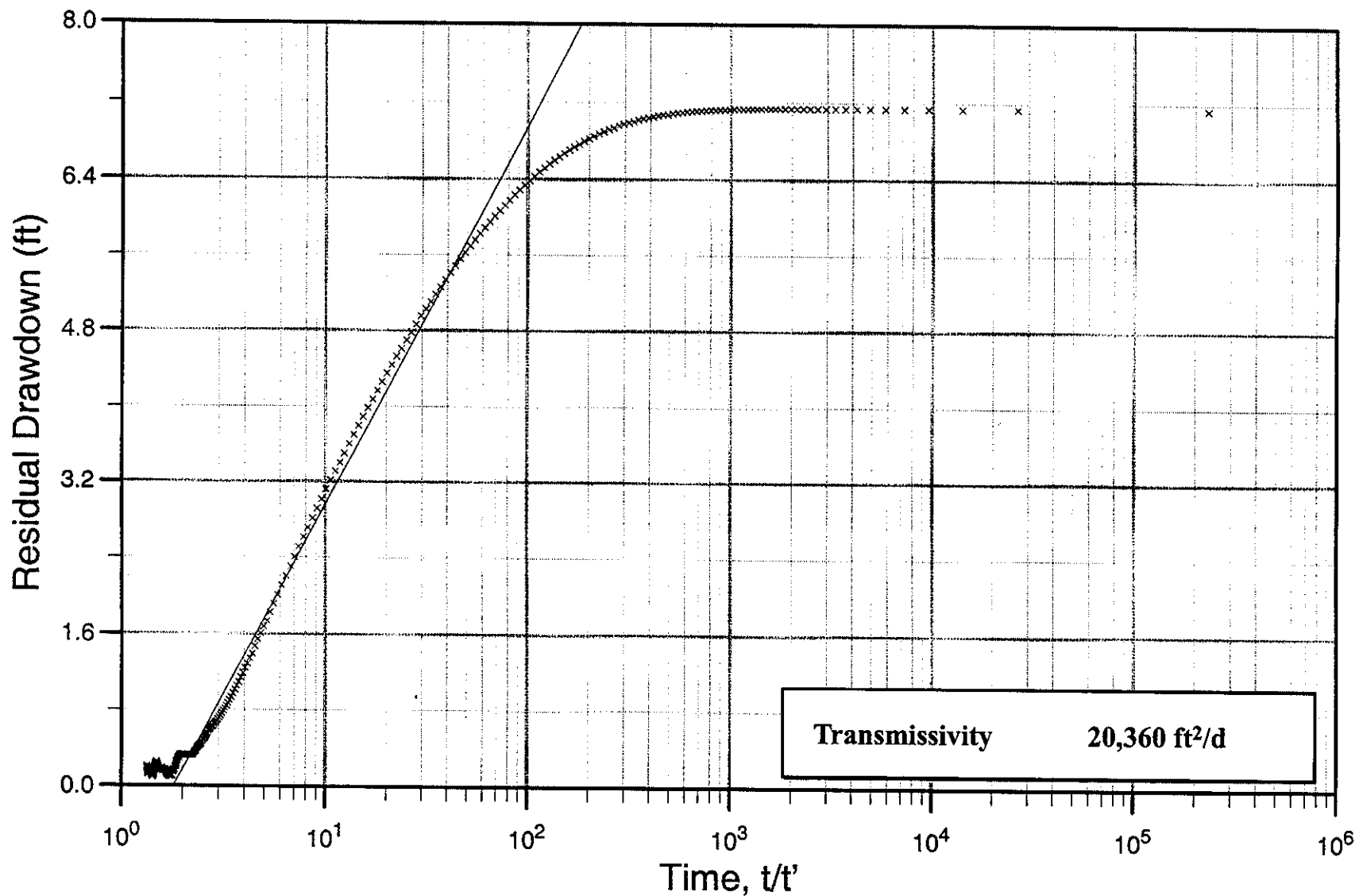

FIGURE I-16

Well P-6 Aquifer Performance Test

Well P-7 Observation of Well P-6 Test Recovery Data – This Recovery Analysis

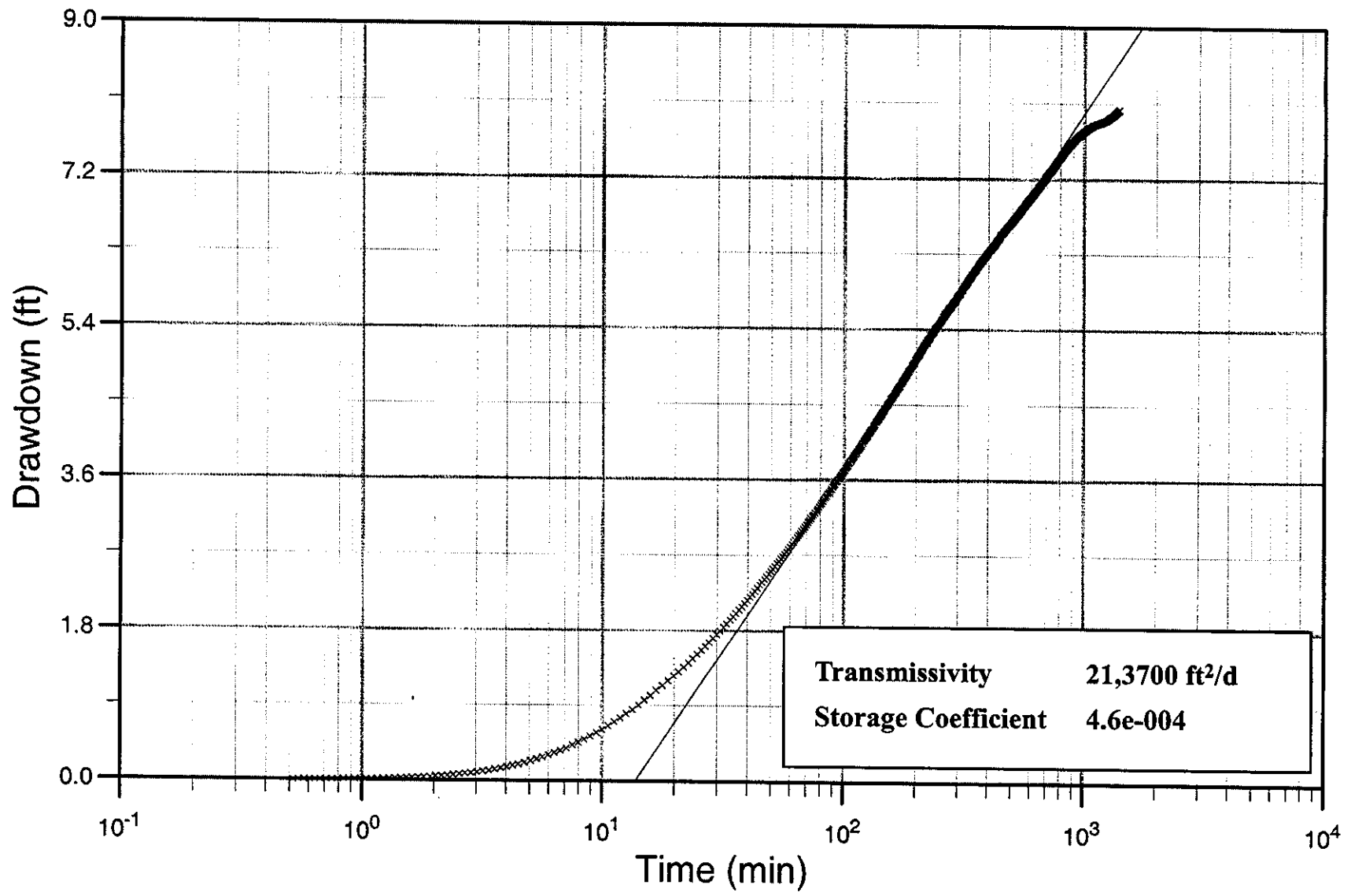

FIGURE I-17

Well P-7 Aquifer Performance Test

Well P-6 Observation of Well P-7 Pumping Data – Cooper-Jacob Analysis

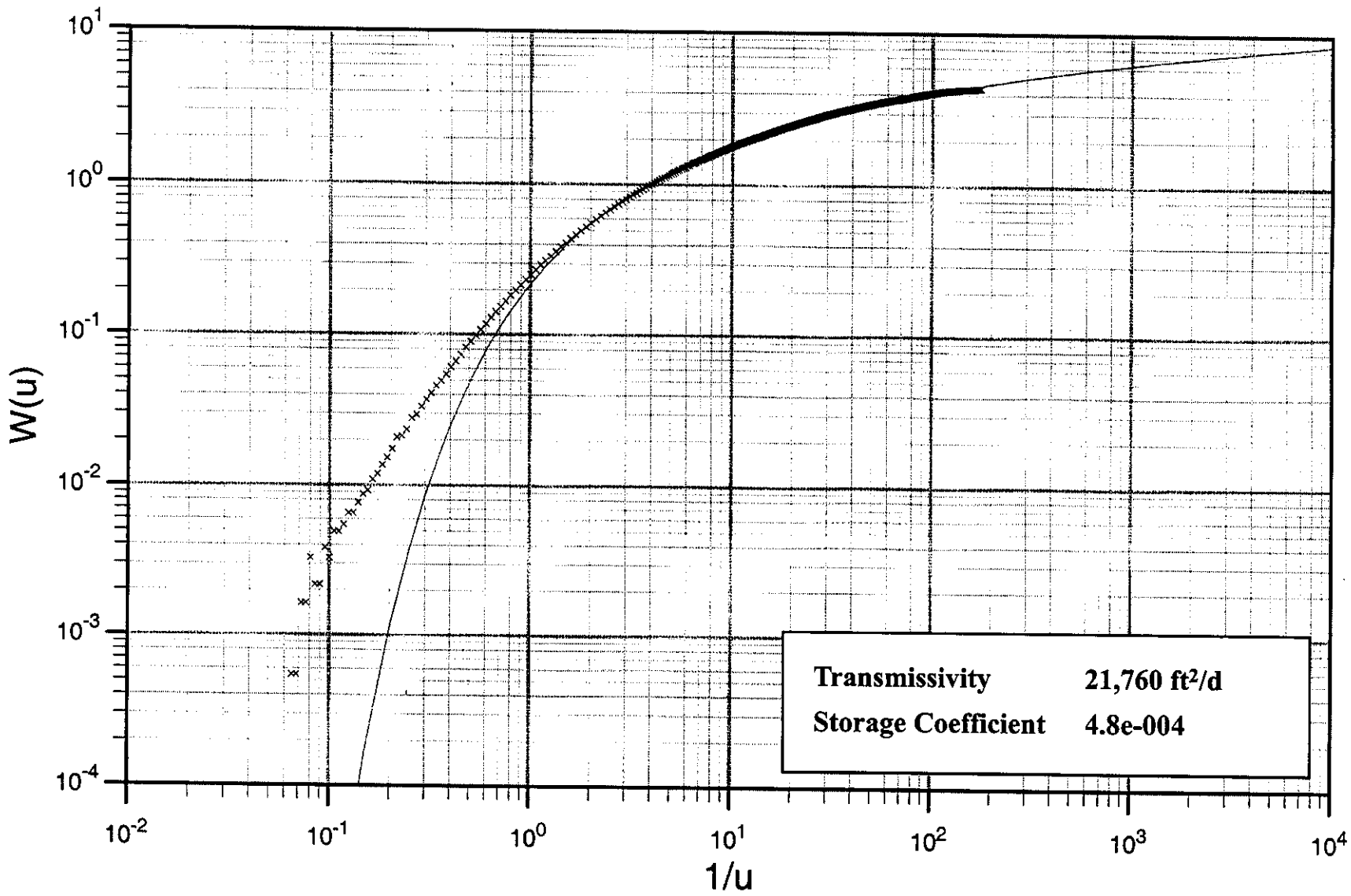

FIGURE I-18

Well P-7 Aquifer Performance Test
Well P-6 Observation of Well P-7 Pumping Data – This Analysis

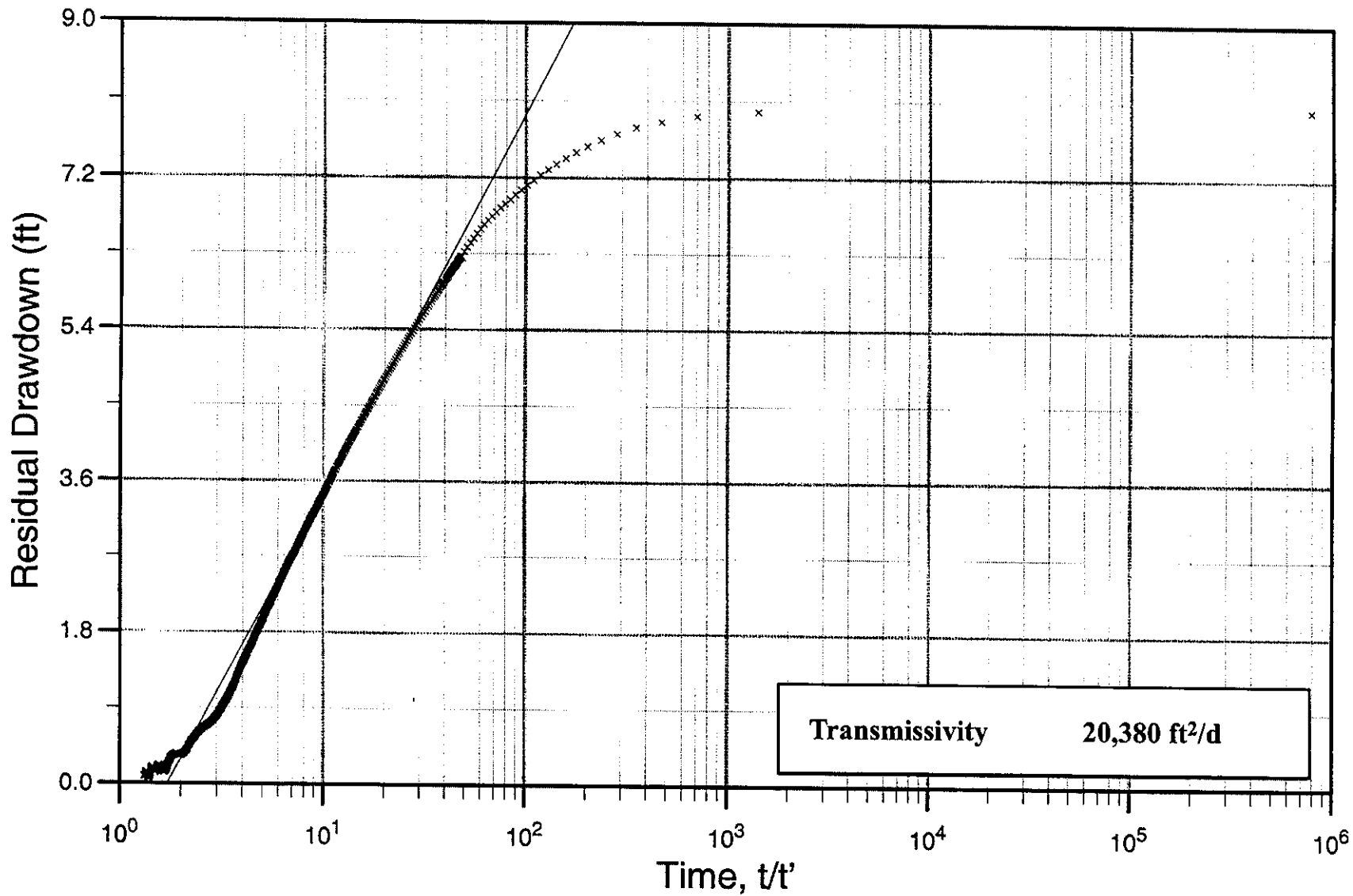

FIGURE I-19

Well P-7 Aquifer Performance Test

Well P-6 Observation of Well P-7 Test Recovery Data – This Recovery Analysis

APPENDIX J

Ambient Water Quality Results

TABLE J-1

Final Water Quality Results Summary

City of Fort Myers WTP – Well Completion Report (P-3 through P-7)

Parameter	MCL ¹	Well P-1	Well P-2	Well P-3	Well P-4	Well P-5	Well P-6	Well P-7
Total Dissolved Solids (ppm)	500	1620	2140	2200	1900	2000	2100	2200
Chloride (ppm)	250	680	950	910	920	880	780	940
Sodium (ppm)	160	350	470	480	400	410	440	430
Conductance (umhos/cm)	NA	2790	3990	3770	3180	3530	3500	3640
Turbidity (NTU)	NA	NA	0.52	NA	NA	NA	NA	NA
Fluoride (ppm)	4	1.72	1.29	1.6	1.6	1.6	1.6	1.6
Color (PCU)	15	5	2.5	<5	<5	<5	<5	<5
pH	6.5-8.5	7.13	7.44	7.45	7.34	7.31	7.55	7.4
Iron (ppm)	0.3	0.041	<0.04	<0.04	<0.04	<0.04	<0.04	<0.40
Sulfate(ppm)	250	366	315	350	380	320	300	370
Arsenic (ppm)	0.050	<0.0022	<0.003	<0.005	<0.005	<0.005	<0.005	<0.005
Lead (ppm)	0.015	<0.001	<0.002	<0.001	<0.002	<0.002	<0.002	0.0012
Gross Alpha (pCi/L)	15	8.4 +/- 4.6	<3.0 +/- 0.72	12.7 +/- 2.9	9.4+/-3.4	9.2 +/- 3.7	6.8 +/- 2.8	6.0 +/- 3.8
Radium 226 (pCi/L)		2.9 +/- 0.4	7.02 +/- 1.19	9.9 +/- 0.5	5.5 +/- 0.4	NA	5.8 +/- 0.3	4.2 +/- 0.3
Radium 228 (pCi/L)	5	<0.7 +/- 0.4	0.14 +/- 0.77	2.0 +/- 0.06	1.0 +/- 0.6	NA	0.9 +/- 0.6	1.0 +/- 0.7

Notes:

1. Maximum Contaminant Level (MCL) per Rules 62-550.310, FAC.

2. Concentrations expressed in milligrams/liter (mg/L or ppm) unless otherwise indicated.

3. Abbreviations:

pCi/L: Picocuries/liter

NTU: Nephelometric Turbidity Unit

ppm: parts per million

umhos/cm: micro mhos per centimeter

PCU: Platinum Cobal Units

NA: Not Available

4. The MCL for Radium 226 and Radium 228 combined is 5pCi/L

APPENDIX J.1

Well P-3 Ambient Water Quality Results

MR. RICHARD MOULTON
CITY OF FORT MYERS
2751 JACKSONVILLE ST
FORT MYERS, FL 33916



ANALYTICAL REPORT

Page 1

Submission Number: 11000170 Client's P.O. Number:
Date Received: 11/07/00 Project Number:
Date Reported: 11/29/00 Project Name:
Elab Report Name: Finalnew->Final2.RP1

Lab Sample Number: 0011170 1 Date Sampled: 11/06/00
Client Sample Number: Sample Matrix: DRINKING WATER
Sample Description: DEEP WELL P3

Method	Analyte	Result	Q	Units	Limit	Reporting Analyst	Date Analyzed	Prepared
<u>PRIORITY POLLUTANT B/N/A EXTRACTABLES</u>								
625	ACENAPHTHENE	5.0	U	ug/L	5.0	VG	11/15/00	11/07/00
625	ACENAPHTHYLENE	5.0	U	ug/L	5.0	VG	11/15/00	11/07/00
625	ANTHRACENE	5.0	U	ug/L	5.0	VG	11/15/00	11/07/00
625	BENZIDINE	25	U	ug/L	25	VG	11/15/00	11/07/00
625	BENZ(A)ANTHRACENE	5.0	U	ug/L	5.0	VG	11/15/00	11/07/00
625	BENZO(B)FLUORANTHENE	5.0	U	ug/L	5.0	VG	11/15/00	11/07/00
625	BENZO(K)FLUORANTHENE	5.0	U	ug/L	5.0	VG	11/15/00	11/07/00
625	BENZO(G,H,I)PERYLENE	5.0	U	ug/L	5.0	VG	11/15/00	11/07/00
625	BENZO(A)PYRENE	5.0	U	ug/L	5.0	VG	11/15/00	11/07/00
625	BIS(2-CHLOROETHOXY) METHANE	5.0	U	ug/L	5.0	VG	11/15/00	11/07/00
625	BIS(2-CHLOROETHYL) ETHER	5.0	U	ug/L	5.0	VG	11/15/00	11/07/00
625	BIS(2-CHLOROISOPROPYL) ETHER	5.0	U	ug/L	5.0	VG	11/15/00	11/07/00
625	BIS(2-ETHYLHEXYL) PHTHALATE	5.0	U	ug/L	5.0	VG	11/15/00	11/07/00
625	4-BROMOPHENYL PHENYL ETHER	5.0	U	ug/L	5.0	VG	11/15/00	11/07/00
625	BUTYL BENZYL PHTHALATE	5.0	U	ug/L	5.0	VG	11/15/00	11/07/00
625	2-CHLORONAPHTHALENE	5.0	U	ug/L	5.0	VG	11/15/00	11/07/00
625	4-CHLORO-3-METHYLPHENOL	20	U	ug/L	20	VG	11/15/00	11/07/00
625	2-CHLOROPHENOL	5.0	U	ug/L	5.0	VG	11/15/00	11/07/00
625	4-CHLOROPHENYL PHENYL ETHER	5.0	U	ug/L	5.0	VG	11/15/00	11/07/00
625	CHRYSENE	5.0	U	ug/L	5.0	VG	11/15/00	11/07/00
625	DIBENZO(A,H)ANTHRACENE	5.0	U	ug/L	5.0	VG	11/15/00	11/07/00
625	DI-n-BUTYLPHTHALATE	5.0	U	ug/L	5.0	VG	11/15/00	11/07/00
625	1,2-DICHLOROBENZENE	5.0	U	ug/L	5.0	VG	11/15/00	11/07/00
625	1,3-DICHLOROBENZENE	5.0	U	ug/L	5.0	VG	11/15/00	11/07/00
625	1,4-DICHLOROBENZENE	5.0	U	ug/L	5.0	VG	11/15/00	11/07/00
625	3,3'-DICHLOROBENZIDINE	20	U	ug/L	20	VG	11/15/00	11/07/00
625	2,4-DICHLOROPHENOL	5.0	U	ug/L	5.0	VG	11/15/00	11/07/00
625	DIETHYLPHTHALATE	5.0	U	ug/L	5.0	VG	11/15/00	11/07/00
625	2,4-DIMETHYLPHENOL	5.0	U	ug/L	5.0	VG	11/15/00	11/07/00
625	DIMETHYLPHTHALATE	5.0	U	ug/L	5.0	VG	11/15/00	11/07/00
625	4,6-DINITRO-2-METHYLPHENOL	20	U	ug/L	20	VG	11/15/00	11/07/00

MR. RICHARD MOULTON
 CITY OF FORT MYERS
 2751 JACKSONVILLE ST
 FORT MYERS, FL 33916



ANALYTICAL REPORT

Submission Number: 11000170 Client's P.O. Number:
 Date Received: 11/07/00 Project Number:
 Date Reported: 11/29/00 Project Name:
 Elab Report Name: Finalnew->Final2.RP1

Lab Sample Number: 0011170 1 Date Sampled: 11/06/00
 Client Sample Number:
 Sample Matrix: DRINKING WATER
 Sample Description: DEEP WELL P3

Method	Analyte	Result	Q	Units	Reporting		Date		
					Limit	Analyst	Analyzed	Prepared	
<u>PRIORITY POLLUTANT B/N/A EXTRACTABLES</u>									
625	2,4-DINITROPHENOL	20	U	ug/L	20	VG	11/15/00	11/07/00	
625	2,4-DINITROTOLUENE	5.0	U	ug/L	5.0	VG	11/15/00	11/07/00	
625	2,6-DINITROTOLUENE	5.0	U	ug/L	5.0	VG	11/15/00	11/07/00	
625	1,2-DIPHENYLHYDRAZINE	5.0	U	ug/L	5.0	VG	11/15/00	11/07/00	
625	DI-n-OCTYLPHTHALATE	5.0	U	ug/L	5.0	VG	11/15/00	11/07/00	
625	DIOXIN (2,3,7,8-TCDD) (SCREEN)	100	U	ug/L	100	VG	11/15/00	11/07/00	
625	FLUORANTHENE	5.0	U	ug/L	5.0	VG	11/15/00	11/07/00	
625	FLUORENE	5.0	U	ug/L	5.0	VG	11/15/00	11/07/00	
625	HEXACHLOROENZENE	5.0	U	ug/L	5.0	VG	11/15/00	11/07/00	
625	HEXACHLOROBUTADIENE	5.0	U	ug/L	5.0	VG	11/15/00	11/07/00	
625	HEXACHLOROCYCLOPENTADIENE	5.0	U	ug/L	5.0	VG	11/15/00	11/07/00	
625	HEXACHLOROETHANE	5.0	U	ug/L	5.0	VG	11/15/00	11/07/00	
625	INDENO (1,2,3-CD) PYRENE	5.0	U	ug/L	5.0	VG	11/15/00	11/07/00	
625	ISOPHORONE	5.0	U	ug/L	5.0	VG	11/15/00	11/07/00	
625	NAPHTHALENE	5.0	U	ug/L	5.0	VG	11/15/00	11/07/00	
625	NITROBENZENE	5.0	U	ug/L	5.0	VG	11/15/00	11/07/00	
625	2-NITROPHENOL	5.0	U	ug/L	5.0	VG	11/15/00	11/07/00	
625	4-NITROPHENOL	20	U	ug/L	20	VG	11/15/00	11/07/00	
625	N-NITROSODIMETHYLAMINE	5.0	U	ug/L	5.0	VG	11/15/00	11/07/00	
625	N-NITROSODIPHENYLAMINE	5.0	U	ug/L	5.0	VG	11/15/00	11/07/00	
625	N-NITROSODI-n-PROPYLAMINE	5.0	U	ug/L	5.0	VG	11/15/00	11/07/00	
625	PENTACHLOROPHENOL	20	U	ug/L	20	VG	11/15/00	11/07/00	
625	PHENANTHRENE	5.0	U	ug/L	5.0	VG	11/15/00	11/07/00	
625	PHENOL	5.0	U	ug/L	5.0	VG	11/15/00	11/07/00	
625	PYRENE	5.0	U	ug/L	5.0	VG	11/15/00	11/07/00	
625	1,2,4-TRICHLOROBENZENE	5.0	U	ug/L	5.0	VG	11/15/00	11/07/00	
625	2,4,6-TRICHLOROPHENOL	5.0	U	ug/L	5.0	VG	11/15/00	11/07/00	
<u>DRINKING WATER REG. VOLATILE ORGANICS</u>									
502.2	BENZENE	0.50	U	ug/L	0.50	RME	11/14/00		
502.2	CARBON TETRACHLORIDE	0.50	U	ug/L	0.50	RME	11/14/00		
502.2	o-DICHLOROBENZENE	0.50	U	ug/L	0.50	RME	11/14/00		

MR. RICHARD MOULTON
 CITY OF FORT MYERS
 2751 JACKSONVILLE ST
 FORT MYERS, FL 33916



ANALYTICAL REPORT

Submission Number: 11000170 Client's P.O. Number:
 Date Received: 11/07/00 Project Number:
 Date Reported: 11/29/00 Project Name:
 Elab Report Name: Finalnew->Final2.RP1

Lab Sample Number: 0011170 1 Date Sampled: 11/06/00
 Client Sample Number: Sample Matrix: DRINKING WATER
 Sample Description: DEEP WELL P3

Method	Analyte	Result	Q	Units	Reporting Limit	Analyst	Date Analyzed	Prepared
<u>DRINKING WATER REG. VOLATILE ORGANICS</u>								
502.2	p-DICHLOROBENZENE	0.50	U	ug/L	0.50	RME	11/14/00	
502.2	1,2-DICHLOROETHANE	0.50	U	ug/L	0.50	RME	11/14/00	
502.2	1,1-DICHLOROETHENE	0.50	U	ug/L	0.50	RME	11/14/00	
502.2	cis-1,2-DICHLOROETHYLENE	0.50	U	ug/L	0.50	RME	11/14/00	
502.2	trans-1,2-DICHLOROETHYLENE	0.50	U	ug/L	0.50	RME	11/14/00	
502.2	DICHLOROMETHANE	0.50	U	ug/L	0.50	RME	11/14/00	
502.2	1,2-DICHLOROPROPANE	0.50	U	ug/L	0.50	RME	11/14/00	
502.2	ETHYLBENZENE	0.50	U	ug/L	0.50	RME	11/14/00	
502.2	MONOCHLOROBENZENE	0.50	U	ug/L	0.50	RME	11/14/00	
502.2	STYRENE	0.50	U	ug/L	0.50	RME	11/14/00	
502.2	TETRACHLOROETHYLENE	0.50	U	ug/L	0.50	RME	11/14/00	
502.2	TOLUENE	0.50	U	ug/L	0.50	RME	11/14/00	
502.2	1,2,4-TRICHLOROBENZENE	0.50	U	ug/L	0.50	RME	11/14/00	
502.2	1,1,1-TRICHLOROETHANE	0.50	U	ug/L	0.50	RME	11/14/00	
502.2	1,1,2-TRICHLOROETHANE	0.50	U	ug/L	0.50	RME	11/14/00	
502.2	TRICHLOROETHYLENE	0.50	U	ug/L	0.50	RME	11/14/00	
502.2	VINYL CHLORIDE	0.50	U	ug/L	0.50	RME	11/14/00	
502.2	XYLENES (Total)	0.50	U	ug/L	0.50	RME	11/14/00	
<u>DW CHLORINATED PESTICIDES & PCB</u>								
505	ALACHLOR	1.0	U	ug/L	1.0	TCZ	11/09/00	11/08/00
505	ATRAZINE	1.5	U	ug/L	1.5	TCZ	11/09/00	11/08/00
505	g-BHC (LINDANE)	0.010	U	ug/L	0.010	TCZ	11/09/00	11/08/00
505	CHLORDANE	0.020	U	ug/L	0.020	TCZ	11/09/00	11/08/00
505	ENDRIN	0.010	U	ug/L	0.010	TCZ	11/09/00	11/08/00
505	HEPTACHLOR	0.030	U	ug/L	0.030	TCZ	11/09/00	11/08/00
505	HEPTACHLOR EPOXIDE	0.010	U	ug/L	0.010	TCZ	11/09/00	11/08/00
505	HEXACHLOROBENZENE	0.10	U	ug/L	0.10	TCZ	11/09/00	11/08/00
505	HEXACHLOROCYCLOPENTADIENE	0.10	U	ug/L	0.10	TCZ	11/09/00	11/08/00
505	METHOXYCHLOR	0.050	U	ug/L	0.050	TCZ	11/09/00	11/08/00
505	SIMAZINE	1.5	U	ug/L	1.5	TCZ	11/09/00	11/08/00
505	TOXAPHENE	0.18	U	ug/L	0.18	TCZ	11/09/00	11/08/00

MR. RICHARD MOULTON
 CITY OF FORT MYERS
 2751 JACKSONVILLE ST
 FORT MYERS, FL 33916



ANALYTICAL REPORT

Submission Number: 11000170 Client's P.O. Number:
 Date Received: 11/07/00 Project Number:
 Date Reported: 11/29/00 Project Name:
 Elab Report Name: Finalnew->Final2.RP1

Lab Sample Number: 0011170 1 Date Sampled: 11/06/00
 Client Sample Number: Sample Matrix: DRINKING WATER
 Sample Description: DEEP WELL P3

Method	Analyte	Result	Q	Units	Reporting Limit	Analyst	Date Analyzed	Prepared
<u>DW CHLORINATED PESTICIDES & PCB</u>								
505	PCB 1016	0.10	U	ug/L	0.10	TCZ	11/09/00	11/08/00
505	PCB 1221	0.10	U	ug/L	0.10	TCZ	11/09/00	11/08/00
505	PCB 1232	0.10	U	ug/L	0.10	TCZ	11/09/00	11/08/00
505	PCB 1242	0.10	U	ug/L	0.10	TCZ	11/09/00	11/08/00
505	PCB 1248	0.10	U	ug/L	0.10	TCZ	11/09/00	11/08/00
505	PCB 1254	0.10	U	ug/L	0.10	TCZ	11/09/00	11/08/00
505	PCB 1260	0.10	U	ug/L	0.10	TCZ	11/09/00	11/08/00
505	TOTAL PCB'S	0.10	U	ug/L	0.10	TCZ	11/09/00	11/08/00
<u>DRINKING WATER ORGANIC HERBICIDES</u>								
515.1	2,4-D	0.10	U	ug/L	0.10	OAO	11/15/00	11/11/00
515.1	DALAPON	1.0	U	ug/L	1.0	OAO	11/15/00	11/11/00
515.1	DINOSEB	0.20	U	ug/L	0.20	OAO	11/15/00	11/11/00
515.1	PENTACHLOROPHENOL	0.040	U	ug/L	0.040	OAO	11/15/00	11/11/00
515.1	PICLORAM	0.10	U	ug/L	0.10	OAO	11/15/00	11/11/00
515.1	2,4,5-TP (SILVEX)	0.20	U	ug/L	0.20	OAO	11/15/00	11/11/00
<u>DRINKING WATER ORGANIC CARBAMATES</u>								
531.1	CARBOPURAN	2.0	U	ug/L	2.0	KHA	11/10/00	11/08/00
531.1	OXAMYL (VYDATE)	2.0	U	ug/L	2.0	KHA	11/10/00	11/08/00
<u>DW DISINFECTANT BY-PRODUCTS</u>								
504.1	1,2-DIBROMO-3-CHLOROPROPANE	0.020	U	ug/L	0.020	OAO	11/10/00	11/09/00
504.1	ETHYLENE DIBROMIDE	0.010	U	ug/L	0.010	OAO	11/10/00	11/09/00
<u>DW MISC. SOC'S - GLYPHOSATE</u>								
547	GLYPHOSATE	6.0	U	ug/L	6.0	LMA/KHA	11/11/00	
<u>DW MISC. SOC'S - ENDOTHALL</u>								
548.1	ENDOTHALL	9.0	U	ug/L	9.0	TKA	11/12/00	11/10/00
<u>DW MISC. SOC'S - DIQUAT</u>								
549.1	DIQUAT	0.40	U	ug/L	0.40	KHA	11/08/00	11/08/00
<u>DW ADIPATES, PHTHALATES, AND PAH'S</u>								
525.2	BENZO (A) PYRENE	0.10	U	ug/L	0.10	TKA	11/16/00	11/15/00
525.2	DI (2-ETHYLHEXYL) PHTHALATE	2.0	U	ug/L	2.0	TKA	11/16/00	11/15/00
525.2	DI (2-ETHYLHEXYL) ADIPATE	1.6	U	ug/L	1.6	TKA	11/16/00	11/15/00

MR. RICHARD MOULTON
 CITY OF FORT MYERS
 2751 JACKSONVILLE ST
 FORT MYERS, FL 33916



ANALYTICAL REPORT

Submission Number: 11000170 Client's P.O. Number:
 Date Received: 11/07/00 Project Number:
 Date Reported: 11/29/00 Project Name:
 Elab Report Name: Finalnew->Final2.RP1

Lab Sample Number: 0011170 1 Date Sampled: 11/06/00
 Client Sample Number: Sample Matrix: DRINKING WATER
 Sample Description: DEEP WELL P3

Method	Analyte	Result	Q	Units	Reporting		Date	
					Limit	Analyst	Analyzed	Prepared
SM2120B	COLOR	5.0	U	UNIT	5.0	MRO	11/07/00	16:27
120.1	SPECIFIC CONDUCTANCE	3770		umhos/cm	1.0	MRO	11/07/00	
SM2150B	ODOR	2.0		TON	1.0	MRO	11/07/00	16:25
150.1	pH	7.45		UNIT	N/A	MRO	11/07/00	16:57
SM2540C	TOTAL DISSOLVED SOLIDS (TDS)	2200		mg/L	5.0	MRO	11/08/00	
SM4500CN-E	CYANIDE - TOTAL	0.010	U	mg/L	0.010	TPE	11/10/00	
370.1	DISSOLVED SILICA	15		mg/L	1.0	KFE	11/14/00	
310.1	HYDROXIDE ALK. as CaCO3	5.0	U	mg/L	5.0	MMA	11/09/00	
SM4500NH3D	AMMONIA NITROGEN (as N)	0.35		mg/L	0.050	TPE	11/10/00	
415.1	TOTAL ORGANIC CARBON (TOC)	1.0	U	mg/L	1.0	TPE	11/10/00	
SM5540C	SURFACTANTS (MBAS)	0.11		mg/L	0.10	TPE	11/07/00	17:20
900.0	GROSS ALPHA	12.7+/-2.9		pCi/L		MJN	11/13/00	
903.1	RADIUM 226	9.9+/-0.5		pCi/L		MJN	11/16/00	
EPA ALT.	RADIUM 228	2.0+/-0.06		pCi/L		MJN	11/16/00	
300.0	CHLORIDE	910		mg/L	0.50	KFE	11/07/00	
300.0	FLUORIDE	1.6		mg/L	0.050	KFE	11/07/00	
300.0	NITRATE NITROGEN (as N)	2.8		mg/L	0.050	KFE	11/07/00	10:28
300.0	NITRITE NITROGEN (as N)	0.050	U	mg/L	0.050	KFE	11/07/00	10:28
300.0	SULFATE	350		mg/L	0.50	KFE	11/07/00	
SM4500C1-D	CHLORINE DEMAND	9.0		mg/L	0.020	JB	11/07/00	
	TIME - INCUBATION (SDS)	168		HOURS	N/A	JB	11/07/00	
SM4500C1G	CHLORINE DOSE (SDS) (ICR only)	23		mg/L	0.050	JB	11/07/00	
SM4500C1G	FREE RESIDUAL CHLORINE (SDS)	3.3		mg/L	0.050	JB	11/14/00	
150.1	pH - BUFFERED (SDS)	7.13		UNIT	N/A	JB	11/07/00	
SM2550B	TEMPERATURE - INCUBATION (SDS)	25.0		DEG C	N/A	JB	11/07/00	
SM3113B	ANTIMONY (TOTAL)	3.0	U	ug/L	3.0	EM	11/13/00	
SM3113B	LEAD (TOTAL)	1.0	U	ug/L	1.0	JAS	11/10/00	
245.1	MERCURY	0.20	U	ug/L	0.20	EM	11/09/00	
SM3113B	SELENIUM (TOTAL)	2.0	U	ug/L	2.0	EM	11/13/00	
200.9	THALLIUM (TOTAL)	1.0	U	ug/L	1.0	EM	11/13/00	
200.7	STRONTIUM (TOTAL)	18000		ug/L	10	EM	11/10/00	
200.7	ALUMINUM (TOTAL)	100	U	ug/L	100	EM	11/08/00	

MR. RICHARD MOULTON
 CITY OF FORT MYERS
 2751 JACKSONVILLE ST
 FORT MYERS, FL 33916



ANALYTICAL REPORT

Submission Number: 11000170 Client's P.O. Number:
 Date Received: 11/07/00 Project Number:
 Date Reported: 11/29/00 Project Name:
 Elab Report Name: Finalnew->Final2.RP1

Lab Sample Number: 0011170 1 Date Sampled: 11/06/00
 Client Sample Number: Sample Matrix: DRINKING WATER
 Sample Description: DEEP WELL P3

Method	Analyte	Result	Q	Units	Reporting Limit	Analyst	Date Analyzed	Prepared
200.7	ARSENIC (TOTAL)	5.0	U	ug/L	5.0	EM	11/08/00	
200.7	BARIUM (TOTAL)	26		ug/L	10	EM	11/08/00	
200.7	BERYLLIUM (TOTAL)	1.0	U	ug/L	1.0	EM	11/08/00	
200.7	CADMIUM (TOTAL)	1.0	U	ug/L	1.0	EM	11/08/00	
200.7	CHROMIUM (TOTAL)	5.0	U	ug/L	5.0	EM	11/08/00	
200.7	COPPER (TOTAL)	10	U	ug/L	10	EM	11/08/00	
200.7	IRON (TOTAL)	40	U	ug/L	40	EM	11/08/00	
200.7	MANGANESE (TOTAL)	5.0	U	ug/L	5.0	EM	11/08/00	
200.7	NICKEL (TOTAL)	10	U	ug/L	10	EM	11/08/00	
200.7	SILVER (TOTAL)	10	U	ug/L	10	EM	11/08/00	
200.7	SODIUM (TOTAL)	480		mg/L	0.50	EM	11/08/00	
200.7	ZINC (TOTAL)	20	U	ug/L	20	EM	11/08/00	
	CALCIUM (TOTAL)	120				EM	11/08/00	
	MAGNESIUM (TOTAL)	95				EM	11/08/00	
	<u>PRIORITY POLLUTANT PEST. AND PCB'S</u>							
608	ALDRIN	0.010	U	ug/L	0.010	TCZ	11/11/00	11/07/00
608	a-BHC	0.010	U	ug/L	0.010	TCZ	11/11/00	11/07/00
608	b-BHC	0.040	U	ug/L	0.040	TCZ	11/11/00	11/07/00
608	d-BHC	0.040	U	ug/L	0.040	TCZ	11/11/00	11/07/00
608	g-BHC (LINDANE)	0.040	U	ug/L	0.040	TCZ	11/11/00	11/07/00
608	CHLORDANE (tech.)	1.0	U	ug/L	1.0	TCZ	11/11/00	11/07/00
608	4,4'-DDD	0.040	U	ug/L	0.040	TCZ	11/11/00	11/07/00
608	4,4'-DDE	0.040	U	ug/L	0.040	TCZ	11/11/00	11/07/00
608	4,4'-DDT	0.040	U	ug/L	0.040	TCZ	11/11/00	11/07/00
608	DIELDRIN	0.010	U	ug/L	0.010	TCZ	11/11/00	11/07/00
608	ENDOSULFAN I	0.040	U	ug/L	0.040	TCZ	11/11/00	11/07/00
608	ENDOSULFAN II	0.040	U	ug/L	0.040	TCZ	11/11/00	11/07/00
608	ENDOSULFAN SULFATE	0.040	U	ug/L	0.040	TCZ	11/11/00	11/07/00
608	ENDRIN	0.020	U	ug/L	0.020	TCZ	11/11/00	11/07/00
608	ENDRIN ALDEHYDE	0.040	U	ug/L	0.040	TCZ	11/11/00	11/07/00
608	HEPTACHLOR	0.040	U	ug/L	0.040	TCZ	11/11/00	11/07/00
608	HEPTACHLOR EPOXIDE	0.040	U	ug/L	0.040	TCZ	11/11/00	11/07/00

MR. RICHARD MOULTON
 CITY OF FORT MYERS
 2751 JACKSONVILLE ST
 FORT MYERS, FL 33916



ANALYTICAL REPORT

Submission Number: 11000170 Client's P.O. Number:
 Date Received: 11/07/00 Project Number:
 Date Reported: 11/29/00 Project Name:
 Elab Report Name: Finalnew->Final2.RP1

Lab Sample Number: 0011170 1 Date Sampled: 11/06/00
 Client Sample Number: Sample Matrix: DRINKING WATER
 Sample Description: DEEP WELL P3

Method	Analyte	Result	Q	Units	Reporting Limit	Analyst	Date Analyzed	Prepared
<u>PRIORITY POLLUTANT PEST. AND PCB'S</u>								
608	METHOXYCHLOR	0.040	U	ug/L	0.040	TCZ	11/11/00	11/07/00
608	TOXAPHENE	1.0	U	ug/L	1.0	TCZ	11/11/00	11/07/00
608	PCB 1016	1.0	U	ug/L	1.0	TCZ	11/11/00	11/07/00
608	PCB 1221	1.0	U	ug/L	1.0	TCZ	11/11/00	11/07/00
608	PCB 1232	1.0	U	ug/L	1.0	TCZ	11/11/00	11/07/00
608	PCB 1242	1.0	U	ug/L	1.0	TCZ	11/11/00	11/07/00
608	PCB 1248	1.0	U	ug/L	1.0	TCZ	11/11/00	11/07/00
608	PCB 1254	1.0	U	ug/L	1.0	TCZ	11/11/00	11/07/00
608	PCB 1260	1.0	U	ug/L	1.0	TCZ	11/11/00	11/07/00
<u>TRIHALOMETHANES (THMS)</u>								
502.2	BROMODICHLOROMETHANE	0.00050	U	mg/L	0.00050	RME	11/14/00	
502.2	BROMOFORM	0.00050	U	mg/L	0.00050	RME	11/14/00	
502.2	CHLORODIBROMOMETHANE	0.00050	U	mg/L	0.00050	RME	11/14/00	
502.2	CHLOROFORM	0.00050	U	mg/L	0.00050	RME	11/14/00	
502.2	TOTAL TRIHALOMETHANES	0.00050	U	mg/L	0.00050	RME	11/14/00	
HACH	RESIDUAL CHLORINE	2.0	U	mg/L	2.0	RME	11/14/00	
<u>TRIHALOMETHANES (THMS) - FP</u>								
330.2	RESIDUAL CHLORINE	2.0	U	mg/L	2.0	RME	11/15/00	
502.2	BROMODICHLOROMETHANE	0.0048		mg/L	0.00050	RME	11/15/00	
502.2	BROMOFORM	0.073		mg/L	0.0025	RME	11/15/00	
502.2	CHLORODIBROMOMETHANE	0.032		mg/L	0.00050	RME	11/15/00	
502.2	CHLOROFORM	0.0022		mg/L	0.00050	RME	11/15/00	
502.2	TOTAL TRIHALOMETHANES (FP)	0.11		mg/L	0.0025	RME	11/15/00	
<u>PRIORITY POLLUTANT VOLATILE ORGANICS</u>								
624	ACROLEIN	20	U	ug/L	20	JSA	11/14/00	
624	ACRYLONITRILE	20	U	ug/L	20	JSA	11/14/00	
624	BENZENE	1.0	U	ug/L	1.0	JSA	11/14/00	
624	BROMODICHLOROMETHANE	1.0	U	ug/L	1.0	JSA	11/14/00	
624	BROMOFORM	1.0	U	ug/L	1.0	JSA	11/14/00	
624	BROMOMETHANE	1.0	U	ug/L	1.0	JSA	11/14/00	
624	CARBON TETRACHLORIDE	1.0	U	ug/L	1.0	JSA	11/14/00	

MR. RICHARD MOULTON
CITY OF FORT MYERS
2751 JACKSONVILLE ST
FORT MYERS, FL 33916



ANALYTICAL REPORT

Page 8

Submission Number: 11000170 Client's P.O. Number:
Date Received: 11/07/00 Project Number:
Date Reported: 11/29/00 Project Name:
Elab Report Name: Finalnew->Final2.RP1

Lab Sample Number: 0011170 1 Date Sampled: 11/06/00
Client Sample Number: Sample Matrix: DRINKING WATER
Sample Description: DEEP WELL P3

Method	Analyte	Result	Q	Units	Reporting Limit	Analyst	Date Analyzed	Prepared
<u>PRIORITY POLLUTANT VOLATILE ORGANICS</u>								
624	CHLOROBENZENE	1.0	U	ug/L	1.0	JSA	11/14/00	
624	CHLOROETHANE	1.0	U	ug/L	1.0	JSA	11/14/00	
624	2-CHLOROETHYL VINYL ETHER	10	U	ug/L	10	JSA	11/14/00	
624	CHLOROFORM	1.0	U	ug/L	1.0	JSA	11/14/00	
624	CHLOROMETHANE	1.0	U	ug/L	1.0	JSA	11/14/00	
624	DIBROMOCHLOROMETHANE	1.0	U	ug/L	1.0	JSA	11/14/00	
624	1,2-DICHLOROBENZENE	1.0	U	ug/L	1.0	JSA	11/14/00	
624	1,3-DICHLOROBENZENE	1.0	U	ug/L	1.0	JSA	11/14/00	
624	1,4-DICHLOROBENZENE	1.0	U	ug/L	1.0	JSA	11/14/00	
624	1,1-DICHLOROETHANE	1.0	U	ug/L	1.0	JSA	11/14/00	
624	1,2-DICHLOROETHANE	1.0	U	ug/L	1.0	JSA	11/14/00	
624	1,1-DICHLOROETHENE	1.0	U	ug/L	1.0	JSA	11/14/00	
624	trans-1,2-DICHLOROETHENE	1.0	U	ug/L	1.0	JSA	11/14/00	
624	1,2-DICHLOROPROPANE	1.0	U	ug/L	1.0	JSA	11/14/00	
624	cis-1,3-DICHLOROPROPENE	5.0	U	ug/L	5.0	JSA	11/14/00	
624	trans-1,3-DICHLOROPROPENE	5.0	U	ug/L	5.0	JSA	11/14/00	
624	ETHYLBENZENE	1.0	U	ug/L	1.0	JSA	11/14/00	
624	METHYLENE CHLORIDE	5.0	U	ug/L	5.0	JSA	11/14/00	
624	1,1,2,2-TETRACHLOROETHANE	1.0	U	ug/L	1.0	JSA	11/14/00	
624	TETRACHLOROETHENE	1.0	U	ug/L	1.0	JSA	11/14/00	
624	TOLUENE	1.0	U	ug/L	1.0	JSA	11/14/00	
624	1,1,1-TRICHLOROETHANE	1.0	U	ug/L	1.0	JSA	11/14/00	
624	1,1,2-TRICHLOROETHANE	1.0	U	ug/L	1.0	JSA	11/14/00	
624	TRICHLOROETHENE	1.0	U	ug/L	1.0	JSA	11/14/00	
624	TRICHLOROFLUOROMETHANE	1.0	U	ug/L	1.0	JSA	11/14/00	
624	VINYL CHLORIDE	1.0	U	ug/L	1.0	JSA	11/14/00	

Data Qualifier Code Key:

U - The analyte was analyzed for, but was not detected above the reported sample quantitation limit.

MR. RICHARD MOULTON
CITY OF FORT MYERS
2751 JACKSONVILLE ST
FORT MYERS, FL 33916



ANALYTICAL REPORT

Page 9

Submission Number: 11000170 Client's P.O. Number:
Date Received: 11/07/00 Project Number:
Date Reported: 11/29/00 Project Name:
Elab Report Name: Finalnew->Final2.RP1

CERTIFICATION: All analytical data reported above were obtained using the specified methods and were validated by our laboratory quality control system. This laboratory follows an approved quality assurance program.

Respectfully submitted:



Paul K. Canevaro
Laboratory Director

APPENDIX J.2

Well P-4 Ambient Water Quality Results

MR. RICHARD MOULTON
 CITY OF FORT MYERS
 2751 JACKSONVILLE ST
 FORT MYERS, FL 33916



ANALYTICAL REPORT

Page 1

Submission Number: 11000355 Client's P.O. Number:
 Date Received: 11/14/00 Project Number:
 Date Reported: 12/06/00 Project Name:
 Elab Report Name: Finalnew->Final12.RP1

Lab Sample Number: 0011355 1 Date Sampled: 11/13/00
 Client Sample Number: Sample Matrix: DRINKING WATER
 Sample Description: DEEP WELL#4

Method	Analyte	Result	Q	Units	Limit	Reporting Analyst	Date Analyzed	Prepared
PRIORITY POLLUTANT B/N/A EXTRACTABLES								
625	ACENAPHTHENE	5.0	U	ug/L	5.0	VG	11/30/00	11/20/00
625	ACENAPHTHYLENE	5.0	U	ug/L	5.0	VG	11/30/00	11/20/00
625	ANTHRACENE	5.0	U	ug/L	5.0	VG	11/30/00	11/20/00
625	BENZIDINE	25	U	ug/L	25	VG	11/30/00	11/20/00
625	BENZ(A)ANTHRACENE	5.0	U	ug/L	5.0	VG	11/30/00	11/20/00
625	BENZO(B)FLUORANTHENE	5.0	U	ug/L	5.0	VG	11/30/00	11/20/00
625	BENZO(K)FLUORANTHENE	5.0	U	ug/L	5.0	VG	11/30/00	11/20/00
625	BENZO(G,H,I)PERYLENE	5.0	U	ug/L	5.0	VG	11/30/00	11/20/00
625	BENZO(A)PYRENE	5.0	U	ug/L	5.0	VG	11/30/00	11/20/00
625	BIS(2-CHLOROETHOXY) METHANE	5.0	U	ug/L	5.0	VG	11/30/00	11/20/00
625	BIS(2-CHLOROETHYL) ETHER	5.0	U	ug/L	5.0	VG	11/30/00	11/20/00
625	BIS(2-CHLOROISOPROPYL) ETHER	5.0	U	ug/L	5.0	VG	11/30/00	11/20/00
625	BIS(2-ETHYLHEXYL) PHTHALATE	5.0	U	ug/L	5.0	VG	11/30/00	11/20/00
625	4-BROMOPHENYL PHENYL ETHER	5.0	U	ug/L	5.0	VG	11/30/00	11/20/00
625	BUTYL BENZYL PHTHALATE	5.0	U	ug/L	5.0	VG	11/30/00	11/20/00
625	2-CHLORONAPHTHALENE	5.0	U	ug/L	5.0	VG	11/30/00	11/20/00
625	4-CHLORO-3-METHYLPHENOL	20	U	ug/L	20	VG	11/30/00	11/20/00
625	2-CHLOROPHENOL	5.0	U	ug/L	5.0	VG	11/30/00	11/20/00
625	4-CHLOROPHENYL PHENYL ETHER	5.0	U	ug/L	5.0	VG	11/30/00	11/20/00
625	CHRYSENE	5.0	U	ug/L	5.0	VG	11/30/00	11/20/00
625	DIBENZO(A,H)ANTHRACENE	5.0	U	ug/L	5.0	VG	11/30/00	11/20/00
625	DI-n-BUTYLPHTHALATE	5.0	U	ug/L	5.0	VG	11/30/00	11/20/00
625	1,2-DICHLOROBENZENE	5.0	U	ug/L	5.0	VG	11/30/00	11/20/00
625	1,3-DICHLOROBENZENE	5.0	U	ug/L	5.0	VG	11/30/00	11/20/00
625	1,4-DICHLOROBENZENE	5.0	U	ug/L	5.0	VG	11/30/00	11/20/00
625	1,3'-DICHLOROBENZIDINE	20	U	ug/L	20	VG	11/30/00	11/20/00
625	2,4-DICHLOROPHENOL	5.0	U	ug/L	5.0	VG	11/30/00	11/20/00
625	DIETHYLPHTHALATE	5.0	U	ug/L	5.0	VG	11/30/00	11/20/00
625	2,4-DIMETHYLPHENOL	5.0	U	ug/L	5.0	VG	11/30/00	11/20/00
625	DIMETHYLPHTHALATE	5.0	U	ug/L	5.0	VG	11/30/00	11/20/00
625	4,6-DINITRO-2-METHYLPHENOL	20	U	ug/L	20	VG	11/30/00	11/20/00

MR. RICHARD MOULTON
 CITY OF FORT MYERS
 2751 JACKSONVILLE ST
 FORT MYERS, FL 33916



ANALYTICAL REPORT

Submission Number: 11000355 Client's P.O. Number:
 Date Received: 11/14/00 Project Number:
 Date Reported: 12/06/00 Project Name:
 Elab Report Name: Finalnew->Final2.RP1

Lab Sample Number: 0011355 1 Date Sampled: 11/13/00
 Client Sample Number: Sample Matrix: DRINKING WATER
 Sample Description: DEEP WELL#4

Method	Analyte	Result	Q	Units	Limit	Reporting Analyst	Date Analyzed	Prepared
<u>PRIORITY POLLUTANT B/N/A EXTRACTABLES</u>								
625	2,4-DINITROPHENOL	20	U	ug/L	20	VG	11/30/00	11/20/00
625	2,4-DINITROTOLUENE	5.0	U	ug/L	5.0	VG	11/30/00	11/20/00
625	2,6-DINITROTOLUENE	5.0	U	ug/L	5.0	VG	11/30/00	11/20/00
625	1,2-DIPHENYLHYDRAZINE	5.0	U	ug/L	5.0	VG	11/30/00	11/20/00
625	DI-n-OCTYLPHTHALATE	5.0	U	ug/L	5.0	VG	11/30/00	11/20/00
625	DIOXIN (2,3,7,8-TCDD) (SCREEN)	100	U	ug/L	100	VG	11/30/00	11/20/00
625	FLUORANTHENE	5.0	U	ug/L	5.0	VG	11/30/00	11/20/00
625	FLUORENE	5.0	U	ug/L	5.0	VG	11/30/00	11/20/00
625	HEXACHLOROBENZENE	5.0	U	ug/L	5.0	VG	11/30/00	11/20/00
625	HEXACHLOROBUTADIENE	5.0	U	ug/L	5.0	VG	11/30/00	11/20/00
625	HEXACHLOROCYCLOPENTADIENE	5.0	U	ug/L	5.0	VG	11/30/00	11/20/00
625	HEXACHLOROETHANE	5.0	U	ug/L	5.0	VG	11/30/00	11/20/00
625	INDENO (1,2,3-CD) PYRENE	5.0	U	ug/L	5.0	VG	11/30/00	11/20/00
625	ISOPHORONE	5.0	U	ug/L	5.0	VG	11/30/00	11/20/00
625	NAPHTHALENE	5.0	U	ug/L	5.0	VG	11/30/00	11/20/00
625	NITROBENZENE	5.0	U	ug/L	5.0	VG	11/30/00	11/20/00
625	2-NITROPHENOL	5.0	U	ug/L	5.0	VG	11/30/00	11/20/00
625	4-NITROPHENOL	20	U	ug/L	20	VG	11/30/00	11/20/00
625	N-NITROSODIMETHYLAMINE	5.0	U	ug/L	5.0	VG	11/30/00	11/20/00
625	N-NITROSODIPHENYLAMINE	5.0	U	ug/L	5.0	VG	11/30/00	11/20/00
625	N-NITROSODI-n-PROPYLAMINE	5.0	U	ug/L	5.0	VG	11/30/00	11/20/00
625	PENTACHLOROPHENOL	20	U	ug/L	20	VG	11/30/00	11/20/00
625	PHENANTHRENE	5.0	U	ug/L	5.0	VG	11/30/00	11/20/00
625	PHENOL	5.0	U	ug/L	5.0	VG	11/30/00	11/20/00
625	PYRENE	5.0	U	ug/L	5.0	VG	11/30/00	11/20/00
625	1,2,4-TRICHLOROBENZENE	5.0	U	ug/L	5.0	VG	11/30/00	11/20/00
625	2,4,6-TRICHLOROPHENOL	5.0	U	ug/L	5.0	VG	11/30/00	11/20/00
<u>DRINKING WATER REG. VOLATILE ORGANICS</u>								
502.2	BENZENE	0.50	U	ug/L	0.50	RME	11/21/00	
502.2	CARBON TETRACHLORIDE	0.50	U	ug/L	0.50	RME	11/21/00	
502.2	o-DICHLOROBENZENE	0.50	U	ug/L	0.50	RME	11/21/00	

MR. RICHARD MOULTON
 CITY OF FORT MYERS
 2751 JACKSONVILLE ST
 FORT MYERS, FL 33916



ANALYTICAL REPORT

Submission Number: 11000355 Client's P.O. Number:
 Date Received: 11/14/00 Project Number:
 Date Reported: 12/06/00 Project Name:
 Elab Report Name: Finalnew->Final2.RP1

Lab Sample Number: 0011355 1 Date Sampled: 11/13/00
 Client Sample Number:
 Sample Description: DEEP WELL#4 Sample Matrix: DRINKING WATER

Method	Analyte	Result	Q	Units	Reporting Limit	Analyst	Date Analyzed	Prepared
DRINKING WATER REG. VOLATILE ORGANICS								
502.2	p-DICHLOROBENZENE	0.50	U	ug/L	0.50	RME	11/21/00	
502.2	1,2-DICHLOROETHANE	0.50	U	ug/L	0.50	RME	11/21/00	
502.2	1,1-DICHLOROETHENE	0.50	U	ug/L	0.50	RME	11/21/00	
502.2	cis-1,2-DICHLOROETHYLENE	0.50	U	ug/L	0.50	RME	11/21/00	
502.2	trans-1,2-DICHLOROETHYLENE	0.50	U	ug/L	0.50	RME	11/21/00	
502.2	DICHLOROMETHANE	0.50	U	ug/L	0.50	RME	11/21/00	
502.2	1,2-DICHLOROPROPANE	0.50	U	ug/L	0.50	RME	11/21/00	
502.2	ETHYLBENZENE	0.50	U	ug/L	0.50	RME	11/21/00	
502.2	MONOCHLOROBENZENE	0.50	U	ug/L	0.50	RME	11/21/00	
502.2	STYRENE	0.50	U	ug/L	0.50	RME	11/21/00	
502.2	TETRACHLOROETHYLENE	0.50	U	ug/L	0.50	RME	11/21/00	
502.2	TOLUENE	0.50	U	ug/L	0.50	RME	11/21/00	
502.2	1,2,4-TRICHLOROBENZENE	0.50	U	ug/L	0.50	RME	11/21/00	
502.2	1,1,1-TRICHLOROETHANE	0.50	U	ug/L	0.50	RME	11/21/00	
502.2	1,1,2-TRICHLOROETHANE	0.50	U	ug/L	0.50	RME	11/21/00	
502.2	TRICHLOROETHYLENE	0.50	U	ug/L	0.50	RME	11/21/00	
502.2	VINYL CHLORIDE	0.50	U	ug/L	0.50	RME	11/21/00	
502.2	XYLENES (Total)	0.50	U	ug/L	0.50	RME	11/21/00	
DM CHLORINATED PESTICIDES & PCB								
505	ALACHLOR	1.0	U	ug/L	1.0	TCZ	11/16/00	11/15/00
505	ATRAZINE	1.5	U	ug/L	1.5	TCZ	11/16/00	11/15/00
505	g-BHC (LINDANE)	0.010	U	ug/L	0.010	TCZ	11/16/00	11/15/00
505	CHLORDANE	0.020	U	ug/L	0.020	TCZ	11/16/00	11/15/00
505	ENDRIN	0.010	U	ug/L	0.010	TCZ	11/16/00	11/15/00
505	HEPTACHLOR	0.030	U	ug/L	0.030	TCZ	11/16/00	11/15/00
505	HEPTACHLOR EPOXIDE	0.010	U	ug/L	0.010	TCZ	11/16/00	11/15/00
505	HEXACHLOROBENZENE	0.10	U	ug/L	0.10	TCZ	11/16/00	11/15/00
505	HEXACHLOROCYCLOPENTADIENE	0.10	U	ug/L	0.10	TCZ	11/16/00	11/15/00
505	METHOXYCHLOR	0.050	U	ug/L	0.050	TCZ	11/16/00	11/15/00
505	SIMAZINE	1.5	U	ug/L	1.5	TCZ	11/16/00	11/15/00
505	TOXAPHENE	0.18	U	ug/L	0.18	TCZ	11/16/00	11/15/00

MR. RICHARD MOULTON
 CITY OF FORT MYERS
 2751 JACKSONVILLE ST
 FORT MYERS, FL 33916



ANALYTICAL REPORT

Page 4

Submission Number: 11000355
 Date Received: 11/14/00
 Date Reported: 12/06/00

Client's P.O. Number:
 Project Number:
 Project Name:
 Elab Report Name: Finalnew->Final2.RP1

Lab Sample Number: 0011355 1
 Client Sample Number:
 Sample Description: DEEP WELL#4

Date Sampled: 11/13/00
 Sample Matrix: DRINKING WATER

Method	Analyte	Result	Q	Units	Limit	Reporting Analyst	Date Analyzed	Prepared
<u>DW CHLORINATED PESTICIDES & PCB</u>								
505	PCB 1016	0.10	U	ug/L	0.10	TCZ	11/16/00	11/15/00
505	PCB 1221	0.10	U	ug/L	0.10	TCZ	11/16/00	11/15/00
505	PCB 1232	0.10	U	ug/L	0.10	TCZ	11/16/00	11/15/00
505	PCB 1242	0.10	U	ug/L	0.10	TCZ	11/16/00	11/15/00
505	PCB 1246	0.10	U	ug/L	0.10	TCZ	11/16/00	11/15/00
505	PCB 1254	0.10	U	ug/L	0.10	TCZ	11/16/00	11/15/00
505	PCB 1260	0.10	U	ug/L	0.10	TCZ	11/16/00	11/15/00
505	TOTAL PCB'S	0.10	U	ug/L	0.10	TCZ	11/16/00	11/15/00
<u>DRINKING WATER ORGANIC HERBICIDES</u>								
515.1	2,4-D	0.10	U	ug/L	0.10	OAO	11/22/00	11/20/00
515.1	DALAPON	1.0	U	ug/L	1.0	OAO	11/22/00	11/20/00
515.1	DINoseb	0.20	U	ug/L	0.20	OAO	11/22/00	11/20/00
515.1	PENTACHLOROPHENOL	0.040	U	ug/L	0.040	OAO	11/22/00	11/20/00
515.1	PICLORAM	0.10	U	ug/L	0.10	OAO	11/22/00	11/20/00
515.1	2,4,5-TP (SILVEX)	0.20	U	ug/L	0.20	OAO	11/22/00	11/20/00
<u>DRINKING WATER ORGANIC CARBAMATES</u>								
531.1	CARBOFURAN	2.0	U	ug/L	2.0	LMA/KHA	11/16/00	
531.1	OXYMYL (VYDATE)	2.0	U	ug/L	2.0	LMA/KHA	11/16/00	
<u>DW DISINFECTANT BY-PRODUCTS</u>								
504.1	1,2-DIBROMO-3-CHLOROPROPANE	0.020	U	ug/L	0.020	OAO	11/15/00	11/15/00
504.1	ETHYLENE DIBROMIDE	0.010	U	ug/L	0.010	OAO	11/15/00	11/15/00
<u>DW MISC. SOC'S - GLYPHOSATE</u>								
547	GLYPHOSATE	6.0	U	ug/L	6.0	KHA	11/17/00	11/17/00
<u>DW MISC. SOC'S - ENDOTHALL</u>								
548.1	ENDOTHALL	9.0	U	ug/L	9.0	TKA	11/19/00	11/16/00
<u>DW MISC. SOC'S - DIQUAT</u>								
549.1	DIQUAT	0.40	U	ug/L	0.40	KHA	11/16/00	11/14/00
<u>DW ADIPATES, PHTHALATES, AND PAH'S</u>								
525.2	BENZO(A)PYRENE	0.10	U	ug/L	0.10	TKA	11/28/00	11/16/00
525.2	DI(2-ETHYLHEXYL) PHTHALATE	2.0	U	ug/L	2.0	TKA	11/28/00	11/16/00
525.2	DI(2-ETHYLHEXYL) ADIPATE	1.6	U	ug/L	1.6	TKA	11/28/00	11/16/00



MR. RICHARD MOULTON
 CITY OF FORT MYERS
 2751 JACKSONVILLE ST
 FORT MYERS, FL 33916

ANALYTICAL REPORT

Submission Number: 11000355 Client's P.O. Number:
 Date Received: 11/14/00 Project Number:
 Date Reported: 12/06/00 Project Name:
 Elab Report Name: Finalnew-0Final2.RP1

Lab Sample Number: 0011355 1 Date Sampled: 11/13/00
 Client Sample Number:
 Sample Description: DEEP WELL#4 Sample Matrix: DRINKING WATER

Method	Analyte	Result	Q	Units	Limit	Reporting Analyst	Date Analyzed	Prepared
SM2120B	COLOR	5.0	U	UNIT	5.0	MRO	11/14/00	18:02
120.1	SPECIFIC CONDUCTANCE	3180		umhos/cm	1.0	KF	11/14/00	
SM2150B	ODOR	9.0		TON	1.0	MRO	11/14/00	18:08
150.1	PH	7.34		UNIT	N/A	KF	11/14/00	17:58
SM2540C	TOTAL DISSOLVED SOLIDS (TDS)	1900		mg/L	5.0	MRO	11/16/00	
SM4500CN-E	CYANIDE - TOTAL	0.010	U	mg/L	0.010	TPE	11/21/00	
SM4500N03E	NITRATE NITROGEN (as N)	0.050	U	mg/L	0.050	TPE	11/15/00	10:04
SM4500N03E	NITRITE NITROGEN (as N)	0.050	U	mg/L	0.050	TPE	11/15/00	10:04
370.1	DISSOLVED SILICA	14		mg/L	1.0	KFE	11/21/00	
310.1	HYDROXIDE ALK. as CaCO3	5.0	U	mg/L	5.0	MMA	11/14/00	
SM4500NH3D	AMMONIA NITROGEN (as N)	0.40		mg/L	0.050	TPE	11/17/00	
415.1	TOTAL ORGANIC CARBON (TOC)	1.0	U	mg/L	1.0	MMA	11/20/00	
SM5540C	SURFACTANTS (MBAS)	0.10	U	mg/L	0.10	MMA	11/14/00	
900.0	GROSS ALPHA	9.4+/-3.4		pCi/L		FRS	11/24/00	
6M7500Ra	RADIUM 226	5.5+/-0.4		pCi/L		FRS	11/22/00	
SM7500Ra	RADIUM 228	1.0+/-0.6		pCi/L		FRS	11/22/00	
300.0	CHLORIDE	920		mg/L	10	KFE	11/15/00	
300.0	FLUORIDE	1.6		mg/L	1.0	KFE	11/15/00	
300.0	SULFATE	380		mg/L	10	KFE	11/15/00	
SM4500C1-D	CHLORINE DEMAND	9.1		mg/L	0.020	SY	11/14/00	
	TIME - INCUBATION (SDS)	168		HOURS	N/A	SY	11/14/00	
SM4500C1G	CHLORINE DOSE (SDS) (ICR only)	23		mg/L	0.050	SY	11/14/00	
SM4500C1G	FREE RESIDUAL CHLORINE (SDS)	4.6		mg/L	0.050	JB	11/21/00	
150.1	PH - BUFFERED (SDS)	7.20		UNIT	N/A	SY	11/14/00	
SM2550B	TEMPERATURE - INCUBATION (SDS)	25.0		DEG C	N/A	SY	11/14/00	
SM3113B	ANTIMONY (TOTAL)	3.0	U	ug/L	3.0	EM	11/16/00	
SM3113B	LEAD (TOTAL)	2.0	U	ug/L	2.0	EM	11/20/00	
245.1	MERCURY	0.20	U	ug/L	0.20	EM	11/15/00	
SM3113B	SELENIUM (TOTAL)	2.0	U	ug/L	2.0	JAS	11/21/00	
200.9	THALLIUM (TOTAL)	1.0	U	ug/L	1.0	EM	11/17/00	
200.7	STRONTIUM (TOTAL)	17000		ug/L	1000	EM	11/16/00	
200.7	ALUMINIUM (TOTAL)	100	U	ug/L	100	JAS	11/15/00	

MR. RICHARD MOULTON
 CITY OF FORT MYERS
 2751 JACKSONVILLE ST
 FORT MYERS, FL 33916



ANALYTICAL REPORT

Submission Number: 11000355 Client's P.O. Number:
 Date Received: 11/14/00 Project Number:
 Date Reported: 12/06/00 Project Name:
 Elab Report Name: Finalnew->Final2.RP1

Lab Sample Number: 0011355 1 Date Sampled: 11/13/00
 Client Sample Number: Sample Matrix: DRINKING WATER
 Sample Description: DEEP WELL#4

Method	Analyte	Result	Q	Units	Reporting Limit	Analyst	Date Analyzed	Prepared
200.7	ARSENIC (TOTAL)	5.0	U	ug/L	5.0	JAS	11/15/00	
200.7	BARIUM (TOTAL)	24		ug/L	10	JAS	11/15/00	
200.7	BERYLLIUM (TOTAL)	1.0	U	ug/L	1.0	JAS	11/15/00	
200.7	CADMIUM (TOTAL)	1.0	U	ug/L	1.0	JAS	11/15/00	
200.7	CALCIUM (TOTAL)	110		mg/L	0.50	JAS	11/15/00	
200.7	CHROMIUM (TOTAL)	5.0	U	ug/L	5.0	JAS	11/15/00	
200.7	COPPER (TOTAL)	10	U	ug/L	10	JAS	11/15/00	
200.7	IRON (TOTAL)	40	U	ug/L	40	JAS	11/15/00	
200.7	MANGANESE (TOTAL)	5.0	U	ug/L	5.0	JAS	11/15/00	
200.7	NICKEL (TOTAL)	10	U	ug/L	10	JAS	11/15/00	
200.7	SILVER (TOTAL)	10	U	ug/L	10	JAS	11/15/00	
200.7	SODIUM (TOTAL)	400		mg/L	0.50	JAS	11/15/00	
200.7	ZINC (TOTAL)	20	U	ug/L	20	JAS	11/15/00	
<u>PRIORITY POLLUTANT PEST. AND PCB'S</u>								
608	ALDRIN	0.0050	U	ug/L	0.0050	TCZ	11/15/00	11/14/00
608	o-BHC	0.0050	U	ug/L	0.0050	TCZ	11/15/00	11/14/00
608	p-BHC	0.020	U	ug/L	0.020	TCZ	11/15/00	11/14/00
608	d-BHC	0.020	U	ug/L	0.020	TCZ	11/15/00	11/14/00
608	g-BHC (LINDANE)	0.020	U	ug/L	0.020	TCZ	11/15/00	11/14/00
608	CHLORDANE (tech.)	0.50	U	ug/L	0.50	TCZ	11/15/00	11/14/00
608	4,4'-DDD	0.020	U	ug/L	0.020	TCZ	11/15/00	11/14/00
608	4,4'-DDE	0.020	U	ug/L	0.020	TCZ	11/15/00	11/14/00
608	4,4'-DDT	0.020	U	ug/L	0.020	TCZ	11/15/00	11/14/00
608	DIFLDRIN	0.0050	U	ug/L	0.0050	TCZ	11/15/00	11/14/00
608	ENDOSULFAN I	0.020	U	ug/L	0.020	TCZ	11/15/00	11/14/00
608	ENDOSULFAN II	0.020	U	ug/L	0.020	TCZ	11/15/00	11/14/00
608	ENDOSULFAN SULFATE	0.020	U	ug/L	0.020	TCZ	11/15/00	11/14/00
608	ENDRIN	0.010	U	ug/L	0.010	TCZ	11/15/00	11/14/00
608	ENDRIN ALDEHYDE	0.020	U	ug/L	0.020	TCZ	11/15/00	11/14/00
608	HEPTACHLOR	0.020	U	ug/L	0.020	TCZ	11/15/00	11/14/00
608	HEPTACHLOR EPOXIDE	0.020	U	ug/L	0.020	TCZ	11/15/00	11/14/00
608	METHOXYCHLOR	0.020	U	ug/L	0.020	TCZ	11/15/00	11/14/00

MR. RICHARD MOULTON
 CITY OF FORT MYERS
 2751 JACKSONVILLE ST
 FORT MYERS, FL 33916



ANALYTICAL REPORT

Submission Number: 11000355 Client's P.O. Number:
 Date Received: 11/14/00 Project Number:
 Date Reported: 12/06/00 Project Name:
 Elab Report Name: Finalnew->Final2.RP1

Lab Sample Number: 0011355 1 Date Sampled: 11/13/00
 Client Sample Number: Sample Matrix: DRINKING WATER
 Sample Description: DEEP WELL#4

Method	Analyte	Result	Q	Units	Reporting Limit	Analyst	Date Analyzed	Prepared
<u>PRIORITY POLLUTANT PEST. AND PCB'S</u>								
608	TOXAPHENE	0.50	U	ug/L	0.50	TCZ	11/15/00	11/14/00
608	PCB 1016	0.50	U	ug/L	0.50	TCZ	11/15/00	11/14/00
608	PCB 1221	0.50	U	ug/L	0.50	TCZ	11/15/00	11/14/00
608	PCB 1232	0.50	U	ug/L	0.50	TCZ	11/15/00	11/14/00
608	PCB 1242	0.50	U	ug/L	0.50	TCZ	11/15/00	11/14/00
608	PCB 1248	0.50	U	ug/L	0.50	TCZ	11/15/00	11/14/00
608	PCB 1254	0.50	U	ug/L	0.50	TCZ	11/15/00	11/14/00
608	PCB 1260	0.50	U	ug/L	0.50	TCZ	11/15/00	11/14/00
<u>TRIALOMETHANES (THMS)</u>								
502.2	BROMODICHLOROMETHANE	0.00050	U	mg/L	0.00050	RME	11/21/00	
502.2	BROMOFORM	0.00050	U	mg/L	0.00050	RME	11/21/00	
502.2	CHLORODIBROMOMETHANE	0.00050	U	mg/L	0.00050	RME	11/21/00	
502.2	CHLOROFORM	0.00050	U	mg/L	0.00050	RME	11/21/00	
502.2	TOTAL TRIHALOMETHANES	0.00050	U	mg/L	0.00050	RME	11/21/00	
HACH	RESIDUAL CHLORINE	2.0	U	mg/L	2.0	RME	11/21/00	
<u>TRIALOMETHANES (THMS) - FP</u>								
330.2	RESIDUAL CHLORINE	2.0	U	mg/L	2.0	RME	11/26/00	
502.2	BROMODICHLOROMETHANE	0.024		mg/L	0.0025	RME	11/26/00	
502.2	BROMOFORM	0.063		mg/L	0.0025	RME	11/26/00	
502.2	CHLORODIBROMOMETHANE	0.070		mg/L	0.0025	RME	11/26/00	
502.2	CHLOROFORM	0.0055		mg/L	0.0025	RME	11/26/00	
502.2	TOTAL TRIHALOMETHANES (FP)	0.16		mg/L	0.0025	RME	11/26/00	
<u>PRIORITY POLLUTANT VOLATILE ORGANICS</u>								
624	ACROLEIN	20	U	ug/L	20	JSA	11/22/00	
624	ACRYLONITRILE	20	U	ug/L	20	JSA	11/22/00	
624	BENZENE	1.0	U	ug/L	1.0	JSA	11/22/00	
624	BROMODICHLOROMETHANE	1.0	U	ug/L	1.0	JSA	11/22/00	
624	BROMOFORM	1.0	U	ug/L	1.0	JSA	11/22/00	
624	BROMOMETHANE	1.0	U	ug/L	1.0	JSA	11/22/00	
624	CARBON TETRACHLORIDE	1.0	U	ug/L	1.0	JSA	11/22/00	
624	CHLOROBENZENE	1.0	U	ug/L	1.0	JSA	11/22/00	

MR. RICHARD MOULTON
 CITY OF FORT MYERS
 2751 JACKSONVILLE ST
 FORT MYERS, FL 33916



ANALYTICAL REPORT

Page 8

Submission Number: 11000355 Client's P.O. Number:
 Date Received: 11/14/00 Project Number:
 Date Reported: 12/06/00 Project Name:
 Elab Report Name: Finalnew->Final2.RP1

Lab Sample Number: 0011355 1 Date Sampled: 11/13/00
 Client Sample Number: Sample Matrix: DRINKING WATER
 Sample Description: DEEP WELL#4

Method	Analyte	Result	Q	Units	Reporting		Date Analyzed	Prepared
					Limit	Analyst		
<u>PRIORITY POLLUTANT VOLATILE ORGANICS</u>								
624	CHLOROETHANE	1.0	U	ug/L	1.0	JSA	11/22/00	
624	2-CHLOROETHYL VINYL ETHER	10	U	ug/L	10	JSA	11/22/00	
624	CHLOROFORM	1.0	U	ug/L	1.0	JSA	11/22/00	
624	CHLOROMETHANE	1.0	U	ug/L	1.0	JSA	11/22/00	
624	DIBROMOCHLOROMETHANE	1.0	U	ug/L	1.0	JSA	11/22/00	
624	1,2-DICHLOROBENZENE	1.0	U	ug/L	1.0	JSA	11/22/00	
624	1,3-DICHLOROBENZENE	1.0	U	ug/L	1.0	JSA	11/22/00	
624	1,4-DICHLOROBENZENE	1.0	U	ug/L	1.0	JSA	11/22/00	
624	1,1-DICHLOROETHANE	1.0	U	ug/L	1.0	JSA	11/22/00	
624	1,2-DICHLOROETHANE	1.0	U	ug/L	1.0	JSA	11/22/00	
624	1,1-DICHLOROETHENE	1.0	U	ug/L	1.0	JSA	11/22/00	
624	trans-1,2-DICHLOROETHENE	1.0	U	ug/L	1.0	JSA	11/22/00	
624	1,2-DICHLOROPROPANE	1.0	U	ug/L	1.0	JSA	11/22/00	
624	cis-1,3-DICHLOROPROPENE	5.0	U	ug/L	5.0	JSA	11/22/00	
624	trans-1,3-DICHLOROPROPENE	5.0	U	ug/L	5.0	JSA	11/22/00	
624	ETHYLBENZENE	1.0	U	ug/L	1.0	JSA	11/22/00	
624	METHYLENE CHLORIDE	5.0	U	ug/L	5.0	JSA	11/22/00	
624	1,1,2,2-TETRACHLOROETHANE	1.0	U	ug/L	1.0	JSA	11/22/00	
624	TETRACHLOROETHENE	1.0	U	ug/L	1.0	JSA	11/22/00	
624	TOLUENE	1.0	U	ug/L	1.0	JSA	11/22/00	
624	1,1,1-TRICHLOROETHANE	1.0	U	ug/L	1.0	JSA	11/22/00	
624	1,1,2-TRICHLOROETHANE	1.0	U	ug/L	1.0	JSA	11/22/00	
624	TRICHLOROETHENE	1.0	U	ug/L	1.0	JSA	11/22/00	
624	TRICHLOROFLUOROMETHANE	1.0	U	ug/L	1.0	JSA	11/22/00	
624	VINYL CHLORIDE	1.0	U	ug/L	1.0	JSA	11/22/00	

Data Qualifier Code Key:

U - The analyte was analyzed for, but was not detected above the reported sample quantitation limit.

MR. RICHARD MOULTON
CITY OF FORT MYERS
2751 JACKSONVILLE ST
FORT MYERS, FL 33916



ANALYTICAL REPORT

Page 9

Submission Number: 11000355
Date Received: 11/14/00
Date Reported: 12/06/00

Client's P.O. Number:
Project Number:
Project Name:
Elab Report Name: Finalnow->Final2.RP1

CERTIFICATION: All analytical data reported above were obtained using the specified methods and were validated by our laboratory quality control system. This laboratory follows an approved quality assurance program.

Respectfully submitted:

A handwritten signature in black ink, appearing to read 'Paul K. Canevaro', is written over a horizontal line.

Paul K. Canevaro
Laboratory Director

APPENDIX J.3

Well P-5 Ambient Water Quality Results

MR. RICHARD MOULTON
 CITY OF FORT MYERS
 2751 JACKSONVILLE ST
 FORT MYERS, FL 33916



ANALYTICAL REPORT

Submission Number: 12000151
 Date Received: 12/06/00
 Date Reported: 01/11/01

Client's P.O. Number: **P-5**
 Project Number:
 Project Name:
 Elab Report Name: Finalnew->Final2.RP1

Lab Sample Number: 0012151 1
 Client Sample Number:
 Sample Description: DEEP WELL #5

Date Sampled: 12/05/00
 Sample Matrix: GROUND WATER

Method	Analyte	Result	Q	Units	Reporting Limit	Analyst	Date Analyzed	Prepared
<u>PRIORITY POLLUTANT B/N/A EXTRACTABLES</u>								
625	ACENAPHTHENE	5.0	U	ug/L	5.0	VG	12/14/00	12/08/00
625	ACENAPHTHYLENE	5.0	U	ug/L	5.0	VG	12/14/00	12/08/00
625	ANTHRACENE	5.0	U	ug/L	5.0	VG	12/14/00	12/08/00
625	BENZIDINE	25	U	ug/L	25	VG	12/14/00	12/08/00
625	BENZ(A)ANTHRACENE	5.0	U	ug/L	5.0	VG	12/14/00	12/08/00
625	BENZO(B)FLUORANTHENE	5.0	U	ug/L	5.0	VG	12/14/00	12/08/00
625	BENZO(K)FLUORANTHENE	5.0	U	ug/L	5.0	VG	12/14/00	12/08/00
625	BENZO(G,H,I)PERYLENE	5.0	U	ug/L	5.0	VG	12/14/00	12/08/00
625	BENZO(A)PYRENE	5.0	U	ug/L	5.0	VG	12/14/00	12/08/00
625	BIS(2-CHLOROETHOXY) METHANE	5.0	U	ug/L	5.0	VG	12/14/00	12/08/00
625	BIS(2-CHLOROETHYL) ETHER	5.0	U	ug/L	5.0	VG	12/14/00	12/08/00
625	BIS(2-CHLOROISOPROPYL) ETHER	5.0	U	ug/L	5.0	VG	12/14/00	12/08/00
625	BIS(2-ETHYLHEXYL) PHTHALATE	5.0	U	ug/L	5.0	VG	12/14/00	12/08/00
625	4-BROMOPHENYL PHENYL ETHER	5.0	U	ug/L	5.0	VG	12/14/00	12/08/00
625	BUTYL BENZYL PHTHALATE	5.0	U	ug/L	5.0	VG	12/14/00	12/08/00
625	2-CHLORONAPHTHALENE	5.0	U	ug/L	5.0	VG	12/14/00	12/08/00
625	4-CHLORO-3-METHYLPHENOL	20	U	ug/L	20	VG	12/14/00	12/08/00
625	2-CHLOROPHENOL	5.0	U	ug/L	5.0	VG	12/14/00	12/08/00
625	4-CHLOROPHENYL PHENYL ETHER	5.0	U	ug/L	5.0	VG	12/14/00	12/08/00
625	CHRYSENE	5.0	U	ug/L	5.0	VG	12/14/00	12/08/00
625	DIBENZO(A,H)ANTHRACENE	5.0	U	ug/L	5.0	VG	12/14/00	12/08/00
625	DI-N-BUTYLPHTHALATE	5.0	U	ug/L	5.0	VG	12/14/00	12/08/00
625	1,2-DICHLOROBENZENE	5.0	U	ug/L	5.0	VG	12/14/00	12/08/00
625	1,3-DICHLOROBENZENE	5.0	U	ug/L	5.0	VG	12/14/00	12/08/00
625	1,4-DICHLOROBENZENE	5.0	U	ug/L	5.0	VG	12/14/00	12/08/00
625	3,3'-DICHLOROBENZIDINE	20	U	ug/L	20	VG	12/14/00	12/08/00
625	2,4-DICHLOROPHENOL	5.0	U	ug/L	5.0	VG	12/14/00	12/08/00
625	DIETHYLPHTHALATE	5.0	U	ug/L	5.0	VG	12/14/00	12/08/00
625	2,4-DIMETHYLPHENOL	5.0	U	ug/L	5.0	VG	12/14/00	12/08/00
625	DIMETHYLPHTHALATE	5.0	U	ug/L	5.0	VG	12/14/00	12/08/00
625	4,6-DINITRO-2-METHYLPHENOL	20	U	ug/L	20	VG	12/14/00	12/08/00

MR. RICHARD MOULTON
 CITY OF FORT MYERS
 2751 JACKSONVILLE ST
 FORT MYERS, FL 33916



ANALYTICAL REPORT

Submission Number: 12000151
 Date Received: 12/06/00
 Date Reported: 01/11/01

Client's P.O. Number:
 Project Number:
 Project Name:
 Elab Report Name: Finalnew->Final2.RP1

Lab Sample Number: 0012151 1
 Client Sample Number:
 Sample Description: DEEP WELL #5

Date Sampled: 12/05/00
 Sample Matrix: GROUND WATER

Method	Analyte	Result	Q	Units	Limit	Analyst	Date Analyzed	Prepared
<u>PRIORITY POLLUTANT B/M/A EXTRACTABLES</u>								
625	2,4-DINITROPHENOL	20	U	ug/L	20	VG	12/14/00	12/08/00
625	2,4-DINITROTOLUENE	5.0	U	ug/L	5.0	VG	12/14/00	12/08/00
625	2,6-DINITROTOLUENE	5.0	U	ug/L	5.0	VG	12/14/00	12/08/00
625	1,2-DIPHENYLHYDRAZINE	5.0	U	ug/L	5.0	VG	12/14/00	12/08/00
625	DI-n-OCTYLPHTHALATE	5.0	U	ug/L	5.0	VG	12/14/00	12/08/00
625	DIOXIN (2,3,7,8-TCDD) (SCREEN)	100	U	ug/L	100	VG	12/14/00	12/08/00
625	FLUORANTHENE	5.0	U	ug/L	5.0	VG	12/14/00	12/08/00
625	FLUORENE	5.0	U	ug/L	5.0	VG	12/14/00	12/08/00
625	HEXACHLOROBENZENE	5.0	U	ug/L	5.0	VG	12/14/00	12/08/00
625	HEXACHLOROBUTADIENE	5.0	U	ug/L	5.0	VG	12/14/00	12/08/00
625	HEXACHLOROCYCLOPENTADIENE	5.0	U	ug/L	5.0	VG	12/14/00	12/08/00
625	HEXACHLOROETHANE	5.0	U	ug/L	5.0	VG	12/14/00	12/08/00
625	INDENO(1,2,3-CD)PYRENE	5.0	U	ug/L	5.0	VG	12/14/00	12/08/00
625	ISOPHORONE	5.0	U	ug/L	5.0	VG	12/14/00	12/08/00
625	NAPHTHALENE	5.0	U	ug/L	5.0	VG	12/14/00	12/08/00
625	NITROBENZENE	5.0	U	ug/L	5.0	VG	12/14/00	12/08/00
625	2-NITROPHENOL	5.0	U	ug/L	5.0	VG	12/14/00	12/08/00
625	4-NITROPHENOL	20	U	ug/L	20	VG	12/14/00	12/08/00
625	N-NITROSODIMETHYLAMINE	5.0	U	ug/L	5.0	VG	12/14/00	12/08/00
625	N-NITROSODIPHENYLAMINE	5.0	U	ug/L	5.0	VG	12/14/00	12/08/00
625	N-NITROSODI-n-PROPYLAMINE	5.0	U	ug/L	5.0	VG	12/14/00	12/08/00
625	PENTACHLOROPHENOL	20	U	ug/L	20	VG	12/14/00	12/08/00
625	PHENANTHRENE	5.0	U	ug/L	5.0	VG	12/14/00	12/08/00
625	PHENOL	5.0	U	ug/L	5.0	VG	12/14/00	12/08/00
625	PYRENE	5.0	U	ug/L	5.0	VG	12/14/00	12/08/00
625	1,2,4-TRICHLOROBENZENE	5.0	U	ug/L	5.0	VG	12/14/00	12/08/00
625	2,4,6-TRICHLOROPHENOL	5.0	U	ug/L	5.0	VG	12/14/00	12/08/00
<u>DRINKING WATER REQ. VOLATILE ORGANICS</u>								
502.2	BENZENE	0.50	U	ug/L	0.50	RME	12/13/00	
502.2	CARBON TETRACHLORIDE	0.50	U	ug/L	0.50	RME	12/13/00	
502.2	o-DICHLOROBENZENE	0.50	U	ug/L	0.50	RME	12/13/00	

MR. RICHARD MOULTON
 CITY OF FORT MYERS
 2751 JACKSONVILLE ST
 FORT MYERS, FL 33916



ANALYTICAL REPORT

Submission Number: 12000151 Client's P.O. Number:
 Date Received: 12/06/00 Project Number:
 Date Reported: 01/11/01 Project Name:
 Elab Report Name: Finalnew->Final2.RP1

Lab Sample Number: 0012151 1 Date Sampled: 12/05/00
 Client Sample Number:
 Sample Description: DNEP WELL #5 Sample Matrix: GROUND WATER

Method	Analyte	Result	Q	Units	Limit	Reporting Analyst	Date Analyzed	Prepared
DRINKING WATER REG. VOLATILE ORGANICS								
502.2	p-DICHLOROBENZENE	0.50	U	ug/L	0.50	RME	12/13/00	
502.2	1,2-DICHLOROETHANE	0.50	U	ug/L	0.50	RME	12/13/00	
502.2	1,1-DICHLOROETHENE	0.50	U	ug/L	0.50	RME	12/13/00	
502.2	cis-1,2-DICHLOROETHYLENE	0.50	U	ug/L	0.50	RME	12/13/00	
502.2	trans-1,2-DICHLOROETHYLENE	0.50	U	ug/L	0.50	RME	12/13/00	
502.2	DICHLOROMETHANE	0.50	U	ug/L	0.50	RME	12/13/00	
502.2	1,2-DICHLOROPROPANE	0.50	U	ug/L	0.50	RME	12/13/00	
502.2	ETHYLBENZENE	0.50	U	ug/L	0.50	RME	12/13/00	
502.2	MONOCHLOROBENZENE	0.50	U	ug/L	0.50	RME	12/13/00	
502.2	STYRENE	0.50	U	ug/L	0.50	RME	12/13/00	
502.2	TETRACHLOROETHYLENE	0.50	U	ug/L	0.50	RME	12/13/00	
502.2	TOLUENE	0.50	U	ug/L	0.50	RME	12/13/00	
502.2	1,2,4-TRICHLOROBENZENE	0.50	U	ug/L	0.50	RME	12/13/00	
502.2	1,1,1-TRICHLOROETHANE	0.50	U	ug/L	0.50	RME	12/13/00	
502.2	1,1,2-TRICHLOROETHANE	0.50	U	ug/L	0.50	RME	12/13/00	
502.2	TRICHLOROETHYLENE	0.50	U	ug/L	0.50	RME	12/13/00	
502.2	VINYL CHLORIDE	0.50	U	ug/L	0.50	RME	12/13/00	
502.2	XYLENES (Total)	0.50	U	ug/L	0.50	RME	12/13/00	
DM CHLORINATED PESTICIDES & PCB								
505	ALACHLOR	1.5	U	ug/L	1.5	TCZ	12/08/00	12/07/00
505	ATRAZINE	2.5	U	ug/L	2.5	TCZ	12/08/00	12/07/00
505	g-BHC (LINDANE)	0.010	U	ug/L	0.010	TCZ	12/08/00	12/07/00
505	CHLORDANE	0.020	U	ug/L	0.020	TCZ	12/08/00	12/07/00
505	ENDRIN	0.010	U	ug/L	0.010	TCZ	12/08/00	12/07/00
505	HEPTACHLOR	0.030	U	ug/L	0.030	TCZ	12/08/00	12/07/00
505	HEPTACHLOR EPOXIDE	0.010	U	ug/L	0.010	TCZ	12/08/00	12/07/00
505	HEXACHLOROBENZENE	0.10	U	ug/L	0.10	TCZ	12/08/00	12/07/00
505	HEXACHLOROCYCLOPENTADIENE	0.10	U	ug/L	0.10	TCZ	12/08/00	12/07/00
505	METHOXYCHLOR	0.050	U	ug/L	0.050	TCZ	12/08/00	12/07/00
505	SIMAZINE	1.5	U	ug/L	1.5	TCZ	12/08/00	12/07/00
505	TOXAPHENE	0.18	U	ug/L	0.18	TCZ	12/08/00	12/07/00

MR. RICHARD MOULTON
 CITY OF FORT MYERS
 2751 JACKSONVILLE ST
 FORT MYERS, FL 33916



ANALYTICAL REPORT

Submission Number: 12000151 Client's P.O. Number:
 Date Received: 12/06/00 Project Number:
 Date Reported: 01/11/01 Project Name:
 Elab Report Name: Finalnew->Final2.RP1

Lab Sample Number: 0012151 1 Date Sampled: 12/05/00
 Client Sample Number: Sample Matrix: GROUND WATER
 Sample Description: DEEP WELL #5

Method	Analyte	Result	Q	Units	Reporting Limit	Analyst	Date Analyzed	Prepared
<u>DW CHLORINATED PESTICIDES & PCB</u>								
505	PCB 1016	0.10	U	ug/L	0.10	TCZ	12/08/00	12/07/00
505	PCB 1221	0.10	U	ug/L	0.10	TCZ	12/08/00	12/07/00
505	PCB 1232	0.10	U	ug/L	0.10	TCZ	12/08/00	12/07/00
505	PCB 1242	0.10	U	ug/L	0.10	TCZ	12/08/00	12/07/00
505	PCB 1248	0.10	U	ug/L	0.10	TCZ	12/08/00	12/07/00
505	PCB 1254	0.10	U	ug/L	0.10	TCZ	12/08/00	12/07/00
505	PCB 1260	0.10	U	ug/L	0.10	TCZ	12/08/00	12/07/00
505	TOTAL PCB'S	0.10	U	ug/L	0.10	TCZ	12/08/00	12/07/00
<u>DRINKING WATER ORGANIC HERBICIDES</u>								
515.1	2,4-D	0.10	U	ug/L	0.10	OAO	12/09/00	12/07/00
515.1	DALAPON	1.0	U	ug/L	1.0	OAO	12/09/00	12/07/00
515.1	DINoseb	0.20	U	ug/L	0.20	OAO	12/09/00	12/07/00
515.1	PENTACHLOROPHENOL	0.040	U	ug/L	0.040	OAO	12/09/00	12/07/00
515.1	PICLORAM	0.10	U	ug/L	0.10	OAO	12/09/00	12/07/00
515.1	2,4,5-TP (SILVEX)	0.20	U	ug/L	0.20	OAO	12/09/00	12/07/00
<u>DRINKING WATER ORGANIC CARBAMATES</u>								
531.1	CARBOFURAN	2.0	U	ug/L	2.0	KHA	12/12/00	12/11/00
531.1	OXAMYL (VYDATE)	2.0	U	ug/L	2.0	KHA	12/12/00	12/11/00
<u>DW DISINFECTANT BY-PRODUCTS</u>								
	1,2-DIBROMO-3-CHLOROPROPANE	0.020	U	ug/L	0.020	OAO	12/10/00	12/09/00
	ETHYLENE DIBROMIDE	0.010	U	ug/L	0.010	OAO	12/10/00	12/09/00
<u>DW MISC. SOC'S - GLYPHOSATE</u>								
547	GLYPHOSATE	6.0	U	ug/L	6.0	KHA	12/09/00	12/07/00
<u>DW MISC. SOC'S - ENDOTHALL</u>								
548.1	ENDOTHALL	9.0	U	ug/L	9.0	TKA	12/08/00	12/07/00
<u>DW MISC. SOC'S - DIQUAT</u>								
549.1	DIQUAT	0.40	U	ug/L	0.40	KHA	12/14/00	12/07/00
<u>DW ADIPATES, PHTHALATES, AND PAH'S</u>								
525.2	BENZO(A)PYRENE	0.10	U	ug/L	0.10	TKA	12/09/00	12/07/00
525.2	DI(2-ETHYLHEXYL)PHTHALATE	2.0	U	ug/L	2.0	TKA	12/09/00	12/07/00
525.2	DI(2-ETHYLHEXYL)ADIPATE	1.6	U	ug/L	1.6	TKA	12/09/00	12/07/00

MR. RICHARD MOULTON
 CITY OF FORT MYERS
 2751 JACKSONVILLE ST
 FORT MYERS, FL 33916



ANALYTICAL REPORT

Submission Number: 12000191 Client's P.O. Number:
 Date Received: 12/06/00 Project Number:
 Date Reported: 01/11/01 Project Name:
 Elab Report Name: Finalnew->Final2.RP1

Lab Sample Number: 0012151 1 Date Sampled: 12/05/00
 Client Sample Number: Sample Matrix: GROUND WATER
 Sample Description: DEEP WELL #5

Method	Analyte	Result	Q	Units	Limit	Reporting Analyst	Date Analyzed	Prepared
110.2	COLOR	5.0	U	UNIT	5.0	MRO	12/06/00	12:20
120.1	SPECIFIC CONDUCTANCE	3530		umhos/cm	1.0	MRO	12/06/00	
140.1	ODOR	6.0		TON	5.0	MRO	12/06/00	12:17
150.1	pH	7.31		UNIT		MRO	12/06/00	17:20
160.1	TOTAL DISSOLVED SOLIDS (TDS)	2000		mg/L	5.0	MRO	12/07/00	
335.2	CYANIDE - TOTAL	0.010	U	mg/L	0.010	TPE	12/11/00	
353.2	NITRATE NITROGEN (as N)	0.050	U	mg/L	0.050	TPE	12/06/00	
353.2	NITRITE NITROGEN (as N)	0.050	U	mg/L	0.050	TPE	12/06/00	
370.1	DISSOLVED SILICA	16		mg/L	1.0	KFE	12/11/00	
310.1	HYDROXIDE ALK. as CaCO3	5.0	U	mg/L	5.0	MMA	12/08/00	
350.1	AMMONIA NITROGEN (as N)	0.62		mg/L	0.050	TPE	12/07/00	
415.1	TOTAL ORGANIC CARBON (TOC)	1.0	U	mg/L	1.0	MMA	12/07/00	
425.1	SURFACTANTS (MBAS)	0.10	U	mg/L	0.10	MMA	12/06/00	20:00
900.0	GROSS ALPHA	9.2+/-3.7		pCi/L		MJN	12/04/00	
SM7500Ra	RADIUM 226			pCi/L				
SM7500Ra	RADIUM 228			pCi/L				
300.0	CHLORIDE	880		mg/L	2.5	RFI	12/06/00	
300.0	FLUORIDE	1.6		mg/L	0.75	RFI	12/07/00	
300.0	SULFATE	320		mg/L	7.5	RFI	12/06/00	
204.2	ANTIMONY (TOTAL)	3.0	U	ug/L	3.0	EM	12/08/00	
7421	LEAD (TOTAL)	2.0	U	ug/L	2.0	EM	12/08/00	
7470	MERCURY	0.20	U	ug/L	0.20	JAS	12/08/00	
7740	SELENIUM (TOTAL)	2.0	U	ug/L	2.0	JAS	12/12/00	
7841	THALLIUM (TOTAL)	1.0	U	ug/L	1.0	EM	12/12/00	
200.7	STRONTIUM (TOTAL)	17000		ug/L	100	JAS	12/12/00	
200.7	ALUMINUM (TOTAL)	100	U	ug/L	100	EM	12/11/00	
200.7	ARSENIC (TOTAL)	5.0	U	ug/L	5.0	EM	12/11/00	
200.7	BARIUM (TOTAL)	24		ug/L	10	EM	12/11/00	
200.7	BERYLLIUM (TOTAL)	1.0	U	ug/L	1.0	EM	12/11/00	
200.7	CADMIUM (TOTAL)	1.0	U	ug/L	1.0	EM	12/11/00	
200.7	CALCIUM (TOTAL)	99		mg/L	0.50	EM	12/11/00	
200.7	CHROMIUM (TOTAL)	5.0	U	ug/L	5.0	EM	12/11/00	

MR. RICHARD MOULTON
 CITY OF FORT MYERS
 2751 JACKSONVILLE ST
 FORT MYERS, FL 33916



ANALYTICAL REPORT

Submission Number: 12000151 Client's P.O. Number:
 Date Received: 12/06/00 Project Number:
 Date Reported: 01/12/01 Project Name:
 Elab Report Name: Finalnew->Final2.RP1

Lab Sample Number: 0012151 1 Date Sampled: 12/05/00
 Client Sample Number:
 Sample Description: DEEP WELL #5 Sample Matrix: GROUND WATER

Method	Analyte	Result	Q	Units	Reporting		Date Analyzed	Prepared
					Limit	Analyst		
200.7	COPPER (TOTAL)	10	U	ug/L	10	EM	12/11/00	
200.7	IRON (TOTAL)	40	U	ug/L	40	EM	12/11/00	
200.7	MAGNESIUM (TOTAL)	87		mg/L	0.50	EM	12/11/00	
200.7	MANGANESE (TOTAL)	5.0	U	ug/L	5.0	EM	12/11/00	
200.7	NICKEL (TOTAL)	10	U	ug/L	10	EM	12/11/00	
200.7	SILVER (TOTAL)	10	U	ug/L	10	EM	12/11/00	
200.7	SODIUM (TOTAL)	410		mg/L	0.50	EM	12/11/00	
200.7	ZINC (TOTAL)	20	U	ug/L	20	EM	12/11/00	
<u>PRIORITY POLLUTANT PEST. AND PCB'S</u>								
608	ALDRIN	0.0056	U	ug/L	0.0056	TCZ	12/08/00	12/07/00
608	a-BHC	0.0056	U	ug/L	0.0056	TCZ	12/08/00	12/07/00
608	b-BHC	0.022	U	ug/L	0.022	TCZ	12/08/00	12/07/00
608	d-BHC	0.022	U	ug/L	0.022	TCZ	12/08/00	12/07/00
608	g-BHC (LINDANE)	0.022	U	ug/L	0.022	TCZ	12/08/00	12/07/00
608	CHLORDANE (tech.)	0.56	U	ug/L	0.56	TCZ	12/08/00	12/07/00
608	4,4'-DDD	0.022	U	ug/L	0.022	TCZ	12/08/00	12/07/00
608	4,4'-DDE	0.022	U	ug/L	0.022	TCZ	12/08/00	12/07/00
608	4,4'-DDT	0.022	U	ug/L	0.022	TCZ	12/08/00	12/07/00
608	DIELDRIN	0.0056	U	ug/L	0.0056	TCZ	12/08/00	12/07/00
608	ENDOSULFAN I	0.022	U	ug/L	0.022	TCZ	12/08/00	12/07/00
608	ENDOSULFAN II	0.022	U	ug/L	0.022	TCZ	12/08/00	12/07/00
608	ENDOSULFAN SULFATE	0.022	U	ug/L	0.022	TCZ	12/08/00	12/07/00
608	ENDRIN	0.022	U	ug/L	0.022	TCZ	12/08/00	12/07/00
608	ENDRIN ALDEHYDE	0.022	U	ug/L	0.022	TCZ	12/08/00	12/07/00
608	HEPTACHLOR	0.022	U	ug/L	0.022	TCZ	12/08/00	12/07/00
608	HEPTACHLOR EPOXIDE	0.022	U	ug/L	0.022	TCZ	12/08/00	12/07/00
608	METHOXYCHLOR	0.022	U	ug/L	0.022	TCZ	12/08/00	12/07/00
608	TOXAPHENE	0.56	U	ug/L	0.56	TCZ	12/08/00	12/07/00
608	PCB 1016	0.56	U	ug/L	0.56	TCZ	12/08/00	12/07/00
608	PCB 1221	0.56	U	ug/L	0.56	TCZ	12/08/00	12/07/00
608	PCB 1232	0.56	U	ug/L	0.56	TCZ	12/08/00	12/07/00
608	PCB 1242	0.56	U	ug/L	0.56	TCZ	12/08/00	12/07/00

MR. RICHARD MOULTON
 CITY OF FORT MYERS
 2751 JACKSONVILLE ST
 FORT MYERS, FL 33916



ANALYTICAL REPORT

Submission Number: 12000151 Client's P.O. Number:
 Date Received: 12/06/00 Project Number:
 Date Reported: 01/11/01 Project Name:
 Elab Report Name: Finalnew->Final2.RP1

Lab Sample Number: 0012151 1 Date Sampled: 12/05/00
 Client Sample Number: Sample Matrix: GROUND WATER
 Sample Description: DEEP WELL #5

Method	Analyte	Result	Q	Units	Reporting		Date Analyzed	Prepared
					Limit	Analyst		
<u>PRIORITY POLLUTANT PBST. AND PCB'S</u>								
608	PCB 1248	0.56	U	ug/L	0.56	TCZ	12/08/00	12/07/00
608	PCB 1254	0.56	U	ug/L	0.56	TCZ	12/08/00	12/07/00
608	PCB 1260	0.56	U	ug/L	0.56	TCZ	12/08/00	12/07/00
<u>PRIORITY POLLUTANT VOLATILE ORGANICS</u>								
624	ACROLEIN	1.0	U	ug/L	1.0	JSA	12/15/00	
624	ACRYLONITRILE	1.0	U	ug/L	1.0	JSA	12/15/00	
624	BENZENE	1.0	U	ug/L	1.0	JSA	12/15/00	
624	BROMODICHLOROMETHANE	0.60	U	ug/L	0.60	JBA	12/15/00	
624	BROMOFORM	1.0	U	ug/L	1.0	JBA	12/15/00	
624	BROMOMETHANE	1.0	U	ug/L	1.0	JBA	12/15/00	
624	CARBON TETRACHLORIDE	1.0	U	ug/L	1.0	JBA	12/15/00	
624	CHLOROETHANE	1.0	U	ug/L	1.0	JBA	12/15/00	
624	CHLOROBENZENE	1.0	U	ug/L	1.0	JBA	12/15/00	
624	CHLOROETHANE	1.0	U	ug/L	1.0	JBA	12/15/00	
624	2-CHLOROETHYL VINYL ETHER	1.0	U	ug/L	1.0	JBA	12/15/00	
624	CHLOROFORM	1.0	U	ug/L	1.0	JBA	12/15/00	
624	CHLOROMETHANE	1.0	U	ug/L	1.0	JSA	12/15/00	
624	DIBROMOCHLOROMETHANE	0.40	U	ug/L	0.40	JBA	12/15/00	
624	1,2-DICHLOROBENZENE	1.0	U	ug/L	1.0	JSA	12/15/00	
624	1,3-DICHLOROBENZENE	1.0	U	ug/L	1.0	JBA	12/15/00	
624	1,4-DICHLOROBENZENE	1.0	U	ug/L	1.0	JBA	12/15/00	
624	1,1-DICHLOROETHANE	1.0	U	ug/L	1.0	JSA	12/15/00	
624	1,2-DICHLOROETHANE	1.0	U	ug/L	1.0	JSA	12/15/00	
624	1,1-DICHLOROETHENE	1.0	U	ug/L	1.0	JSA	12/15/00	
624	trans-1,2-DICHLOROETHENE	1.0	U	ug/L	1.0	JSA	12/15/00	
624	1,2-DICHLOROPROPANE	1.0	U	ug/L	1.0	JBA	12/15/00	
624	cis-1,3-DICHLOROPROPENE	0.20	U	ug/L	0.20	JSA	12/15/00	
624	trans-1,3-DICHLOROPROPENE	0.20	U	ug/L	0.20	JBA	12/15/00	
624	ETHYLBENZENE	1.0	U	ug/L	1.0	JSA	12/15/00	
624	METHYLENE CHLORIDE	5.0	U	ug/L	5.0	JSA	12/15/00	
624	1,1,2,2-TETRACHLOROETHANE	0.20	U	ug/L	0.20	JSA	12/15/00	
624	TETRACHLOROETHENE	1.0	U	ug/L	1.0	JSA	12/15/00	

MR RICHARD MOULTON
CITY OF FORT MYERS
2751 JACKSONVILLE ST
FORT MYERS, FL 33916



ANALYTICAL REPORT

Page 6

Submission Number: 12000151 Client's P.O. Number:
Date Received: 12/06/00 Project Number:
Date Reported: 01/11/01 Project Name:
Elab Report Name: Finalnew->Final2.RP1

Lab Sample Number: 0012151 1 Date Sampled: 12/05/00
Client Sample Number: Sample Matrix: GROUND WATER
Sample Description: DEER WELL #5

Method	Analyte	Result	Q	Units	Reporting Limit	Analyst	Date Analyzed	Prepared
<u>PRIORITY POLLUTANT VOLATILE ORGANICS</u>								
624	TOLUENE	1.0	U	ug/L	1.0	JSA	12/15/00	
624	1,1,1-TRICHLOROETHANE	1.0	U	ug/L	1.0	JSA	12/15/00	
624	1,1,2-TRICHLOROETHANE	1.0	U	ug/L	1.0	JSA	12/15/00	
624	TRICHLOROETHENE	1.0	U	ug/L	1.0	JSA	12/15/00	
624	TRICHLOROFLUOROMETHANE	1.0	U	ug/L	1.0	JSA	12/15/00	
624	VINYL CHLORIDE	1.0	U	ug/L	1.0	JSA	12/15/00	

Data Qualifier Code Key:

U - The analyte was analyzed for, but was not detected above the reported sample quantitation limit.

CERTIFICATION: All analytical data reported above were obtained using the specified methods and were validated by our laboratory quality control system. This laboratory follows an approved quality assurance program.

Respectfully submitted:

Paul K. Canevaro
Laboratory Director

APPENDIX J.4

Well P-6 Ambient Water Quality Results

MR. RICHARD MOULTON
CITY OF FORT MYERS
2751 JACKSONVILLE ST
FORT MYERS, FL 33916

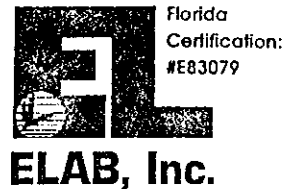

ANALYTICAL REPORT

Page 1

Submission Number: 10000531 Client's P.O. Number:
Date Received: 10/24/00 Project Number:
Date Reported: 12/04/00 Project Name:
Elab Report Name: Finalnew->Final2.RP1

Lab Sample Number: 0010531 1 Date Sampled: 10/23/00
Client Sample Number: Sample Matrix: DRINKING WATER
Sample Description: DEEP WELL (P 6)

Method	Analyte	Result	Q	Units	Limit	Reporting Analyst	Date Analyzed	Prepared
PRIORITY POLLUTANT B/N/A EXTRACTABLES								
625	ACENAPHTHENE	5.0	U	ug/L	5.0	TKA	11/03/00	10/30/00
625	ACENAPHTHYLENE	5.0	U	ug/L	5.0	TKA	11/03/00	10/30/00
625	ANTHRACENE	5.0	U	ug/L	5.0	TKA	11/03/00	10/30/00
625	BENZIDINE	25	U	ug/L	25	TKA	11/03/00	10/30/00
625	BENZ(A)ANTHRACENE	5.0	U	ug/L	5.0	TKA	11/03/00	10/20/00
625	BENZO(B)FLUORANTHENE	5.0	U	ug/L	5.0	TKA	11/03/00	10/30/00
625	BENZO(K)FLUORANTHENE	5.0	U	ug/L	5.0	TKA	11/03/00	10/30/00
625	BENZO(G,H,I)PERYLENE	5.0	U	ug/L	5.0	TKA	11/03/00	10/30/00
625	BENZO(A)PYRENE	5.0	U	ug/L	5.0	TKA	11/03/00	10/30/00
625	BIS(2-CHLOROETHOXY) METHANE	5.0	U	ug/L	5.0	TKA	11/03/00	10/30/00
625	BIS(2-CHLOROETHYL) ETHER	5.0	U	ug/L	5.0	TKA	11/03/00	10/30/00
625	BIS(2-CHLOROISOPROPYL) ETHER	5.0	U	ug/L	5.0	TKA	11/03/00	10/30/00
625	BIS(2-ETHYLHEXYL) PHTHALATE	5.0	U	ug/L	5.0	TKA	11/03/00	10/30/00
625	4-BROMOPHENYL PHENYL ETHER	5.0	U	ug/L	5.0	TKA	11/03/00	10/30/00
625	BUTYL BENZYL PHTHALATE	5.0	U	ug/L	5.0	TKA	11/03/00	10/30/00
625	2-CHLORONAPHTHALENE	5.0	U	ug/L	5.0	TKA	11/03/00	10/30/00
625	4-CHLORO-3-METHYLPHENOL	20	U	ug/L	20	TKA	11/03/00	10/30/00
625	2-CHLOROPHENOL	5.0	U	ug/L	5.0	TKA	11/03/00	10/30/00
625	4-CHLOROPHENYL PHENYL ETHER	5.0	U	ug/L	5.0	TKA	11/03/00	10/30/00
625	CHRYSENE	5.0	U	ug/L	5.0	TKA	11/03/00	10/30/00
625	DIBENZO(A,H)ANTHRACENE	5.0	U	ug/L	5.0	TKA	11/03/00	10/30/00
625	DI-n-BUTYLPHTHALATE	5.0	U	ug/L	5.0	TKA	11/03/00	10/30/00
625	1,2-DICHLOROBENZENE	5.0	U	ug/L	5.0	TKA	11/03/00	10/30/00
625	1,3-DICHLOROBENZENE	5.0	U	ug/L	5.0	TKA	11/03/00	10/30/00
625	1,4-DICHLOROBENZENE	5.0	U	ug/L	5.0	TKA	11/03/00	10/30/00
625	3,3'-DICHLOROBENZIDINE	20	U	ug/L	20	TKA	11/03/00	10/30/00
625	2,4-DICHLOROPHENOL	5.0	U	ug/L	5.0	TKA	11/03/00	10/30/00
625	DIETHYLPHTHALATE	5.0	U	ug/L	5.0	TKA	11/03/00	10/30/00
625	2,4-DIMETHYLPHENOL	5.0	U	ug/L	5.0	TKA	11/03/00	10/30/00
625	DIMETHYLPHTHALATE	5.0	U	ug/L	5.0	TKA	11/03/00	10/30/00
625	4,6-DINITRO-2-METHYLPHENOL	20	U	ug/L	20	TKA	11/03/00	10/30/00

MR. RICHARD MOULTON
 CITY OF FORT MYERS
 2751 JACKSONVILLE ST
 FORT MYERS, FL 33916



ANALYTICAL REPORT

Submission Number: 10000531 Client's P.O. Number:
 Date Received: 10/24/00 Project Number:
 Date Reported: 12/04/00 Project Name:
 Elab Report Name: Finalnew->Final2.RP1

Lab Sample Number: 0010531 1 Date Sampled: 10/23/00
 Client Sample Number:
 Sample Matrix: DRINKING WATER
 Sample Description: DEEP WELL (P 6)

Method	Analyte	Result	Q	Units	Reporting Limit	Analyst	Date Analyzed	Prepared
<u>PRIORITY POLLUTANT B/N/A EXTRACTABLES</u>								
625	2,4-DINITROPHENOL	20	U	ug/L	20	TKA	11/03/00	10/30/00
625	2,4-DINITROTOLUENE	5.0	U	ug/L	5.0	TKA	11/03/00	10/30/00
625	2,6-DINITROTOLUENE	5.0	U	ug/L	5.0	TKA	11/03/00	10/30/00
625	1,2-DIPHENYLHYDRAZINE	5.0	U	ug/L	5.0	TKA	11/03/00	10/30/00
625	DI-n-OCTYLPHTHALATE	5.0	U	ug/L	5.0	TKA	11/03/00	10/30/00
625	DIOXIN (2,3,7,8-TCDD) (SCREEN)	100	U	ug/L	100	TKA	11/03/00	10/30/00
625	FLUORANTHENE	5.0	U	ug/L	5.0	TKA	11/03/00	10/30/00
625	FLUORENE	5.0	U	ug/L	5.0	TKA	11/03/00	10/30/00
625	HEXACHLOROBENZENE	5.0	U	ug/L	5.0	TKA	11/03/00	10/30/00
625	HEXACHLOROBUTADIENE	5.0	U	ug/L	5.0	TKA	11/03/00	10/30/00
625	HEXACHLOROCYCLOPENTADIENE	5.0	U	ug/L	5.0	TKA	11/03/00	10/30/00
625	HEXACHLOROETHANE	5.0	U	ug/L	5.0	TKA	11/03/00	10/30/00
625	INDENO (1,2,3-CD) PYRENE	5.0	U	ug/L	5.0	TKA	11/03/00	10/30/00
625	ISOPHORONE	5.0	U	ug/L	5.0	TKA	11/03/00	10/30/00
625	NAPHTHALENE	5.0	U	ug/L	5.0	TKA	11/03/00	10/30/00
625	NITROBENZENE	5.0	U	ug/L	5.0	TKA	11/03/00	10/30/00
625	2-NITROPHENOL	5.0	U	ug/L	5.0	TKA	11/03/00	10/30/00
625	4-NITROPHENOL	20	U	ug/L	20	TKA	11/03/00	10/30/00
625	N-NITROSODIMETHYLAMINE	5.0	U	ug/L	5.0	TKA	11/03/00	10/30/00
625	N-NITROSODIPHENYLAMINE	5.0	U	ug/L	5.0	TKA	11/03/00	10/30/00
625	N-NITROSODI-n-PROPYLAMINE	5.0	U	ug/L	5.0	TKA	11/03/00	10/30/00
625	PENTACHLOROPHENOL	20	U	ug/L	20	TKA	11/03/00	10/30/00
625	PHENANTHRENE	5.0	U	ug/L	5.0	TKA	11/03/00	10/30/00
625	PHENOL	5.0	U	ug/L	5.0	TKA	11/03/00	10/30/00
625	PYRENE	5.0	U	ug/L	5.0	TKA	11/03/00	10/30/00
625	1,2,4-TRICHLOROBENZENE	5.0	U	ug/L	5.0	TKA	11/03/00	10/30/00
625	2,4,6-TRICHLOROPHENOL	5.0	U	ug/L	5.0	TKA	11/03/00	10/30/00
<u>DRINKING WATER REG. VOLATILE ORGANICS</u>								
502.2	BENZENE	0.50	U	ug/L	0.50	RM	10/30/00	
502.2	CARBON TETRACHLORIDE	0.50	U	ug/L	0.50	RM	10/30/00	
502.2	o-DICHLOROBENZENE	0.50	U	ug/L	0.50	RM	10/30/00	

MR. RICHARD MOULTON
 CITY OF FORT MYERS
 2751 JACKSONVILLE ST
 FORT MYERS, FL 33916

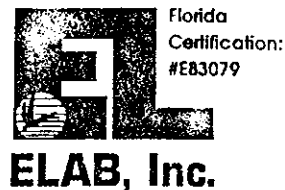

ANALYTICAL REPORT

Page 3

Submission Number: 10000531 Client's P.O. Number:
 Date Received: 10/24/00 Project Number:
 Date Reported: 12/04/00 Project Name:
 Elab Report Name: Finalnew->Final2.RP1

Lab Sample Number: 0010531 1 Date Sampled: 10/23/00
 Client Sample Number: Sample Matrix: DRINKING WATER
 Sample Description: DEEP WELL (P 6)

Method	Analyte	Result	Q	Units	Reporting Limit	Analyst	Date Analyzed	Prepared
<u>DRINKING WATER REG. VOLATILE ORGANICS</u>								
502.2	p-DICHLOROBENZENE	0.50	U	ug/L	0.50	RM	10/30/00	
502.2	1,2-DICHLOROETHANE	0.50	U	ug/L	0.50	RM	10/30/00	
502.2	1,1-DICHLOROETHENE	0.50	U	ug/L	0.50	RM	10/30/00	
502.2	cis-1,2-DICHLOROETHYLENE	0.50	U	ug/L	0.50	RM	10/30/00	
502.2	trans-1,2-DICHLOROETHYLENE	0.50	U	ug/L	0.50	RM	10/30/00	
502.2	DICHLOROMETHANE	0.50	U	ug/L	0.50	RM	10/30/00	
502.2	1,2-DICHLOROPROPANE	0.50	U	ug/L	0.50	RM	10/30/00	
502.2	ETHYLBENZENE	0.50	U	ug/L	0.50	RM	10/30/00	
502.2	MONOCHLOROBENZENE	0.50	U	ug/L	0.50	RM	10/30/00	
502.2	STYRENE	0.50	U	ug/L	0.50	RM	10/30/00	
502.2	TETRACHLOROETHYLENE	0.50	U	ug/L	0.50	RM	10/30/00	
502.2	TOLUENE	0.50	U	ug/L	0.50	RM	10/30/00	
502.2	1,2,4-TRICHLOROBENZENE	0.50	U	ug/L	0.50	RM	10/30/00	
502.2	1,1,1-TRICHLOROETHANE	0.50	U	ug/L	0.50	RM	10/30/00	
502.2	1,1,2-TRICHLOROETHANE	0.50	U	ug/L	0.50	RM	10/30/00	
502.2	TRICHLOROETHYLENE	0.50	U	ug/L	0.50	RM	10/30/00	
502.2	VINYL CHLORIDE	0.50	U	ug/L	0.50	RM	10/30/00	
502.2	XYLENES (Total)	0.50	U	ug/L	0.50	RM	10/30/00	
<u>DW CHLORINATED PESTICIDES & PCB</u>								
505	ALACHLOR	1.0	U	ug/L	1.0	TCZ	10/25/00	10/24/00
505	ATRAZINE	1.5	U	ug/L	1.5	TCZ	10/25/00	10/24/00
505	g-BHC (LINDANE)	0.010	U	ug/L	0.010	TCZ	10/25/00	10/24/00
505	CHLORDANE	0.020	U	ug/L	0.020	TCZ	10/25/00	10/24/00
505	ENDRIN	0.010	U	ug/L	0.010	TCZ	10/25/00	10/24/00
505	HEPTACHLOR	0.030	U	ug/L	0.030	TCZ	10/25/00	10/24/00
505	HEPTACHLOR EPOXIDE	0.010	U	ug/L	0.010	TCZ	10/25/00	10/24/00
505	HEXACHLOROBENZENE	0.10	U	ug/L	0.10	TCZ	10/25/00	10/24/00
505	HEXACHLOROCYCLOPENTADIENE	0.10	U	ug/L	0.10	TCZ	10/25/00	10/24/00
505	METHOXYCHLOR	0.050	U	ug/L	0.050	TCZ	10/25/00	10/24/00
505	SIMAZINE	1.5	U	ug/L	1.5	TCZ	10/25/00	10/24/00
505	TOXAPHENE	0.18	U	ug/L	0.18	TCZ	10/25/00	10/24/00

MR. RICHARD MOULTON
 CITY OF FORT MYERS
 2751 JACKSONVILLE ST
 FORT MYERS, FL 33916

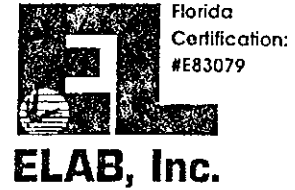

ANALYTICAL REPORT

Submission Number: 10000531 Client's P.O. Number:
 Date Received: 10/24/00 Project Number:
 Date Reported: 12/04/00 Project Name:
 Elab Report Name: Finalnew->Final2.RP1

Lab Sample Number: 0010531 1 Date Sampled: 10/23/00
 Client Sample Number: Sample Matrix: DRINKING WATER
 Sample Description: DEEP WELL (P 6)

Method	Analyte	Result	Q	Units	Reporting Limit	Analyst	Date Analyzed	Prepared
<u>DW CHLORINATED PESTICIDES & PCB</u>								
505	PCB 1016	0.10	U	ug/L	0.10	TCZ	10/25/00	10/24/00
505	PCB 1221	0.10	U	ug/L	0.10	TCZ	10/25/00	10/24/00
505	PCB 1232	0.10	U	ug/L	0.10	TCZ	10/25/00	10/24/00
505	PCB 1242	0.10	U	ug/L	0.10	TCZ	10/25/00	10/24/00
505	PCB 1248	0.10	U	ug/L	0.10	TCZ	10/25/00	10/24/00
505	PCB 1254	0.10	U	ug/L	0.10	TCZ	10/25/00	10/24/00
505	PCB 1260	0.10	U	ug/L	0.10	TCZ	10/25/00	10/24/00
505	TOTAL PCB'S	0.10	U	ug/L	0.10	TCZ	10/25/00	10/24/00
<u>DRINKING WATER ORGANIC HERBICIDES</u>								
515.1	2,4-D	0.10	U	ug/L	0.10	OAO	10/26/00	10/25/00
515.1	DALAPON	1.0	U	ug/L	1.0	OAO	10/26/00	10/25/00
515.1	DINOSEB	0.20	U	ug/L	0.20	OAO	10/26/00	10/25/00
515.1	PENTACHLOROPHENOL	0.040	U	ug/L	0.040	OAO	10/26/00	10/25/00
515.1	PICLORAM	0.10	U	ug/L	0.10	OAO	10/26/00	10/25/00
515.1	2,4,5-TP (SILVEX)	0.20	U	ug/L	0.20	OAO	10/26/00	10/25/00
<u>DRINKING WATER ORGANIC CARBAMATES</u>								
531.1	CARBOFURAN	2.0	U	ug/L	2.0	KHA	10/25/00	10/24/00
531.1	OXAMYL (VYDATE)	2.0	U	ug/L	2.0	KHA	10/25/00	10/24/00
<u>DW DISINFECTANT BY-PRODUCTS</u>								
504.1	1,2-DIBROMO-3-CHLOROPROPANE	0.020	U	ug/L	0.020	OAO	10/27/00	10/27/00
504.1	ETHYLENE DIBROMIDE	0.010	U	ug/L	0.010	OAO	10/27/00	10/27/00
<u>DW MISC. SOC'S - GLYPHOSATE</u>								
547	GLYPHOSATE	6.0	U	ug/L	6.0	KHA	10/26/00	
<u>DW MISC. SOC'S - ENDOTHALL</u>								
548.1	ENDOTHALL	9.0	U	ug/L	9.0	TKA	10/30/00	10/25/00
<u>DW MISC. SOC'S - DIQUAT</u>								
549.1	DIQUAT	0.40	U	ug/L	0.40	KHA	03/01/00	10/25/00
<u>DW ADIPATES, PHTHALATES, AND PAH'S</u>								
525.2	BENZO(A)PYRENE	0.10	U	ug/L	0.10	TKA	10/26/00	10/25/00
525.2	DI(2-ETHYLHEXYL)PHTHALATE	2.0	U	ug/L	2.0	TKA	10/26/00	10/25/00
525.2	DI(2-ETHYLHEXYL)ADIPATE	1.6	U	ug/L	1.6	TKA	10/26/00	10/25/00

MR. RICHARD MOULTON
 CITY OF FORT MYERS
 2751 JACKSONVILLE ST
 FORT MYERS, FL 33916

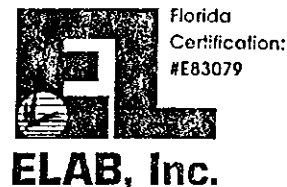

ANALYTICAL REPORT

Submission Number: 10000531 Client's P.O. Number:
 Date Received: 10/24/00 Project Number:
 Date Reported: 12/04/00 Project Name:
 Elab Report Name: Finalnew->Final2.RP1

Lab Sample Number: 0010531 1 Date Sampled: 10/23/00
 Client Sample Number: Sample Matrix: DRINKING WATER
 Sample Description: DEEP WELL (P 6)

Method	Analyte	Result	Q	Units	Reporting		Date Analyzed	Prepared
					Limit	Analyst		
SM2120B	COLOR	5.0	U	UNIT	5.0	MRO	10/24/00	
120.1	SPECIFIC CONDUCTANCE	3500		umhos/cm	1.0	MRO	10/24/00	
SM2150B	ODOR	1.0		TON	1.0	MRO	10/24/00	
150.1	pH	7.55		UNIT	N/A	MRO	10/24/00	
SM2540C	TOTAL DISSOLVED SOLIDS (TDS)	2100		mg/L	5.0	MRO	10/26/00	
SM4500CN-E	CYANIDE - TOTAL	0.010	U	mg/L	0.010	TPE	10/30/00	
370.1	DISSOLVED SILICA	16		mg/L	2.0	KFE	10/31/00	
310.1	HYDROXIDE ALK. as CaCO3	5.0	U	mg/L	5.0	KFE	10/24/00	
SM4500NH3D	AMMONIA NITROGEN (as N)	0.66		mg/L	0.050	TPE	10/27/00	
415.1	TOTAL ORGANIC CARBON (TOC)	1.0	U	mg/L	1.0	TPE	10/31/00	
SM5540C	SURFACTANTS (MBAS)	0.10	U	mg/L	0.10	TPE	10/25/00	10:00
900.0	GROSS ALPHA	6.8+/-2.8		pCi/L		FRS	11/03/00	
903.1	RADIUM 226	5.8+/-0.3		pCi/L		FRS	11/09/00	
EPA ALT.	RADIUM 228	0.9+/-0.6		pCi/L		FRS	11/09/00	
300.0	CHLORIDE	780		mg/L	0.50	KFE	10/24/00	
300.0	FLUORIDE	1.6		mg/L	0.050	KFE	10/24/00	
300.0	NITRATE NITROGEN (as N)	0.050	U	mg/L	0.050	KFE	10/24/00	16:34
300.0	NITRITE NITROGEN (as N)	0.050	U	mg/L	0.050	KFE	10/24/00	16:34
300.0	SULFATE	300		mg/L	0.50	KFE	10/24/00	
SM3113B	ANTIMONY (TOTAL)	3.0	U	ug/L	3.0	JAS	10/26/00	
SM3113B	LEAD (TOTAL)	2.0	U	ug/L	2.0	EM	10/30/00	
245.1	MERCURY	0.20	U	ug/L	0.20	EM	10/30/00	
SM3113B	SELENIUM (TOTAL)	4.0	U	ug/L	4.0	EM	10/31/00	
200.9	THALLIUM (TOTAL)	1.0	U	ug/L	1.0	EM	10/30/00	
200.7	STRONTIUM (TOTAL)	18000		ug/L	100	JAS	10/30/00	
200.7	ALUMINUM (TOTAL)	100	U	ug/L	100	EM	10/27/00	
200.7	ARSENIC (TOTAL)	5.0	U	ug/L	5.0	EM	10/27/00	
200.7	BARIUM (TOTAL)	25		ug/L	10	EM	10/27/00	
200.7	BERYLLIUM (TOTAL)	1.0	U	ug/L	1.0	EM	10/27/00	
200.7	CADMIUM (TOTAL)	1.0	U	ug/L	1.0	EM	10/27/00	
200.7	CALCIUM (TOTAL)	120		mg/L	0.50	EM	10/27/00	
200.7	CHROMIUM (TOTAL)	5.0	U	ug/L	5.0	EM	10/27/00	

MR. RICHARD MOULTON
 CITY OF FORT MYERS
 2751 JACKSONVILLE ST
 FORT MYERS, FL 33916



ANALYTICAL REPORT

Submission Number: 10000531 Client's P.O. Number:
 Date Received: 10/24/00 Project Number:
 Date Reported: 12/04/00 Project Name:
 Elab Report Name: Finalnew->Final2.RP1

Lab Sample Number: 0010531 1 Date Sampled: 10/23/00
 Client Sample Number: Sample Matrix: DRINKING WATER
 Sample Description: DEEP WELL (P 6)

Method	Analyte	Result	Q	Units	Reporting Limit	Analyst	Date Analyzed	Prepared
200.7	COPPER (TOTAL)	10	U	ug/L	10	EM	10/27/00	
200.7	IRON (TOTAL)	40	U	ug/L	40	EM	10/27/00	
200.7	MAGNESIUM (TOTAL)	96		mg/L	0.50	EM	10/27/00	
200.7	MANGANESE (TOTAL)	5.0	U	ug/L	5.0	EM	10/27/00	
200.7	NICKEL (TOTAL)	10	U	ug/L	10	EM	10/27/00	
200.7	SILVER (TOTAL)	10	U	ug/L	10	EM	10/27/00	
200.7	SODIUM (TOTAL)	440		mg/L	0.50	EM	10/27/00	
200.7	ZINC (TOTAL)	20	U	ug/L	20	EM	10/27/00	
<u>PRIORITY POLLUTANT PEST. AND PCB'S</u>								
608	ALDRIN	0.0050	U	ug/L	0.0050	TCZ	11/01/00	10/30/00
608	a-BHC	0.0050	U	ug/L	0.0050	TCZ	11/01/00	10/30/00
608	b-BHC	0.020	U	ug/L	0.020	TCZ	11/01/00	10/30/00
608	d-BHC	0.020	U	ug/L	0.020	TCZ	11/01/00	10/30/00
608	g-BHC (LINDANE)	0.020	U	ug/L	0.020	TCZ	11/01/00	10/30/00
608	CHLORDANE (tech.)	0.50	U	ug/L	0.50	TCZ	11/01/00	10/30/00
608	4,4'-DDD	0.020	U	ug/L	0.020	TCZ	11/01/00	10/30/00
608	4,4'-DDE	0.020	U	ug/L	0.020	TCZ	11/01/00	10/30/00
608	4,4'-DDT	0.020	U	ug/L	0.020	TCZ	11/01/00	10/30/00
608	DIELDRIN	0.0050	U	ug/L	0.0050	TCZ	11/01/00	10/30/00
608	ENDOSULFAN I	0.020	U	ug/L	0.020	TCZ	11/01/00	10/30/00
608	ENDOSULFAN II	0.020	U	ug/L	0.020	TCZ	11/01/00	10/30/00
608	ENDOSULFAN SULFATE	0.020	U	ug/L	0.020	TCZ	11/01/00	10/30/00
608	ENDRIN	0.010	U	ug/L	0.010	TCZ	11/01/00	10/30/00
608	ENDRIN ALDEHYDE	0.020	U	ug/L	0.020	TCZ	11/01/00	10/30/00
608	HEPTACHLOR	0.020	U	ug/L	0.020	TCZ	11/01/00	10/30/00
608	HEPTACHLOR EPOXIDE	0.020	U	ug/L	0.020	TCZ	11/01/00	10/30/00
608	METHOXYCHLOR	0.020	U	ug/L	0.020	TCZ	11/01/00	10/30/00
608	TOXAPHENE	0.50	U	ug/L	0.50	TCZ	11/01/00	10/30/00
608	PCB 1016	0.50	U	ug/L	0.50	TCZ	11/01/00	10/30/00
608	PCB 1221	0.50	U	ug/L	0.50	TCZ	11/01/00	10/30/00
608	PCB 1232	0.50	U	ug/L	0.50	TCZ	11/01/00	10/30/00
608	PCB 1242	0.50	U	ug/L	0.50	TCZ	11/01/00	10/30/00

MR. RICHARD MOULTON
 CITY OF FORT MYERS
 2751 JACKSONVILLE ST
 FORT MYERS, FL 33916



ANALYTICAL REPORT

Submission Number: 10000531 Client's P.O. Number:
 Date Received: 10/24/00 Project Number:
 Date Reported: 12/04/00 Project Name:
 Elab Report Name: Finalnew->Final2.RP1

Lab Sample Number: 0010531 1 Date Sampled: 10/23/00
 Client Sample Number:
 Sample Description: DEEP WELL (P 6) Sample Matrix: DRINKING WATER

Method	Analyte	Result	Q	Units	Reporting		Date Analyzed	Prepared
					Limit	Analyst		
<u>PRIORITY POLLUTANT PEST. AND PCB'S</u>								
608	PCB 1248	0.50	U	ug/L	0.50	TCZ	11/01/00	10/30/00
608	PCB 1254	0.50	U	ug/L	0.50	TCZ	11/01/00	10/30/00
608	PCB 1260	0.50	U	ug/L	0.50	TCZ	11/01/00	10/30/00
<u>PRIORITY POLLUTANT VOLATILE ORGANICS</u>								
624	ACROLEIN	20	U	ug/L	20	JSA	10/30/00	
624	ACRYLONITRILE	20	U	ug/L	20	JSA	10/30/00	
624	BENZENE	1.0	U	ug/L	1.0	JSA	10/30/00	
624	BROMODICHLOROMETHANE	1.0	U	ug/L	1.0	JSA	10/30/00	
624	BROMOFORM	1.0	U	ug/L	1.0	JSA	10/30/00	
624	BROMOMETHANE	1.0	U	ug/L	1.0	JSA	10/30/00	
624	CARBON TETRACHLORIDE	1.0	U	ug/L	1.0	JSA	10/30/00	
624	CHLOROBENZENE	1.0	U	ug/L	1.0	JSA	10/30/00	
624	CHLOROETHANE	1.0	U	ug/L	1.0	JSA	10/30/00	
624	2-CHLOROETHYL VINYL ETHER	10	U	ug/L	10	JSA	10/30/00	
624	CHLOROFORM	1.0	U	ug/L	1.0	JSA	10/30/00	
624	CHLOROMETHANE	1.0	U	ug/L	1.0	JSA	10/30/00	
624	DIBROMOCHLOROMETHANE	1.0	U	ug/L	1.0	JSA	10/30/00	
624	1,2-DICHLOROBENZENE	1.0	U	ug/L	1.0	JSA	10/30/00	
624	1,3-DICHLOROBENZENE	1.0	U	ug/L	1.0	JSA	10/30/00	
624	1,4-DICHLOROBENZENE	1.0	U	ug/L	1.0	JSA	10/30/00	
624	1,1-DICHLOROETHANE	1.0	U	ug/L	1.0	JSA	10/30/00	
624	1,2-DICHLOROETHANE	1.0	U	ug/L	1.0	JSA	10/30/00	
624	1,1-DICHLOROETHENE	1.0	U	ug/L	1.0	JSA	10/30/00	
624	trans-1,2-DICHLOROETHENE	1.0	U	ug/L	1.0	JSA	10/30/00	
624	1,2-DICHLOROPROPANE	1.0	U	ug/L	1.0	JSA	10/30/00	
624	cis-1,3-DICHLOROPROPENE	5.0	U	ug/L	5.0	JSA	10/30/00	
624	trans-1,3-DICHLOROPROPENE	5.0	U	ug/L	5.0	JSA	10/30/00	
624	ETHYLBENZENE	1.0	U	ug/L	1.0	JSA	10/30/00	
624	METHYLENE CHLORIDE	5.0	U	ug/L	5.0	JSA	10/30/00	
624	1,1,2,2-TETRACHLOROETHANE	1.0	U	ug/L	1.0	JSA	10/30/00	
624	TETRACHLOROETHENE	1.0	U	ug/L	1.0	JSA	10/30/00	

MR. RICHARD MOULTON
CITY OF FORT MYERS
2751 JACKSONVILLE ST
FORT MYERS, FL 33916



ANALYTICAL REPORT

Page 8

Submission Number: 10000531 Client's P.O. Number:
Date Received: 10/24/00 Project Number:
Date Reported: 12/04/00 Project Name:
Elab Report Name: Finalnew->Final2.RP1

Lab Sample Number: 0010531 1 Date Sampled: 10/23/00
Client Sample Number: Sample Matrix: DRINKING WATER
Sample Description: DEEP WELL (P 6)

Method	Analyte	Result	Q	Units	Reporting		Date Analyzed	Prepared
					Limit	Analyst		
<u>PRIORITY POLLUTANT VOLATILE ORGANICS</u>								
624	TOLUENE	1.0	U	ug/L	1.0	JSA	10/30/00	
624	1,1,1-TRICHLOROETHANE	1.0	U	ug/L	1.0	JSA	10/30/00	
624	1,1,2-TRICHLOROETHANE	1.0	U	ug/L	1.0	JSA	10/30/00	
624	TRICHLOROETHENE	1.0	U	ug/L	1.0	JSA	10/30/00	
624	TRICHLOROFLUOROMETHANE	1.0	U	ug/L	1.0	JSA	10/30/00	
624	VINYL CHLORIDE	1.0	U	ug/L	1.0	JSA	10/30/00	

Data Qualifier Code Key:

U - The analyte was analyzed for, but was not detected above the reported sample quantitation limit.

CERTIFICATION: All analytical data reported above were obtained using the specified methods and were validated by our laboratory quality control system. This laboratory follows an approved quality assurance program.

Respectfully submitted:



Paul K. Canevaro
Laboratory Director

CASE NARRATIVE

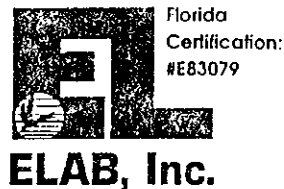

LABORATORY: ELAB, Inc.
SUBMISSION NUMBER: 10000531
DATE RECEIVED: 10/24/00
DATE RESULTS REPORTED: 11/17/00

<p>I. Sample Receiving Activity All samples received intact and preserved with the following exception: 1. The sample aliquot for odor was received after the holding time expired.</p>
<p>II. Data N/A</p>
<p>III. Quality Control All Quality Control data meets the specified method criteria.</p>
<p>IV. Other Comments</p>

PREPARED BY:  **DATE:** 11/17/00
Myrna Lueckert, Project Manager

V:\ADMIN\LETTERS\MYRNA\CASENAR\Cn10-531.DOC

Mailing - P.O. Box 468 • Ormond Beach, Florida 32175-0468 • Shipping - 8 East Tower Circle • Ormond Beach, Florida 32174
(904) 672-5668 • Fax (904) 673-4001

Puerto Rico: Office (787) 787-0866 • Cellular (787) 390-3505 or (787) 399-4683

APPENDIX J.5

Well P-7 Ambient Water Quality Results

MR. RICHARD MOUTON
 CITY OF FORT MYERS
 2751 JACKSONVILLE ST
 FORT MYERS, FL 33916



P7

ANALYTICAL REPORT

Page 1

Submission Number: 10000728 Client's P.O. Number:
 Date Received: 10/31/00 Project Number:
 Date Reported: 12/05/00 Project Name:
 Fish Report Name: Finalnew->Final2.RF1

Lab Sample Number: 0010728 1 Date Sampled: 10/30/00
 Client Sample Number: Sample Matrix: DRINKING WATER
 Sample Description: DEEP WELL P7

Method	Analyte	Result	Q	Units	Limit	Reporting Analyst	Date Analyzed	Prepared
PRIORITY POLLUTANT S/M/A EXTRACTABLES								
625	ACENAPHTHENE	5.0	U	ug/L	5.0	VG	11/16/00	11/03/00
625	ACENAPHTHYLENE	5.0	U	ug/L	5.0	VG	11/16/00	11/03/00
625	ANTHRACENE	5.0	U	ug/L	5.0	VG	11/16/00	11/03/00
625	BENZIDINE	25	U	ug/L	25	VG	11/16/00	11/03/00
625	BENZ(A)ANTHRACENE	5.0	U	ug/L	5.0	VG	11/16/00	11/03/00
625	BENZO(B)FLUORANTHENE	5.0	U	ug/L	5.0	VG	11/16/00	11/03/00
625	BENZO(K)FLUORANTHENE	5.0	U	ug/L	5.0	VG	11/16/00	11/03/00
625	BENZO(G,H,I)PERYLENE	5.0	U	ug/L	5.0	VG	11/16/00	11/03/00
625	BENZO(A)PYRENE	5.0	U	ug/L	5.0	VG	11/16/00	11/03/00
625	BIS(2-CHLOROPHOXY) METHANE	5.0	U	ug/L	5.0	VG	11/16/00	11/03/00
625	BIS(2-CHLOROETHYL) ETHER	5.0	U	ug/L	5.0	VG	11/16/00	11/03/00
625	BIS(2-CHLOROISOPROPYL) ETHER	5.0	U	ug/L	5.0	VG	11/16/00	11/03/00
625	BIS(2-ETHYLHEXYL) PHTHALATE	5.0	U	ug/L	5.0	VG	11/16/00	11/03/00
625	4-BROMOPHENYL PHENYL ETHER	5.0	U	ug/L	5.0	VG	11/16/00	11/03/00
625	BUTYL BENZYL PHTHALATE	5.0	U	ug/L	5.0	VG	11/16/00	11/03/00
625	2-CHLORONAPHTHALENE	5.0	U	ug/L	5.0	VG	11/16/00	11/03/00
625	4-CHLORO-3-METHYLPHENOL	20	U	ug/L	20	VG	11/16/00	11/03/00
625	2-CHLOROPHENOL	5.0	U	ug/L	5.0	VG	11/16/00	11/03/00
625	4-CHLOROPHENYL PHENYL ETHER	5.0	U	ug/L	5.0	VG	11/16/00	11/03/00
625	CHRYSENE	5.0	U	ug/L	5.0	VG	11/16/00	11/03/00
625	DIBENZO(A,H)ANTHRACENE	5.0	U	ug/L	5.0	VG	11/16/00	11/03/00
625	DI-n-BUTYLPHTHALATE	5.0	U	ug/L	5.0	VG	11/16/00	11/03/00
625	1,2-DICHLOROBENZENE	5.0	U	ug/L	5.0	VG	11/16/00	11/03/00
625	1,3-DICHLOROBENZENE	5.0	U	ug/L	5.0	VG	11/16/00	11/03/00
625	1,4-DICHLOROBENZENE	5.0	U	ug/L	5.0	VG	11/16/00	11/03/00
625	3,3'-DICHLOROBENZIDINE	20	U	ug/L	20	VG	11/16/00	11/03/00
625	2,4-DICHLOROPHENOL	5.0	U	ug/L	5.0	VG	11/16/00	11/03/00
625	DIETHYLPHTHALATE	5.0	U	ug/L	5.0	VG	11/16/00	11/03/00
625	2,4-DIMETHYLPHENOL	5.0	U	ug/L	5.0	VG	11/16/00	11/03/00
625	DIMETHYLPHTHALATE	5.0	U	ug/L	5.0	VG	11/16/00	11/03/00
625	4,6-DINITRO-2-METHYLPHENOL	20	U	ug/L	20	VG	11/16/00	11/03/00

MR. RICHARD MOULTON
 CITY OF FORT MYERS
 2751 JACKSONVILLE ST
 FORT MYERS, FL 33916



ANALYTICAL REPORT

Submission Number: 10000728
 Date Received: 10/31/00
 Date Reported: 12/05/00

Client's P.O. Number:
 Project Number:
 Project Name:
 Elab Report Name: Finalnew->Final2.RP1

Lab Sample Number: 0010728 1
 Client Sample Number:
 Sample Description: DEEP WELL #7

Date Sampled: 10/30/00
 Sample Matrix: DRINKING WATER

Method	Analyte	Result	Q	Units	Reporting Limit	Analyst	Date Analyzed	Prepared
<u>PRIORITY POLLUTANT B/N/A EXTRACTABLES</u>								
625	2,4-DINITROPHENOL	20	U	ug/L	20	VG	11/16/00	11/03/00
625	2,4-DINITROTOLUENE	5.0	U	ug/L	5.0	VG	11/16/00	11/03/00
625	2,6-DINITROTOLUENE	5.0	U	ug/L	5.0	VG	11/16/00	11/03/00
625	1,2-DIPHENYLHYDRAZINE	5.0	U	ug/L	5.0	VG	11/16/00	11/03/00
625	DI-n-OCTYLPHTHALATE	5.0	U	ug/L	5.0	VG	11/16/00	11/03/00
625	DIOXIN (2,3,7,8-TCDD) (SCREEN)	100	U	ug/L	100	VG	11/16/00	11/03/00
625	FLUORANTHENE	5.0	U	ug/L	5.0	VG	11/16/00	11/03/00
625	FLUORENE	5.0	U	ug/L	5.0	VG	11/16/00	11/03/00
625	HEXACHLOROBENZENE	5.0	U	ug/L	5.0	VG	11/16/00	11/03/00
625	HEXACHLOROCYCLOPENTADIENE	5.0	U	ug/L	5.0	VG	11/16/00	11/03/00
625	HEXACHLOROCYCLOPENTADIENE	5.0	U	ug/L	5.0	VG	11/16/00	11/03/00
625	HEXACHLOROETHANE	5.0	U	ug/L	5.0	VG	11/16/00	11/03/00
625	INDENO (1,2,3-CD) PYRENE	5.0	U	ug/L	5.0	VG	11/16/00	11/03/00
625	ISOPHORONE	5.0	U	ug/L	5.0	VG	11/16/00	11/03/00
625	NAPHTHALENE	5.0	U	ug/L	5.0	VG	11/16/00	11/03/00
625	NITROBENZENE	5.0	U	ug/L	5.0	VG	11/16/00	11/03/00
625	2-NITROPHENOL	5.0	U	ug/L	5.0	VG	11/16/00	11/03/00
625	4-NITROPHENOL	20	U	ug/L	20	VG	11/16/00	11/03/00
625	N-NITROSODIMETHYLAMINE	5.0	U	ug/L	5.0	VG	11/16/00	11/03/00
625	N-NITROSODIPHENYLAMINE	5.0	U	ug/L	5.0	VG	11/16/00	11/03/00
625	N-NITROSODI-n-PROPYLAMINE	5.0	U	ug/L	5.0	VG	11/16/00	11/03/00
625	PENTACHLOROPHENOL	20	U	ug/L	20	VG	11/16/00	11/03/00
625	PHENANTHRENE	5.0	U	ug/L	5.0	VG	11/16/00	11/03/00
625	PHENOL	5.0	U	ug/L	5.0	VG	11/16/00	11/03/00
625	PYRENE	5.0	U	ug/L	5.0	VG	11/16/00	11/03/00
625	1,2,4-TRICHLOROBENZENE	5.0	U	ug/L	5.0	VG	11/16/00	11/03/00
625	2,4,6-TRICHLOROPHENOL	5.0	U	ug/L	5.0	VG	11/16/00	11/03/00
<u>DRINKING WATER REG. VOLATILE ORGANICS</u>								
502.2	BENZENE	0.50	U	ug/L	0.50	RME	11/09/00	
502.2	CARBON TETRACHLORIDE	0.50	U	ug/L	0.50	RME	11/09/00	
502.2	o-DICHLOROBENZENE	0.50	U	ug/L	0.50	RME	11/09/00	

MR. RICHARD MOULTON
 CITY OF PORT MYERS
 2751 JACKSONVILLE ST
 PORT MYERS, FL 33916



ANALYTICAL REPORT

Submission Number: 10000728 Client's P.O. Number:
 Date Received: 10/31/00 Project Number:
 Date Reported: 12/05/00 Project Name:
 Elab Report Name: Finalnew->Final2.RP1

Lab Sample Number: 0010728 1 Date Sampled: 10/30/00
 Client Sample Number: Sample Matrix: DRINKING WATER
 Sample Description: DEEP WELL P7

Method	Analyte	Result	Q	Units	Reporting Limit	Analyst	Date Analyzed	Prepared
<u>DRINKING WATER REG. VOLATILE ORGANICS</u>								
502.2	p-DICHLOROBENZENE	0.50	U	ug/L	0.50	RME	11/09/00	
502.2	1,2-DICHLOROETHANE	0.50	U	ug/L	0.50	RME	11/09/00	
502.2	1,1-DICHLOROETHENE	0.50	U	ug/L	0.50	RME	11/09/00	
502.2	cis-1,2-DICHLOROETHYLENE	0.50	U	ug/L	0.50	RME	11/09/00	
502.2	trans-1,2-DICHLOROETHYLENE	0.50	U	ug/L	0.50	RME	11/09/00	
502.2	DICHLOROMETHANE	0.50	U	ug/L	0.50	RME	11/09/00	
502.2	1,2-DICHLOROPROPANE	0.50	U	ug/L	0.50	RME	11/09/00	
502.2	ETHYLBENZENE	0.50	U	ug/L	0.50	RME	11/09/00	
502.2	MONOCHLOROBENZENE	0.50	U	ug/L	0.50	RME	11/09/00	
502.2	STYRENE	0.50	U	ug/L	0.50	RME	11/09/00	
502.2	TETRACHLOROETHYLENE	0.50	U	ug/L	0.50	RME	11/09/00	
502.2	TOLUENE	0.50	U	ug/L	0.50	RME	11/09/00	
502.2	1,2,4-TRICHLOROBENZENE	0.50	U	ug/L	0.50	RME	11/09/00	
502.2	1,1,1-TRICHLOROETHANE	0.50	U	ug/L	0.50	RME	11/09/00	
502.2	1,1,2-TRICHLOROETHANE	0.50	U	ug/L	0.50	RME	11/09/00	
502.2	TRICHLOROETHYLENE	0.50	U	ug/L	0.50	RME	11/09/00	
502.2	VINYL CHLORIDE	0.50	U	ug/L	0.50	RME	11/09/00	
502.2	XYLENES (Total)	0.50	U	ug/L	0.50	RME	11/09/00	
<u>DW CHLORINATED PESTICIDES & PCB</u>								
505	ALACHLOR	1.0	U	ug/L	1.0	TCZ	11/04/00	11/03/00
505	ATRAZINE	1.5	U	ug/L	1.5	TCZ	11/04/00	11/03/00
505	g-BHC (LINDANE)	0.010	U	ug/L	0.010	TCZ	11/04/00	11/03/00
505	CHLORDANE	0.020	U	ug/L	0.020	TCZ	11/04/00	11/03/00
505	ENDRIN	0.010	U	ug/L	0.010	TCZ	11/04/00	11/03/00
505	HEPTACHLOR	0.030	U	ug/L	0.030	TCZ	11/04/00	11/03/00
505	HEPTACHLOR EPOXIDE	0.010	U	ug/L	0.010	TCZ	11/04/00	11/03/00
505	HEXACHLOROBENZENE	0.10	U	ug/L	0.10	TCZ	11/04/00	11/03/00
505	HEXACHLOROCYCLOPENTADIENE	0.10	U	ug/L	0.10	TCZ	11/04/00	11/03/00
505	METHOXYCHLOR	0.050	U	ug/L	0.050	TCZ	11/04/00	11/03/00
505	SIMAZINE	1.5	U	ug/L	1.5	TCZ	11/04/00	11/03/00
505	TOXAPHENE	0.18	U	ug/L	0.18	TCZ	11/04/00	11/03/00

MR. RICHARD MOULTON
 CITY OF FORT MYERS
 2751 JACKSONVILLE ST
 FORT MYERS, FL 33916



ANALYTICAL REPORT

Submission Number: 10000728 Client's P.O. Number:
 Date Received: 10/31/00 Project Number:
 Date Reported: 12/05/00 Project Name:
 Elab Report Name: Finalnew->Final2.RP1

Lab Sample Number: 0010728 1 Date Sampled: 10/30/00
 Client Sample Number: Sample Matrix: DRINKING WATER
 Sample Description: DEEP WELL P7

Method	Analyte	Result	Q	Units	Reporting Limit	Analyst	Date Analyzed	Prepared
<u>DW CHLORINATED PESTICIDES & PCB</u>								
505	PCB 1016	0.10	U	ug/L	0.10	TCZ	11/04/00	11/03/00
505	PCB 1221	0.10	U	ug/L	0.10	TCZ	11/04/00	11/03/00
505	PCB 1232	0.10	U	ug/L	0.10	TCZ	11/04/00	11/03/00
505	PCB 1242	0.10	U	ug/L	0.10	TCZ	11/04/00	11/03/00
505	PCB 1248	0.10	U	ug/L	0.10	TCZ	11/04/00	11/03/00
505	PCB 1254	0.10	U	ug/L	0.10	TCZ	11/04/00	11/03/00
505	PCB 1260	0.10	U	ug/L	0.10	TCZ	11/04/00	11/03/00
505	TOTAL PCB'S	0.10	U	ug/L	0.10	TCZ	11/04/00	11/03/00
<u>DRINKING WATER ORGANIC HERBICIDES</u>								
515.1	2,4-D	0.10	U	ug/L	0.10	OAO	11/08/00	11/06/00
515.1	DALAPON	1.0	U	ug/L	1.0	OAO	11/08/00	11/06/00
515.1	DINOSFB	0.20	U	ug/L	0.20	OAO	11/08/00	11/06/00
515.1	PENTACHLOROPHENOL	0.040	U	ug/L	0.040	OAO	11/08/00	11/06/00
515.1	PICLORAM	0.10	U	ug/L	0.10	OAO	11/08/00	11/06/00
515.1	2,4,5-TP (SILVEX)	0.20	U	ug/L	0.20	OAO	11/08/00	11/06/00
<u>DRINKING WATER ORGANIC CARBAMATES</u>								
531.1	CARBOPURAN	2.0	U	ug/L	2.0	LMA/KHA	11/06/00	
531.1	OXAMYL (VYDATE)	2.0	U	ug/L	2.0	LMA/KHA	11/06/00	
<u>DW DISINFECTANT BY-PRODUCTS</u>								
504.1	1,2-DIBROMO-3-CHLOROPROPANE	0.020	U	ug/L	0.020	OAO	11/03/00	11/03/00
504.1	ETHYLENE DIBROMIDE	0.010	U	ug/L	0.010	OAO	11/03/00	11/03/00
<u>DW MISC. SOC'S - GLYPHOSATE</u>								
547	GLYPHOSATE	6.0	U	ug/L	6.0	LB	11/02/00	
<u>DW MISC. SOC'S - ENDOTHALL</u>								
548.1	ENDOTHALL	9.0	U	ug/L	9.0	TKA	11/02/00	11/01/00
<u>DW MISC. SOC'S - DIQUAT</u>								
549.1	DIQUAT	0.40	U	ug/L	0.40	KHA	11/07/00	11/01/00
<u>DW ADIPATES, PHTHALATES, AND PAR'S</u>								
525.2	BENZO(A)PYRENE	0.10	U	ug/L	0.10	TKA	11/08/00	11/03/00
525.2	DI(2-ETHYLHEXYL)PHTHALATE	2.0	U	ug/L	2.0	TKA	11/08/00	11/03/00
525.2	DI(2-ETHYLHEXYL)ADIPATE	1.6	U	ug/L	1.6	TKA	11/08/00	11/03/00

MR. RICHARD MOUTON
 CITY OF FORT MYERS
 2751 JACKSONVILLE ST
 FORT MYERS, FL 33916



ANALYTICAL REPORT

Submission Number: 10000728
 Date Received: 10/31/00
 Date Reported: 12/05/00

Client's P.O. Number:
 Project Number:
 Project Name:
 Elab Report Name: Finalnew->Final2.RP1

Lab Sample Number: 0010728 1
 Client Sample Number:
 Sample Description: DEEP WELL P7

Date Sampled: 10/30/00
 Sample Matrix: DRINKING WATER

Method	Analyte	Result	Q	Units	Limit	Reporting Analyst	Date Analyzed	Prepared
420.2	TOTAL RECOVERABLE PHENOLICS	0.010	U	mg/L	0.010	KFE	11/03/00	
SM2120B	COLOR	5.0	U	UNIT	5.0	MRO	10/31/00	17:50
120.1	SPECIFIC CONDUCTANCE	3640		umhos/cm	1.0	MRO	10/31/00	
SM2150B	ODOR	2.0		TON	1.0	MRO	10/31/00	17:54
150.1	PH	7.40		UNIT	N/A	MRO	10/31/00	17:45
SM2540C	TOTAL DISSOLVED SOLIDS (TDS)	2200		mg/L	5.0	MRO	11/01/00	
SM4500CN-B	CYANIDE - TOTAL	0.010	U	mg/L	0.010	TPE	11/07/00	
370.1	DISSOLVED SILICA	16		mg/L	1.0	KFE	11/03/00	
310.1	HYDROXIDE A.K.A. as CaCO3	5.0	U	mg/L	5.0	RFI	11/06/00	
SM4500NH3D	AMMONIA NITROGEN (as N)	0.42		mg/L	0.050	TPE	11/01/00	
415.1	TOTAL ORGANIC CARBON (TOC)	1.0	U	mg/L	1.0	MMA	11/12/00	
SM6540C	SURFACTANTS (MBAS)	0.10	U	mg/L	0.10	KFE	11/01/00	16:00
900.0	GROSS ALPHA	6.0+/-3.8	U	pCi/L	6.0+/-3.8	MJN	11/07/00	
903.1	RADIUM 226	1.2+/-0.3		pCi/L		MJN	11/13/00	
EPA ALI	RADIUM 228	1.0+/-0.7	U	pCi/L	1.0+/-0.7	MJN	11/13/00	
300.0	CHLORIDE	940		mg/L	0.50	KFE	11/01/00	
300.0	FLUORIDE	1.6		mg/L	0.050	KFE	10/31/00	17:42
300.0	NITRATE NITROGEN (as N)	0.050	U	mg/L	0.050	KFE	10/31/00	17:42
300.0	NITRITE NITROGEN (as N)	0.050	U	mg/L	0.050	KFE	11/01/00	
300.0	SULFATE	370		mg/L	0.50	KFE	11/01/00	
SM4500C1-D	CHLORINE DEMAND	9.6		mg/L	0.020	JB	10/31/00	
	TIME - INCUBATION (SDS)	168		HOURS	N/A	JB	10/31/00	
SM4500C1G	CHLORINE DOSE (SD6) (ICR only)	24		mg/L	0.050	JB	10/31/00	
SM4500C1C	FREE RESIDUAL CHLORINE (SDS)	3.9		mg/L	0.050	SY	11/07/00	
150.1	PH - BUFFERED (SDS)	7.16		UNIT	N/A	JB	10/31/00	
SM2550B	TEMPERATURE - INCUBATION (SDS)	25.0		DEG C	N/A	JB	10/31/00	
SM3113B	ANTIMONY (TOTAL)	3.0	U	ug/L	3.0	EM	11/06/00	
SM3113B	LEAD (TOTAL)	1.2		ug/L	1.0	JAS	11/03/00	
245.1	MERCURY	0.20	U	ug/L	0.20	JAS	11/02/00	
SM3113B	SELENIUM (TOTAL)	2.0	U	ug/L	2.0	EM	11/07/00	
200.9	THALLIUM (TOTAL)	1.0	U	ug/L	1.0	JAS	11/03/00	
200.7	ALUMINUM (TOTAL)	100	U	ug/L	100	JAS	11/02/00	

MR. RICHARD MOULTON
 CITY OF FORT MYERS
 2751 JACKSONVILLE ST
 FORT MYERS, FL 33916



ANALYTICAL REPORT

Submission Number: 10000728
 Date Received: 10/31/00
 Date Reported: 12/05/00

Client's P.O. Number:
 Project Number:
 Project Name:
 Elab Report Name: Finalnew->Final2.RP1

Lab Sample Number: 0010728 1
 Client Sample Number:
 Sample Description: DEEP WELL P7

Date Sampled: 10/30/00
 Sample Matrix: DRINKING WATER

Method	Analyte	Result	Q	Units	Reporting Limit	Analyst	Date Analyzed	Prepared
200.7	ARSENIC (TOTAL)	5.0	U	ug/L	5.0	JAS	11/02/00	
200.7	BARIUM (TOTAL)	27		ug/L	10	JAS	11/02/00	
200.7	BERYLLIUM (TOTAL)	1.0	U	ug/L	1.0	JAS	11/02/00	
200.7	CADMIUM (TOTAL)	1.0	U	ug/L	1.0	JAS	11/02/00	
200.7	CALCIUM (TOTAL)	110		mg/L	0.50	JAS	11/02/00	
200.7	CHROMIUM (TOTAL)	5.0	U	ug/L	5.0	JAS	11/02/00	
200.7	COPPER (TOTAL)	10	U	ug/L	10	JAS	11/02/00	
200.7	IRON (TOTAL)	40	U	ug/L	10	JAS	11/02/00	
200.7	MAGNESIUM (TOTAL)	95		mg/L	0.50	JAS	11/02/00	
200.7	MANGANESE (TOTAL)	5.0	U	ug/L	5.0	JAS	11/02/00	
200.7	NICKEL (TOTAL)	10	U	ug/L	10	JAS	11/02/00	
200.7	SILVER (TOTAL)	10	U	ug/L	10	JAS	11/02/00	
200.7	SODIUM (TOTAL)	430		mg/L	0.50	JAS	11/02/00	
200.7	ZINC (TOTAL)	20	U	ug/L	20	JAS	11/02/00	
200.7	STRONTIUM (TOTAL)	19000		ug/L	1000	JAS	11/06/00	
<u>PRIORITY POLLUTANT PEST, AND PCB'S</u>								
608	ALDRIN	0.0050	U	ug/L	0.0050	TCZ	11/07/00	11/01/00
608	a-BHC	0.0050	U	ug/L	0.0050	TCZ	11/07/00	11/01/00
608	b-BHC	0.020	U	ug/L	0.020	TCZ	11/07/00	11/01/00
608	d-BHC	0.020	U	ug/L	0.020	TCZ	11/07/00	11/01/00
608	g-BHC (LINDANE)	0.020	U	ug/L	0.020	TCZ	11/07/00	11/01/00
608	CHLORDANE (tech.)	0.50	U	ug/L	0.50	TCZ	11/07/00	11/01/00
608	4,4'-DDD	0.020	U	ug/L	0.020	TCZ	11/07/00	11/01/00
608	4,4'-DDE	0.020	U	ug/L	0.020	TCZ	11/07/00	11/01/00
608	4,4'-DDT	0.020	U	ug/L	0.020	TCZ	11/07/00	11/01/00
608	DIELDRIN	0.0050	U	ug/L	0.0050	TCZ	11/07/00	11/01/00
608	ENDOSULFAN I	0.020	U	ug/L	0.020	TCZ	11/07/00	11/01/00
608	ENDOSULFAN II	0.020	U	ug/L	0.020	TCZ	11/07/00	11/01/00
608	ENDOSULFAN SULFATE	0.020	U	ug/L	0.020	TCZ	11/07/00	11/01/00
608	ENDRIN	0.010	U	ug/L	0.010	TCZ	11/07/00	11/01/00
608	ENDRIN ALDEHYDE	0.020	U	ug/L	0.020	TCZ	11/07/00	11/01/00
608	HEPTACHLOR	0.020	U	ug/L	0.020	TCZ	11/07/00	11/01/00

MR. RICHARD MOULTON
 CITY OF FORT MYERS
 2751 JACKSONVILLE ST
 FORT MYERS, FL 33916



ANALYTICAL REPORT

Submission Number: 10000728 Client's P.O. Number:
 Date Received: 10/31/00 Project Number:
 Date Reported: 12/05/00 Project Name:
 Slab Report Name: Finalncw->Final2.RP1

Lab Sample Number: 0010728 1 Date Sampled: 10/30/00
 Client Sample Number: Sample Matrix: DRINKING WATER
 Sample Description: DEEP WELL P7

Method	Analyte	Result	Q	Units	Reporting Limit	Analyst	Date Analyzed	Prepared
<u>PRIORITY POLLUTANT PEST. AND PCB'S</u>								
608	HEPTACHLOR EPOXIDE	0.020	U	ug/L	0.020	TCZ	11/07/00	11/01/00
608	METHOXYCHLOR	0.020	U	ug/L	0.020	TCZ	11/07/00	11/01/00
608	TOXAPHENE	0.50	U	ug/L	0.50	TCZ	11/07/00	11/01/00
608	PCB 1016	0.50	U	ug/L	0.50	TCZ	11/07/00	11/01/00
608	PCB 1221	0.50	U	ug/L	0.50	TCZ	11/07/00	11/01/00
608	PCB 1232	0.50	U	ug/L	0.50	TCZ	11/07/00	11/01/00
608	PCB 1242	0.50	U	ug/L	0.50	TCZ	11/07/00	11/01/00
608	PCB 1248	0.50	U	ug/L	0.50	TCZ	11/07/00	11/01/00
608	PCB 1254	0.50	U	ug/L	0.50	TCZ	11/07/00	11/01/00
608	PCB 1260	0.50	U	ug/L	0.50	TCZ	11/07/00	11/01/00
<u>TRIALOMETHANES (TKMS)</u>								
502.2	BROMODICHLOROMETHANE	0.00050	U	mg/L	0.00050	RME	11/09/00	
502.2	BROMOFORM	0.00050	U	mg/L	0.00050	RME	11/09/00	
502.2	CHLORODIBROMOMETHANE	0.00050	U	mg/L	0.00050	RME	11/09/00	
502.2	CHLOROFORM	0.00050	U	mg/L	0.00050	RME	11/09/00	
502.2	TOTAL TRIHALOMETHANES	0.00050	U	mg/L	0.00050	RME	11/09/00	
HACH	RESIDUAL CHLORINE	2.0	U	mg/L	2.0	RME	11/09/00	
<u>TRIALOMETHANES (TKMS) - FP</u>								
330.2	RESIDUAL CHLORINE	2.0	U	mg/L	2.0	RME	11/10/00	
502.2	BROMODICHLOROMETHANE	0.0060	U	mg/L	0.00050	RME	11/10/00	
502.2	BROMOFORM	0.078	U	mg/L	0.00050	RME	11/10/00	
502.2	CHLORODIBROMOMETHANE	0.042	U	mg/L	0.00050	RME	11/10/00	
502.2	CHLOROFORM	0.0040	U	mg/L	0.00050	RME	11/10/00	
502.2	TOTAL TRIHALOMETHANES (FP)	0.13	U	mg/L	0.00050	RME	11/10/00	
<u>PRIORITY POLLUTANT VOLATILE ORGANICS</u>								
624	ACROLEIN	40	U	ug/L	40	JSA	11/07/00	
624	ACRYLONITRILE	40	U	ug/L	40	JSA	11/07/00	
624	BENZENE	2.0	U	ug/L	2.0	JSA	11/07/00	
624	BROMODICHLOROMETHANE	2.0	U	ug/L	2.0	JSA	11/07/00	
624	BROMOFORM	2.0	U	ug/L	2.0	JSA	11/07/00	
624	BROMOMETHANE	2.0	U	ug/L	2.0	JSA	11/07/00	

MR. RICHARD MOULTON
 CITY OF FORT MYERS
 2751 JACKSONVILLE ST
 FORT MYERS, FL 33916



ANALYTICAL REPORT

Submission Number: 10000728
 Date Received: 10/31/00
 Date Reported: 12/05/00

Client's P.O. Number:
 Project Number:
 Project Name:
 Elab Report Name: Finalncw->Final12.RP1

Lab Sample Number: 0010728 1
 Client Sample Number:
 Sample Description: DEEP WELL P7

Date Sampled: 10/30/00
 Sample Matrix: DRINKING WATER

Method	Analyte	Result	Q	Units	Reporting Limit	Analyst	Date Analyzed	Prepared
<u>PRIORITY POLLUTANT VOLATILE ORGANICS</u>								
624	CARBON TETRACHLORIDE	2.0	U	ug/L	2.0	JSA	11/07/00	
624	CHLOROBENZENE	2.0	U	ug/L	2.0	JSA	11/07/00	
624	CHLOROETHANE	2.0	U	ug/L	2.0	JSA	11/07/00	
624	2-CHLOROETHYL VINYL ETHER	20	U	ug/L	20	JSA	11/07/00	
624	CHLOROFORM	2.0	U	ug/L	2.0	JSA	11/07/00	
624	CHLOROMETHANE	2.0	U	ug/L	2.0	JSA	11/07/00	
624	DIBROMOCHLOROMETHANE	2.0	U	ug/L	2.0	JSA	11/07/00	
624	1,2-DICHLOROBENZENE	2.0	U	ug/L	2.0	JSA	11/07/00	
624	1,3-DICHLOROBENZENE	2.0	U	ug/L	2.0	JSA	11/07/00	
624	1,4-DICHLOROBENZENE	2.0	U	ug/L	2.0	JSA	11/07/00	
624	1,1-DICHLOROETHANE	2.0	U	ug/L	2.0	JSA	11/07/00	
624	1,2-DICHLOROETHANE	2.0	U	ug/L	2.0	JSA	11/07/00	
624	1,1-DICHLOROETHENE	2.0	U	ug/L	2.0	JSA	11/07/00	
624	trans-1,2-DICHLOROETHENE	2.0	U	ug/L	2.0	JSA	11/07/00	
624	1,2-DICHLOROPROPANE	2.0	U	ug/L	2.0	JSA	11/07/00	
624	cis-1,3-DICHLOROPROPENE	10	U	ug/L	10	JSA	11/07/00	
624	trans-1,3-DICHLOROPROPENE	10	U	ug/L	10	JSA	11/07/00	
624	ETHYLBENZENE	2.0	U	ug/L	2.0	JSA	11/07/00	
624	METHYLENE CHLORIDE	10	U	ug/L	10	JSA	11/07/00	
624	1,1,2,2-TETRACHLOROETHANE	2.0	U	ug/L	2.0	JSA	11/07/00	
624	TETRACHLOROETHENE	2.0	U	ug/L	2.0	JSA	11/07/00	
624	TOLUENE	2.0	U	ug/L	2.0	JSA	11/07/00	
624	1,1,1-TRICHLOROETHANE	2.0	U	ug/L	2.0	JSA	11/07/00	
624	1,1,2-TRICHLOROETHANE	2.0	U	ug/L	2.0	JSA	11/07/00	
624	TRICHLOROETHENE	2.0	U	ug/L	2.0	JSA	11/07/00	
624	TRICHLOROFLUOROMETHANE	2.0	U	ug/L	2.0	JSA	11/07/00	
624	VINYL CHLORIDE	2.0	U	ug/L	2.0	JSA	11/07/00	

MR. RICHARD HOULTON
 CITY OF FORT MYERS
 2751 JACKSONVILLE ST
 FORT MYERS, FL 33916



ANALYTICAL REPORT

Submission Number: 10000728
 Date Received: 10/31/00
 Date Reported: 12/05/00

Client's P.O. Number:
 Project Number:
 Project Name:
 Elab Report Name: Finalnew->Final2.RPI

Lab Sample Number: 0010728 1
 Client Sample Number:
 Sample Description: DEEP WELL P7
 Date Sampled: 10/30/00
 Sample Matrix: DRINKING WATER

Method	Analyte	Result	Q	Units	Reporting Limit	Analyst	Date Analyzed	Prepared
--------	---------	--------	---	-------	-----------------	---------	---------------	----------

PRIORITY POLLUTANT VOLATILE ORGANICS

Data Qualifier Code Key:

U - The analyte was analyzed for, but was not detected above the reported sample quantitation limit.

Lab Sample Number: 0010728 2
 Client Sample Number:
 Sample Description: DEEP WELL P1
 Date Sampled: 10/30/00
 Sample Matrix: DRINKING WATER

Method	Analyte	Result	Q	Units	Reporting Limit	Analyst	Date Analyzed	Prepared
--------	---------	--------	---	-------	-----------------	---------	---------------	----------

415.1	TOTAL ORGANIC CARBON (TOC)	1.0	U	mg/L	1.0	MMA	11/14/00	
SM4500C1-D	CHLORINE DEMAND	9.8		mg/L	0.020	JB	10/31/00	
	TIME - INCUBATION (SDS)	168		HOURS	N/A	JB	10/31/00	
SM4500C1G	CHLORINE DOSE (SDS) (ICR only)	24		mg/L	0.050	JB	10/31/00	
SM4500C1G	FREE RESIDUAL CHLORINE (SDS)	4.0		mg/L	0.050	SY	11/07/00	
150.1	pH - BUFFERED (SDS)	7.11		UNIT	N/A	JB	10/31/00	
SM2550B	TEMPERATURE - INCUBATION (SDS)	25.0		DEG C	N/A	JB	10/31/00	

TRIHALOMETHANES (THMS)

502.2	BROMODICHLOROMETHANE	0.00050	U	mg/L	0.00050	RME	11/09/00	
502.2	BROMOFORM	0.00050	U	mg/L	0.00050	RME	11/09/00	
502.2	CHLORODIBROMOMETHANE	0.00050	U	mg/L	0.00050	RME	11/09/00	
502.2	CHLOROFORM	0.00050	U	mg/L	0.00050	RME	11/09/00	
502.2	TOTAL TRIHALOMETHANES	0.00050	U	mg/L	0.00050	RME	11/09/00	
RACH	RESIDUAL CHLORINE	2.0	U	mg/L	2.0	RME	11/09/00	

TRIHALOMETHANES (THMS) - PP

330.2	RESIDUAL CHLORINE	2.0	U	mg/L	2.0	RME	11/10/00	
502.2	BROMODICHLOROMETHANE	0.0099		mg/L	0.00050	RME	11/10/00	
502.2	BROMOFORM	0.077		mg/L	0.00050	RME	11/10/00	
502.2	CHLORODIBROMOMETHANE	0.055		mg/L	0.00050	RME	11/10/00	

MR. RICHARD MOULTON
CITY OF FORT MYERS
2751 JACKSONVILLE ST
FORT MYERS, FL 33916



ANALYTICAL REPORT

Page 10

Submission Number: 10000728
Date Received: 10/31/00
Date Reported: 12/05/00

Client's P.O. Number:
Project Number:
Project Name:
Elab Report Name: Finalnew->Final2.RP1

Lab Sample Number: 0010728 2
Client Sample Number:
Sample Description: DEEP WELL P1

Date Sampled: 10/30/00
Sample Matrix: DRINKING WATER

Method	Analyte	Result Q	Units	Reporting Limit	Analyst	Date Analyzed	Prepared
502.2	<u>TRIALOMETHANES (THMS) - FP</u>						
502.2	CHLOROFORM	0.0052	mg/L	0.00050	RME	11/10/00	
502.2	TOTAL TRIHALOMETHANES (FP)	0.15	mg/L	0.00050	RME	11/10/00	

Data Qualifier Code Key:

U - The analyte was analyzed for, but was not detected above the reported sample quantitation limit.

CERTIFICATION: All analytical data reported above were obtained using the specified methods and were validated by our laboratory quality control system. This laboratory follows an approved quality assurance program.

Respectfully submitted:

A handwritten signature in black ink, appearing to read 'Paul K. Canevaro', written over a horizontal line.

Paul K. Canevaro
Laboratory Director



Elab, Inc.
 8 East Tower Circle
 Ormond Beach, FL 32174
 (904)672-5668 • FAX (904)673-4001

CHAIN OF CUSTODY RECORD

No. E **38086**

Page of

(INSTRUCTIONS ON BACK OF THIS FORM)

FOR LAB USE ONLY

Condition of Contents: _____

FOR LAB USE ONLY

Submission No. **10-728**

Temp. of Contents: _____

C (or Received on Ice, ROI)

Condition of Seals: _____

1. Client: (Company or Individual)
City of Font Myers

Address: **2751 Jacksonville St**

Phone: **(941) 332-6876**

18. Report Type:

City: **Font Myers** State: **FL** Zip Code: **33916**

FAX: **941) 332-6623**

- Routine
- Standard QC
- Datapackage

2. Report to: (if different from above)

Address: _____

Phone: () _____

19. Turnaround Time

City: _____ State: _____ Zip Code: _____

Fax: () _____

Standard

Rush: / /

3. Client Project Name:

Water Sample Codes (for Item 13)	Container Codes (for Item 16)
DW = Drinking Water	V = VOA vial
GW = Ground Water	G = glass
SW = Surface Water	P = plastic
PW = Processed Water	M = micro bag/cup
WW = Waste Water	O = other

4. Client Project No.:

5. P.O. No.:

6. Custody Seal No.:

7. Sampled By:

8. Shipping Method:

14. No. of Containers	15. Preservatives								
	16. Containers								
17. <i>Analyses Requested</i>									

Preservative Codex (for Item 15)

- C = Cool Only
- H = Hydrochloric Acid
- M = Monochloroacetic Acid
- N = Nitric Acid
- OH = Sodium Hydroxide
- S = Sulfuric Acid
- T = Sodium Thiosulfate

Item	9. Sample ID or No.	10. Sample Description	11.		12.		13.						20. REMARK	LAB USE ONLY LAB SAMPLE NO.	
			Date	Time	Comp	Grab	Water (Codes)	Air	Soil	Sludge	Other				
1		Deep Well P7	10/30/00	10:30			GW								
2															
3															
4															
5															
6															
7															
8															
9															
10															

MULTIPLE TESTS PER QUOTE BY MYRNA LUCKERT

(Note - Bacteriological sample was NOT taken)

(CAL)

21. RELINQUISHED BY	DATE	TIME	22. RECEIVED BY	DATE	TIME	FOR LAB USE ONLY
			P. Hagedorn	10/31	10:25	Sampling Fee: _____ Hrs.
						Equipment Rental Fee: _____
						Profile No.: _____ Quote No.: 1027



CASE NARRATIVE

LABORATORY: ELAB, Inc.
SUBMISSION NUMBER: 11000355
DATE RECEIVED: 11/14/00
DATE RESULTS REPORTED: 12/06/00

<p>I. Sample Receiving Activity All samples received intact and preserved with the following exception: The 40ml vials that were received for 601, 531, 547 and 504 analysis contained air bubbles.</p>
<p>II. Data N/A</p>
<p>III. Quality Control All Quality Control data meets the specified method criteria.</p>
<p>IV. Other Comments All the requested analysis were performed per client's request.</p>

PREPARED BY:

Myrna Luccert
Myrna Luccert, Project Manager

DATE: 12/8/00

V:\ADMIN\LETTERS\MYRNA\CASENAR\Cn11-355.DOC

APPENDIX K

**Bacteriological Analysis Results
for the Temporary Wellheads**



ENVIRONMENTAL QUALITY LAB
 1009 Tamiami Trail
 Port Charlotte, FL 33953
 DOH #85086

**DRINKING WATER
 BACTERIOLOGICAL ANALYSIS**

Press hard, (5) copies

FOR LAB USE ONLY

ANALYZED: Start 12/13 12:15 NK

LAB CERTIFICATION #85086

12/13

SYSTEM NAME: City of Ft Myers SYSTEM I.D. NO: FL 536 0102 SYSTEM PHONE #: 941 332 6976
 ADDRESS: 2751 Jacksonville St Ft Myers COUNTY: Lee DISTRICT: 5
 COLLECTOR: W. SPANGLER COLLECTOR PHONE # 941 458 4097

SAMPLE SITE (Locality or Subdivision): _____

DATE AND TIME COLLECTED: 12/12/2000 15:45 - 15:50

TYPE OF SUPPLY(Circle one): Community water system Noncommunity water system Nontransient - noncommunity water system
 Private well Swimming pool Bottled water Limited Use system

TYPE OF SAMPLE(Circle one): Compliance Repeat Replacement Main clearance Well survey Other well clearance
 (Check Box)
 Distribution Check here if payment made to county public health unit
 Raw

TO BE COMPLETED BY COLLECTOR OF SAMPLE			
COLL. NO.	SAMPLE POINT (Specific Address)	CL RES'D	pH
1 of 20	P-2 - 15:00 H		
	P-3 - 15:10 H		
	P-4 - 15:20 H		
	P-5 - 15:30 H		
	P-6 - 15:40 H		
✓	P-7 - 15:50 H		

TO BE COMPLETED BY LAB				
ANALYSIS METHOD: ME		MTF	MMO-MUG	PA
NON COLIFORM	*TOTAL	CONFIRM TOTAL	CONFIRM FECAL E. COLI	SAMPLE NUMBER
	A			21199
	A			21200
	A			21201
	A			21202
	A			21203
	A			21204

* Results in this column are presumptive. Total coliform and fecal coliform or E. coli confirmation will follow in 24-48 hours.

P - Coliforms are present C - Confluent growth TA - Turbid, Absence of gas or acid
 A - Coliforms are absent TNTC - Too numerous to count

INVOICE ADDRESS (if different than address below): _____ INTERPRETATIONS-REMARKS BY PROGRAM REVIEWER

Released By: W. Spangler Date & Time: 12/13 8:50H Received By: W. Spangler Date & Time: 08:00H 12/13/00
 Released By: W. Spangler Date & Time: 12/13 09:15H Received By: A. Kimpely Date & Time: 12-13-00

NAME AND MAILING ADDRESS OF PERSON/FIRM TO RECEIVE REPORT

- ()
- () SATISFACTORY
- () INCOMPLETE COLLECTION INFORMATION
- () REPEAT SAMPLES
- () REPLACEMENT SAMPLES

REVIEWING OFFICIAL: _____

TITLE: _____

DH 455, 1/97
 (Replaces 9/96 ed.)
 (Stock Number: 57)



ENVIRONMENTAL QUALITY LAB

1009 Tamiami Trail
Port Charlotte, FL 33953
DOH #85086

DRINKING WATER
BACTERIOLOGICAL ANALYSIS

FOR LAB USE ONLY
ANALYZED: Start 12/13 12:15 TLF
LAB CERTIFICATION #85086

Press hard, (5) copies

SYSTEM NAME: City of Ft Myers SYSTEM I.D. NO: FL 536 0102 SYSTEM PHONE #: 941 382 0924
ADDRESS: 2751 Jacksonville St Ft Myers COUNTY: Lee DISTRICT: 5
COLLECTOR: W. SPANGLE COLLECTOR PHONE #: 941-458 4097
SAMPLE SITE (Locality or Subdivision): Wells P-2 TO P-7
DATE AND TIME COLLECTED: 12/12/2000 9:10-9:50
TYPE OF SUPPLY(Circle one): Community water system Noncommunity water system Nontransient - noncommunity water system
Private well Swimming pool Bottled water Limited Use system
TYPE OF SAMPLE(Circle one): Compliance Repeat Replacement Main clearance Well survey Other Well clearance
[] Check here if payment made to county public health unit

Table with 2 main sections: 'TO BE COMPLETED BY COLLECTOR OF SAMPLE' and 'TO BE COMPLETED BY LAB'. Columns include COLL. NO., SAMPLE POINT, CL RES'D, pH, ANALYSIS METHOD, NON COLIFORM, *TOTAL, CONFIRM TOTAL, CONFIRM FECAL E. COLI, and SAMPLE NUMBER. Rows show sample points P-2 through P-7 with corresponding analysis results (A).

* Results in this column are presumptive. Total coliform and fecal coliform or E. coli confirmation will follow in 24-48 hours.

P - Coliforms are present C - Confluent growth TA - Turbid, Absence of gas or acid
A - Coliforms are absent TNTC - Too numerous to count

INVOICE ADDRESS (if different than address below):
Released By: W. Spangle Date & Time: 12/13 8:00 AM Received By: W. Spangle Date & Time: 12/13 09:00 AM
Released By: W. Spangle Date & Time: 12/13 09:15 AM Received By: W. Kingery Date & Time: 12/13-00

INTERPRETATIONS-REMARKS BY PROGRAM REVIEWER

NAME AND MAILING ADDRESS OF PERSON/FIRM TO RECEIVE REPORT

Empty box for name and mailing address of person/firm to receive report.

- ()
() SATISFACTORY
() INCOMPLETE COLLECTION INFORMATION
() REPEAT SAMPLES
() REPLACEMENT SAMPLES

REVIEWING OFFICIAL: _____

TITLE: _____

DOH 655-1/97 (Replaces 976 ed.) (Stock Number: 57)



ENVIRONMENTAL QUALITY LAB

1009 Tamiami Trail
Port Charlotte, FL 33953
DOH #85086

DRINKING WATER
BACTERIOLOGICAL ANALYSIS

FOR LAB USE ONLY
ANALYZED: Start 12/11 11:30 TK
LAB CERTIFICATION #85086

Press hard, (5) copies

SYSTEM NAME: City of Ft Myers SYSTEM I.D. NO: FL 536 0102 SYSTEM PHONE #: 941 332 6876
ADDRESS: 2757 Jacksonville St Ft Myers COUNTY: Lee DISTRICT: 5
COLLECTOR: W. Spangler COLLECTOR PHONE #: 941 458 4097
SAMPLE SITE (Locality or Subdivision): see below Wells # P2 -> P4
DATE AND TIME COLLECTED: 12/10/00 see time below. 9:15-10:05
TYPE OF SUPPLY(Circle one): Community water system Noncommunity water system Nontransient - noncommunity water system
Private well Swimming pool Bottled water Limited Use system
TYPE OF SAMPLE(Circle one): Compliance Repeat Replacement Main clearance Well survey Other Well clearance
[] Check here if payment made to county public health unit

Table with 4 columns: COLL. NO., SAMPLE POINT (Specific Address), CL RES'D, pH. Rows include Well # P-2, P-3, P-4, P-5, P-6, P-7.

Table with 5 columns: ANALYSIS METHOD (NON COLIFORM, *TOTAL, CONFIRM TOTAL, CONFIRM FECAL E. COLI, MMO-MUG, PA). Rows correspond to sample numbers 21151-21156.

* Results in this column are presumptive. Total coliform and fecal coliform or E. coli confirmation will follow in 24-48 hours.

P - Coliforms are present C - Confluent growth TA - Turbid, Absence of gas or acid
A - Coliforms are absent TNTC - Too numerous to count
INVOICE ADDRESS (if different than address below):
Released By: W. Spangler Date & Time: 12/10/00 - 10:15 Received By: A. Kirby Date & Time: 12-11-00

NAME AND MAILING ADDRESS OF PERSON/FIRM TO RECEIVE REPORT

() SATISFACTORY
() INCOMPLETE COLLECTION INFORMATION
() REPEAT SAMPLES
() REPLACEMENT SAMPLES
REVIEWING OFFICIAL:
TITLE:

in may be used
DH 455, 1/97
Replaces 9/96 ed/ii
Stock Number: 574



ENVIRONMENTAL QUALITY LAB

1009 Tamiami Trail
Port Charlotte, FL 33953
DOH #85086

DRINKING WATER
BACTERIOLOGICAL ANALYSIS

Press hard, (5) copies

FOR LAB USE ONLY
ANALYZED: Start 12/11 1130 RF
LAB CERTIFICATION #85086

Handwritten initials/signature

SYSTEM NAME: City of Ft Myers SYSTEM I.D. NO: FL 586 0102 SYSTEM PHONE #: 941 332 6876
ADDRESS: 2751 Jacksonville St Ft Myers COUNTY: Lee DISTRICT: 5
COLLECTOR: W Spangle COLLECTOR PHONE #: 941 425 3137
SAMPLE SITE (Locality or Subdivision): See below. Wells # P2 -> P7
DATE AND TIME COLLECTED: 12/10/00 See time below 15:40 - 1630
TYPE OF SUPPLY (Circle one): Community water system Noncommunity water system Nontransient - noncommunity water system
Private well Swimming pool Bottled water Limited Use system
TYPE OF SAMPLE (Circle one): Compliance Repeat Replacement Main clearance Well survey Other Well clearances
[] Check here if payment made to county public health unit

Table with 4 columns: COLL. NO., SAMPLE POINT (Specific Address), CI RES'D, pH. Contains handwritten entries for wells P-2 through P-7.

Table with 5 columns: ANALYSIS METHOD (MF, MTF, MMO-MUG, PA), NON COLIFORM, *TOTAL, CONFIRM TOTAL, CONFIRM FECAL E. COLI, SAMPLE NUMBER. Contains handwritten data for samples 21157-21162.

* Results in this column are presumptive. Total coliform and fecal coliform or E. coli confirmation will follow in 24-48 hours.

P - Coliforms are present C - Confluent growth TA - Turbid, Absence of gas or acid
A - Coliforms are absent TNTC - Too numerous to count

INVOICE ADDRESS (if different than address below):
Released By: W. Spangle Date & Time: 12/11/00 - 10:55 Received By: A. Kumpen Date & Time: 12-11-00

NAME AND MAILING ADDRESS OF PERSON/FIRM TO RECEIVE REPORT

Empty box for recipient name and mailing address.

- () SATISFACTORY
() INCOMPLETE COLLECTION INFORMATION
() REPEAT SAMPLES
() REPLACEMENT SAMPLES

REVIEWING OFFICIAL: _____

TITLE: _____

DM 455, 1/97 (Replaces 9/96 ed. (Stock Number: 57) -0655-5)



ENVIRONMENTAL QUALITY LAB

1009 Tamiami Trail
Port Charlotte, FL 33953
DOH #85086

DRINKING WATER BACTERIOLOGICAL ANALYSIS

FOR LAB USE ONLY

ANALYZED:

Start
12/11
1130
TZF

5
12/11/00

LAB CERTIFICATION #85086

Press hard, (5) copies

SYSTEM NAME: City of Ft Myers SYSTEM I.D. NO: FL 5360102 SYSTEM PHONE #: 941 332 6874
ADDRESS: 2751 Jacksonville ST Ft Myers COUNTY: Lee DISTRICT: 5
COLLECTOR: W. SPANGLER COLLECTOR PHONE #: 941 625 3137
SAMPLE SITE (Locality or Subdivision): See below. Wells # P2 -> P7
DATE AND TIME COLLECTED: 12/11/00 See time below

TYPE OF SUPPLY(Circle one): Community water system Noncommunity water system Nontransient - noncommunity water system
Private well Swimming pool Bottled water Limited Use system

TYPE OF SAMPLE(Circle one): Compliance Repeat Replacement Main clearance Well survey Other Well clearance
(Check Box)
 J-Distribution Check here if payment made to county public health unit
 Raw

TO BE COMPLETED BY COLLECTOR OF SAMPLE

TO BE COMPLETED BY LAB

COLL. NO.	SAMPLE POINT (Specific Address)	CL RES'D	pH
20	Well # P2 - 8:45 H		
	P3 - 8:55 H		
	P4 - 9:05 H		
	P5 - 9:15 H		
	P6 - 9:25 H		
	P7 - 9:35 H		

ANALYSIS METHOD: MF		MTF	MMO-MUG	PA
NON COLIFORM	*TOTAL	CONFIRM TOTAL	CONFIRM FECAL E. COLI	SAMPLE NUMBER
	A			21163
	A			21164
	A			21165
	A			21166
	A			21167
	A			21168

* Results in this column are presumptive. Total coliform and fecal coliform or E. coli confirmation will follow in 24-48 hours.

P - Coliforms are present
A - Coliforms are absent

C - Confluent growth
TNTC - Too numerous to count

TA - Turbid, Absence of gas or acid

INVOICE ADDRESS (if different than address below):

INTERPRETATIONS-REMARKS BY PROGRAM REVIEWER

Released By: W. Spangler Date & Time: 12/11/00 - 10:15 Received By: A. Kinoshita Date & Time: 12-11-00

Released By: _____ Date & Time: _____ Received By: _____ Date & Time: _____

NAME AND MAILING ADDRESS OF PERSON/FIRM TO RECEIVE REPORT

- ()
- () SATISFACTORY
- () INCOMPLETE COLLECTION INFORMATION
- () REPEAT SAMPLES
- () REPLACEMENT SAMPLES

REVIEWING OFFICIAL: _____

TITLE: _____

DH 655-1/97
(Replaces 9/96 ed.)
(Stock Number: 574)



ENVIRONMENTAL QUALITY LAB

1009 Tamiami Trail
Port Charlotte, FL 33953
DOH #85086

DRINKING WATER
BACTERIOLOGICAL ANALYSIS

Press hard, (5) copies

FOR LAB USE ONLY
ANALYZED: Start 12/9 1815
LAB CERTIFICATION #85086

5418

SYSTEM NAME: City of Fort Myers SYSTEM I.D. NO: FL5360102 SYSTEM PHONE #: 941-332-6876
ADDRESS: 2751 Gibsonville St Ft Myers 33916 COUNTY: Lee DISTRICT: 5
COLLECTOR: Wm Spangle COLLECTOR PHONE #: 941-458-4097
SAMPLE SITE (Locality or Subdivision): See below: Wells # P-2 thru # P-7
DATE AND TIME COLLECTED: 12/08/00 See TIME below.
TYPE OF SUPPLY(Circle one): Community water system Noncommunity water system Nontransient - noncommunity water system
Private well Swimming pool Bottled water Limited Use system
TYPE OF SAMPLE(Circle one): Compliance Repeat Replacement Main clearance Well survey Other
[] Check here if payment made to county public health unit

Table with 4 columns: COLL. NO., SAMPLE POINT (Specific Address), CI RES'D, pH. Rows include Well # P2 1600H, P3 1610H, P4 1620H, P5 1630H, P6 1640H, P7 1650H.

Table with 5 columns: ANALYSIS METHOD: MF, MTF, MMO-MUG, PA. Rows include NON COLIFORM, *TOTAL, CONFIRM TOTAL, CONFIRM FECAL E. COLI, SAMPLE NUMBER. Results are mostly 'A'.

* Results in this column are presumptive. Total coliform and fecal coliform or E. coli confirmation will follow in 24-48 hours.

P - Coliforms are present C - Confluent growth TA - Turbid, Absence of gas or acid
A - Coliforms are absent TNTC - Too numerous to count

INVOICE ADDRESS (if different than address below): INTERPRETATIONS-REMARKS BY PROGRAM REVIEWER
Released By: W. Spangle Date & Time: 12/09/00 1700H Received By: W. Spangle Date & Time: 12/08/00 1700H

NAME AND MAILING ADDRESS OF PERSON/FIRM TO RECEIVE REPORT

Empty box for name and mailing address.

- () SATISFACTORY
() INCOMPLETE COLLECTION INFORMATION
() REPEAT SAMPLES
() REPLACEMENT SAMPLES

REVIEWING OFFICIAL: _____

TITLE: _____

OH 455-1/97 Replaces 9/96 ed. (Stock Number: 57)



ENVIRONMENTAL QUALITY LAB

1009 Tamiami Trail
Port Charlotte, FL 33953
DOH #85086

DRINKING WATER
BACTERIOLOGICAL ANALYSIS

Press hard, (5) copies

FOR LAB USE ONLY
ANALYZED: Start 12/19 1815 TRK 5418
LAB CERTIFICATION #85086

SYSTEM NAME: City of Fort Myers SYSTEM I.D. NO: FL5360102 SYSTEM PHONE #: 941-332-6876
ADDRESS: 2751 Jacksonville St. Ft Myers 33916 COUNTY: Lee DISTRICT: 5
COLLECTOR: Wm Spangle COLLECTOR PHONE #: 941-458-4097
SAMPLE SITE (Locality or Subdivision): see below: Wells # P-2 thru # P-7.
DATE AND TIME COLLECTED: 12.09.00 see below for time
TYPE OF SUPPLY(Circle one): Community water system Noncommunity water system Nontransient - noncommunity water system
Private well Swimming pool Bottled water Limited Use system
TYPE OF SAMPLE(Circle one): Compliance Repeat Replacement Main clearance Well survey Other Well Clearance
[] Check here if payment made to county public health unit

Table with 4 columns: COLL. NO., SAMPLE POINT (Specific Address), CL RES'D, pH. Rows include Well # P2 0815H, P3 0825H, P4 0835H, P5 0845H, P6 0855H, P7 0905H.

Table with 5 columns: ANALYSIS METHOD: MF, MTF, MMO-MUG, PA. Rows include *TOTAL, CONFIRM, FECAL E. COLI, SAMPLE NUMBER. Values include A, 21175, 21176, 21177, 21178, 21179, 21180.

* Results in this column are presumptive. Total coliform and fecal coliform or E. coli confirmation will follow in 24-48 hours.

P - Coliforms are present C - Confluent growth TA - Turbid, Absence of gas or acid
A - Coliforms are absent TNC - Too numerous to count
INVOICE ADDRESS (if different than address below):
Released By: Wm Spangle Date & Time: 12/09/00 Received By: Wm Spangle Date & Time: 12/09/00

NAME AND MAILING ADDRESS OF PERSON/FIRM TO RECEIVE REPORT

- () SATISFACTORY
() INCOMPLETE COLLECTION INFORMATION
() REPEAT SAMPLES
() REPLACEMENT SAMPLES

REVIEWING OFFICIAL:
TITLE:

DOH 855-1/97
Replaces 9/96 edit
Stock Number: 57.



ENVIRONMENTAL QUALITY LAB

1009 Tamiami Trail
Port Charlotte, FL 33953
DOH #85086

DRINKING WATER
BACTERIOLOGICAL ANALYSIS

Press hard, (5) copies

FOR LAB USE ONLY
ANALYZED: Start 12/19 1815 TF
LAB CERTIFICATION #85086

5418

SYSTEM NAME: City of York Myers SYSTEM I.D. NO: FL 536 0102 SYSTEM PHONE #: 941-332-6876
ADDRESS: 2751 Gallesville St Ft. Myers FL 33916 COUNTY: DISTRICT:
COLLECTOR: Wm Spangle COLLECTOR PHONE #: 941-458-14097
SAMPLE SITE (Locality or Subdivision): See below. Wells # P-2 thru # P-7.
DATE AND TIME COLLECTED: 12.09.00 See time below.
TYPE OF SUPPLY(Circle one): Community water system Noncommunity water system Nontransient - noncommunity water system
Private well Swimming pool Bottled water Limited Use system
TYPE OF SAMPLE(Circle one): Compliance Repeat Replacement Main clearance Well survey Other Well Clearance
[] Check here if payment made to county public health unit

Table with 4 columns: COLL. NO., SAMPLE POINT (Specific Address), CL RES'D, pH. Rows include Well # P2 1500H, P3 1510H, P4 1520H, P5 1530H, P6 1540H, P7 1550H.

Table with 5 columns: ANALYSIS METHOD (MF), CONFIRM TOTAL, CONFIRM FECAL E. COLI, MMO-MUG, PA. Rows show sample numbers 21181 through 21186 with 'A' in the CONFIRM TOTAL column.

* Results in this column are presumptive. Total coliform and fecal coliform or E. coli confirmation will follow in 24-48 hours.

P - Coliforms are present C - Confluent growth TA - Turbid, Absence of gas or acid
A - Coliforms are absent TNTC - Too numerous to count
INVOICE ADDRESS (if different than address below):
Released By: W. Spangle Date & Time: 12/09/00 1700H Received By: W. Spangle Date & Time: 12/09/00 1700H

NAME AND MAILING ADDRESS OF PERSON/FIRM TO RECEIVE REPORT
[Empty box for name and address]

- () SATISFACTORY
() INCOMPLETE COLLECTION INFORMATION
() REPEAT SAMPLES
() REPLACEMENT SAMPLES

REVIEWING OFFICIAL:
TITLE:

OH 455, 1/97
Replaces 9/96 ed
Stock Number: 57



ENVIRONMENTAL QUALITY LAB

1009 Tamiami Trail
Port Charlotte, FL 33953
DOH #85086

DRINKING WATER
BACTERIOLOGICAL ANALYSIS

FOR LAB USE ONLY
ANALYZED: Start 12/7 1330 TK
LAB CERTIFICATION #85086

Press hard, (5) copies

SYSTEM NAME: City of Fort Myers SYSTEM I.D. NO: FL 536010 2 SYSTEM PHONE #: 941 332 6876
ADDRESS: 2751 Jacksonville St Ft. Myers 33916 COUNTY: Lee DISTRICT: 5
COLLECTOR: Noah Olenych COLLECTOR PHONE #: 941 625 3137
SAMPLE SITE (Locality or Subdivision): Well P-2
DATE AND TIME COLLECTED: 12/7/00 1010

TYPE OF SUPPLY(Circle one): Community water system Noncommunity water system Nontransient - noncommunity water system
Private well Swimming pool Bottled water Limited Use system
TYPE OF SAMPLE(Circle one): Compliance Repeat Replacement Main clearance Well survey Other Well Clearance
[] Distribution [] Check here if payment made to county public health unit
Raw

1 of 20

Table with 4 columns: COLL. NO., SAMPLE POINT (Specific Address), CI RES'D, pH. Row 1: 1, P-2, 0.0, []

Table with 5 columns: ANALYSIS METHOD (MF, MTF, MMO-MUG, PA), NON COLIFORM, *TOTAL, CONFIRM TOTAL, CONFIRM FECAL E. COLI, SAMPLE NUMBER. Row 1: MF, A, [], [], 21133

* Results in this column are presumptive. Total coliform and fecal coliform or E. coli confirmation will follow in 24-48 hours.

P - Coliforms are present C - Confluent growth TA - Turbid, Absence of gas or acid
A - Coliforms are absent TNC - Too numerous to count

INVOICE ADDRESS (if different than address below): INTERPRETATIONS-REMARKS BY PROGRAM REVIEWER
Released By: Noah Olenych Date & Time: 12/7 1230 Received By: Date & Time:
Released By: Date & Time: Received By: Date & Time:

NAME AND MAILING ADDRESS OF PERSON/FIRM TO RECEIVE REPORT

- () SATISFACTORY
() INCOMPLETE COLLECTION INFORMATION
() REPEAT SAMPLES
() REPLACEMENT SAMPLES

REVIEWING OFFICIAL: _____

TITLE: _____

SH may be used
455-51
DH 455, 1/97
(Replaces 9/96 ed.)
Stock Number: 57



ENVIRONMENTAL QUALITY LAB
 1009 Tamiami Trail
 Port Charlotte, FL 33953
 DOH #85086

**DRINKING WATER
 BACTERIOLOGICAL ANALYSIS**

Press hard, (5) copies

FOR LAB USE ONLY

ANALYZED: Start 1217
1330
TRK

LAB CERTIFICATION #85086

5/2/18

SYSTEM NAME: City of Fort Myers SYSTEM I.D. NO: FL 5360102 SYSTEM PHONE #: 941 332 6876
 ADDRESS: 2751 Jacksonville St. Ft. Myers FL 33916 COUNTY: Lee DISTRICT: 5
 COLLECTOR: Noah Olneych COLLECTOR PHONE #: 941 625 3135
 SAMPLE SITE (Locality or Subdivision): Well P-3
 DATE AND TIME COLLECTED: 12/7/00 1020

TYPE OF SUPPLY(Circle one): Community water system Noncommunity water system Nontransient - noncommunity water system
 Private well Swimming pool Bottled water Limited Use system

TYPE OF SAMPLE(Circle one): Compliance Repeat Replacement Main clearance Well survey Other Well Clearance
 (Check Box) [] Distribution [X] Raw

1 of 20 [] Check here if payment made to county public health unit

TO BE COMPLETED BY COLLECTOR OF SAMPLE			
COLL. NO.	SAMPLE POINT (Specific Address)	CL RES'D	pH
1	P-3	00	

TO BE COMPLETED BY LAB				
ANALYSIS METHOD: MF		MTF	MMO-MUG	PA
NON COLIFORM	*TOTAL	CONFIRM TOTAL	CONFIRM FECAL E. COLI	SAMPLE NUMBER
	A			21134

* Results in this column are presumptive. Total coliform and fecal coliform or E. coli confirmation will follow in 24-48 hours.

P - Coliforms are present C - Confluent growth TA - Turbid, Absence of gas or acid
 A - Coliforms are absent TNIC - Too numerous to count

INVOICE ADDRESS (if different than address below): _____ INTERPRETATIONS-REMARKS BY PROGRAM REVIEWER _____

Released By: Noah Olneych Date & Time: 12/7/00 Received By: _____ Date & Time: _____
 Released By: _____ Date & Time: _____ Received By: _____ Date & Time: _____

NAME AND MAILING ADDRESS OF PERSON/FIRM TO RECEIVE REPORT

- ()
- () SATISFACTORY
- () INCOMPLETE COLLECTION INFORMATION
- () REPEAT SAMPLES
- () REPLACEMENT SAMPLES

REVIEWING OFFICIAL: _____
 TITLE: _____

DH 655, 1/97
 (Replaces 9/96 ed.)
 (Stock Number: 57-0655-5)



ENVIRONMENTAL QUALITY LAB

1009 Tamiami Trail
Port Charlotte, FL 33953
DOH #85086

DRINKING WATER
BACTERIOLOGICAL ANALYSIS

FOR LAB USE ONLY

ANALYZED:

Start 12/7
13:30 TLF

Handwritten circled number 57/18

LAB CERTIFICATION #85086

Press hard, (5) copies

SYSTEM NAME: City of Fort Myers SYSTEM I.D. NO: FL 5360102 SYSTEM PHONE #: 941 332 687

ADDRESS: 2751 Jacksonville St Ft. Myers 33916 COUNTY: Lee DISTRICT: 5

COLLECTOR: Noah Olneyh COLLECTOR PHONE #: 941 625 3137

SAMPLE SITE (Locality or Subdivision): P-4

DATE AND TIME COLLECTED: 12/7/00 1025

TYPE OF SUPPLY(Circle one): Community water system Noncommunity water system Nontransient - noncommunity water system
Private well Swimming pool Bottled water Limited Use system

TYPE OF SAMPLE(Circle one): Compliance Repeat Replacement Main clearance Well survey Other Well Clearance
[] Distribution [] Check here if payment made to county public health unit
[X] Raw 1 of 20

Table with 4 columns: COLL. NO., SAMPLE POINT (Specific Address), CI RES'D, pH. Row 1: 1, P-4, 0.0, []

Table with 5 columns: ANALYSIS METHOD (NON COLIFORM, *TOTAL, CONFIRM TOTAL, CONFIRM FECAL E. COLI, SAMPLE NUMBER). Row 1: A, [], [], [], 21135

* Results in this column are presumptive. Total coliform and fecal coliform or E. coli confirmation will follow in 24-48 hours.

P - Coliforms are present C - Confluent growth TA - Turbid, Absence of gas or acid
A - Coliforms are absent TNTC - Too numerous to count

INVOICE ADDRESS (if different than address below): INTERPRETATIONS-REMARKS BY PROGRAM REVIEWER
Released By: Noah Olneyh Date & Time: 12/7 1230 Received By: Date & Time:
Released By: Date & Time: Received By: Date & Time:

NAME AND MAILING ADDRESS OF PERSON/FIRM TO RECEIVE REPORT

Empty box for name and mailing address

- () SATISFACTORY
() INCOMPLETE COLLECTION INFORMATION
() REPEAT SAMPLES
() REPLACEMENT SAMPLES

REVIEWING OFFICIAL: _____

TITLE: _____

Vertical text on the left margin: (ch may be used) X655-5; DH 453, 1/97 (Replaces 9796 ed) (Stock Number: 5)



ENVIRONMENTAL QUALITY LAB

1009 Tamiami Trail
Port Charlotte, FL 33953
DOH #85086

**DRINKING WATER
BACTERIOLOGICAL ANALYSIS**

FOR LAB USE ONLY

ANALYZED:

Start
12/7
1330
TK

5/1/8

LAB CERTIFICATION #85086

Press hard, (5) copies

SYSTEM NAME: City of Fort Myers SYSTEM I.D. NO: FL530102 SYSTEM PHONE #: 941 332 6876
ADDRESS: 2751 Jacksonville St. Ft. Myers 33916 COUNTY: Lee DISTRICT: 5
COLLECTOR: Noah Olenych COLLECTOR PHONE #: 941 625 3137
SAMPLE SITE (Locality or Subdivision): Well P-5
DATE AND TIME COLLECTED: 12/7/00 1030

TYPE OF SUPPLY(Circle one): Community water system Noncommunity water system Nontransient - noncommunity water system
Private well Swimming pool Bottled water Limited Use system
TYPE OF SAMPLE(Circle one): Compliance Repeat Replacement Main clearance Well survey Other _____
(Check Box) [] Distribution [X] Raw P-5 1 of 20 [] Check here if payment made to county public health unit

TO BE COMPLETED BY COLLECTOR OF SAMPLE			
COLL. NO.	SAMPLE POINT (Specific Address)	CL RES'D	pH
1	P-5	0.0	

TO BE COMPLETED BY LAB				
ANALYSIS METHOD: MF		MTF	MMO-MUG	PA
NON COLIFORM	*TOTAL	CONFIRM TOTAL	CONFIRM FECAL E. COLI	SAMPLE NUMBER
	A			21136

* Results in this column are presumptive. Total coliform and fecal coliform or E. coli confirmation will follow in 24-48 hours.

P - Coliforms are present C - Confluent growth TA - Turbid, Absence of gas or acid
A - Coliforms are absent TNTC - Too numerous to count

INVOICE ADDRESS (if different than address below): _____ INTERPRETATIONS-REMARKS BY PROGRAM REVIEWER _____
Released By: Noah Olenych Date & Time: 12/7 1230 Received By: _____ Date & Time: _____
Released By: _____ Date & Time: _____ Received By: _____ Date & Time: _____

NAME AND MAILING ADDRESS OF PERSON/FIRM TO RECEIVE REPORT

[Empty box for name and mailing address]

- ()
- () SATISFACTORY
- () INCOMPLETE COLLECTION INFORMATION
- () REPEAT SAMPLES
- () REPLACEMENT SAMPLES

REVIEWING OFFICIAL: _____

TITLE: _____

DH 455, 1/97
Replaces 9/96 ed
Stock Number: 57
ich may be used
0455-5)